

# Living Schoolyard Guidelines

—  
**OUSD 2022**



**BAY TREE DESIGN**



# Acknowledgements

The creation of these Guidelines was funded by a grant from Trust for Public Land.

The Guidelines were created with representatives from several OUSD departments and OUSD school sites including Facilities, Buildings and Grounds, Custodial, Community Schools and Students Services, Health and Wellness, Risk Management and Legal, Academic Innovation, the OUSD Garden Council, principals, teachers, students, and the OUSD Health and Wellness/Education and Community Programming Team @ The Center. Common Vision, Growing Together, Trees of Oakland, The Watershed Project, and other non-profit organizations provided their expertise and guidance in the creation of the final document. Trust for Public Land, BAY TREE DESIGN, Green Schoolyards America, Lotus Water, Brookwater, and DIALOG developed the document working closely with all these representatives.

## Contributors:

The list below includes all people who have contributed to the design guidelines:

Patricia Barros, OUSD

Olga Bermeo, OUSD

Roland Broach, OUSD

Gina Brouwer, New Leaf

Andrea Bustamante, OUSD

Mark Cavalli, OUSD

Kenya Chatham, OUSD

Alejandra Chiesa, Green Schoolyards America

Cam Collyer, People and Places

Josh Daniels, OUSD

Sharon Danks, Green Schoolyards America

Sam Davis, OUSD

Nancy Deming, OUSD

Aurore Develay, BAY TREE DESIGN

Shauna Dunton, Lotus Water

Ayesha Ercelawn, Green Schoolyards America

Lauren Freels, BAY TREE DESIGN

Carlos Grifo Anton, DIALOG

Trudy Garber, Trust for Public Land

Manuel Garcia, OUSD

Deon Guillory II, OUSD

Brendan Havenar-Daughton, OUSD

Lisa Howard, BAY TREE DESIGN

Dong Kim, DIALOG

Jean-Luc Keita, OUSD

Grey Kolevzon, Growing Together

Mary Ledezma, OUSD

Rebecca Littlejohn, OUSD

Janet Luehrs, Brookwater

Suzanne Ludlum, OUSD

Kira Maritano, Trust for Public Land

Amy McCosh Leonard, Trust for Public Land

Tadashi Nakadegawa, OUSD

Michelle Oppen, OUSD

Allison Petsod Hixson, OUSD

Sarah Pipping, OUSD

Rachel Pringle, Green Schoolyards America

Jose Luis Rodriquez, Growing Together

Marion Riggs, Marion Riggs Graphic Design

Kat Romo, OUSD

Curtis Sarikey, OUSD

Kat Sawyer, The Watershed Project

Derek Schubert, Trees for Oakland

Arran Schulz, BAY TREE DESIGN

Sarah Selvidge, OUSD Parent and Garden Steward

Lee Sims, OUSD

Wanda Stewart, Common Vision

Marc White, OUSD

Annie Youngerman, Trust for Public Land

Mika Zelie, OUSD



## 00.

### Introduction

INTENT OF GUIDELINES	5
LIVING SCHOOLYARDS DEFINITION & GOALS	7

## 01.

### Design Principles

DEVELOP OUTDOOR ENVIRONMENTS THAT SUPPORT LEARNING	9
CREATE LANDSCAPES FOR CHILD DEVELOPMENT	11
DESIGN FOR EQUITY	12
STRENGTHEN ENVIRONMENTAL RESILIENCE	14
BUILD EXISTING ASSETS	15
CONSIDER MAINTENANCE	16

## 02.

### Design Components

GENERAL AREAS IN A SCHOOLYARD	18
APPLICABLE CODES & POLICIES	23
COMPONENTS & MATERIALS	24
SITE GRADING	26
PAVING AND SURFACING	30
RESILIENT PAVING	42
SITE FURNISHINGS	48
FENCING	59
PLAY EQUIPMENT	62
LANDSCAPING	65
SIGNAGE	72

## 03.

### Process

PROJECT TYPES	74
PROJECT PHASES	75
OUSD, DSA, & AHJ APPROVAL PROCESSES	78

## 04.

### Maintenance & Stewardship

INTRODUCTION	80
OUSD STEWARDSHIP RESOURCES	80
KEY MAINTENANCE & STEWARDSHIP ACTIVITIES	81
STEWARDSHIP STAKEHOLDERS	83
MAINTENANCE & STEWARDSHIP PLAN	84
MAINTENANCE & STEWARDSHIP BUDGET	85
STEWARDSHIP AT A GLANCE	85

## 05.

### Appendices

APPENDIX A: STANDARD DETAILS	87
APPENDIX B: TREE LIST	139
APPENDIX C: PLANT LIST	148
APPENDIX D: MAINTENANCE & STEWARDSHIP RESOURCES	156
APPENDIX E: LIVING SCHOOLYARDS: THE WHY	161
APPENDIX F: INDEX	162
APPENDIX G: PHOTO CREDITS	166



# Introduction

INTENT OF GUIDELINES

LIVING SCHOOLYARDS DEFINITION  
AND GOALS



## 00. INTRODUCTION

### Intent of Guidelines

These Guidelines were developed with a Steering Committee comprised of key OUSD staff from many departments, sites and non-profit partners and are intended to be used by OUSD staff, OUSD partners, landscape architects, contractors, students, parents, and community members who are working together to create schoolyards that reflect the shared vision described in the Board Policy on Living Schoolyards.

These Guidelines outline the design principles, components, materials, and processes needed to plan, implement, and manage outdoor play and learning environments that foster climate resiliency, community cohesion, health, and nature connection.

More specifically, these Guidelines intend to:

- **Provide a common set of considerations** and parameters for planning, designing, constructing, and maintaining living schoolyards.
- **Align the many OUSD departments** and stakeholders for building, using, and maintaining living schoolyards.
- **Provide OUSD approved technical design details** of living schoolyard components and materials that meet applicable safety and building codes.
- **Increase efficiency of the process** for the design and construction of living schoolyards. Increase accessibility of living schoolyards and ensure compliance with the Americans with Disabilities Act (ADA).



Students working together at Hoover Elementary School, OUSD.



Garden education board at Peralta Elementary School, OUSD.

- **Incorporate innovation and long-term sustainability** into the planning and design of living schoolyards.
- **Support OUSD's Core Values** through the design and implementation of living schoolyards: Students First; Equity; Excellence; Integrity; Cultural Responsiveness; and Joy.
- **Meet students' developmental needs**, from pre-kindergarten through high school, when designing and maintaining living schoolyards by considering their distinct physical, cognitive, social, and emotional needs.

These Guidelines are to be used in conjunction with existing applicable OUSD policies and regulations. Over time, the Guidelines will be updated to reflect current best practices and new policies. A detailed list of the existing codes, regulations, policies, and standards refer to [Applicable Codes and Policies](#) section on page 23.

Information presented in this document is current as of November 2022. After this date the information, references and/or resources contained within this document may be updated or revised.

This document includes photo examples of how successful living schoolyard projects have served to provide many benefits to students, helping to create schoolyards that benefit the whole child with a comfortable, rejuvenating, and fun environment. These examples come from OUSD schools and beyond as the district strives to share and standardize its best practices for creating living schoolyards.



Living ecosystems provide opportunities for educational engagement, Sankofa United, OUSD



Integrated art and living plants elevate schoolyards and signal to children that they are worthy, Melrose Leadership Academy, OUSD



Sensory plants at Sankofa United Elementary School, OUSD.

## Living Schoolyards Definition and Goals

OUSD Board Policy on Living Schoolyards (BP 7110.1) defines living schoolyards as:

- rich outdoor environments that strengthen local ecological systems,
- provide hands-on learning resources, and
- foster a wide range of play and social opportunities while enhancing health and well-being.

These living schoolyards include trees, gardens, and spaces designed by and for students and the surrounding community.

Through this Board Policy on Living Schoolyards (BP 7110.1) and related policies and administrative regulations, the Board seeks to ensure that OUSD's school grounds support and strengthen the District's commitment to children's well-being, environmental resilience, community engagement, and equity. This vision is supported by the following goals:

- 1.1. Create Outdoor Environments Optimized for 21st Century Education.** OUSD living schoolyards will provide hands-on learning environments for students of all ages, to support standards-based curricula, as well as development of physical and social skills that prepare students for 21st century life and careers.
- 1.2. Increase Children's Joy.** OUSD living schoolyards will foster children's happiness by providing nurturing, engaging, and comfortable spaces where children can experience joy, curiosity, wonder and adventure, build friendships, and feel cared for.
- 1.3. Improve Students' Health and Wellness.** OUSD living schoolyards will promote health and well-being by increasing physical activity, deepening understanding of nutrition, fostering

social-emotional and mental health, and optimizing environmental health through grounds design and management.

- 1.4. Create Vibrant Play and Social Environments.** OUSD living schoolyards will provide engaging, adventurous, and challenging play and recreational opportunities for youth, as well as spaces for small and large group gatherings to support students' social development.
- 1.5. Increase Access to Park Space.** OUSD living schoolyards will support the District's vision of community schools by exploring the potential for public access after-hours and on weekends.
- 1.6. Strengthen Community Engagement.** OUSD living schoolyards will be designed and developed with meaningful participation and collaboration from students, families, school staff, and neighbors of each school.
- 1.7. Prioritize Equity.** The living schoolyard initiative shall prioritize schools and neighborhoods with the highest need to advance equity.
- 1.8. Strengthen OUSD's Environmental Resilience.** OUSD living schoolyards will contribute to the ecological health of their neighborhoods by planting shade trees to improve climate resilience and air quality, capturing, infiltrating, and treating stormwater on site, and creating wildlife habitat by using native plants.

The successful implementation and maintenance of Living Schoolyards across the District relies on close collaboration between OUSD departments, school communities, non-profit partners, and funders. Supporters can help the District with fundraising, advocacy, design, construction, long-term stewardship and maintenance, and curriculum integration. These Guidelines are one of the tools to ensure that these partnerships happen effectively to the benefit of students and community.

## **Design Principles**

**DEVELOP OUTDOOR ENVIRONMENTS  
THAT SUPPORT LEARNING**

**CREATE LANDSCAPES FOR  
CHILD DEVELOPMENT**

**DESIGN FOR EQUITY**

**STRENGTHEN ENVIRONMENTAL  
RESILIENCE**

**BUILD EXISTING ASSETS**

**CONSIDER MAINTENANCE**

The right half of the page features a solid teal background. Overlaid on this background is a faint, white line-art illustration of a leafy branch, extending from the bottom left towards the top right. In the lower right corner, the number '01' is displayed in a large, bold, white sans-serif font.

**01**



# 01. DESIGN PRINCIPLES

The principles below support the Board Policy on Living Schoolyards (BP-7110.1), Board Policy on Wellness (BP-5030), Board Policy on Climate Change Literacy (BP-6142.5), and other OUSD applicable policies, and important objectives created during the process of developing these design Guidelines.

## 1. DEVELOP OUTDOOR ENVIRONMENTS THAT SUPPORT LEARNING

OUSD living schoolyards should be vibrant places where teachers can easily immerse students in curriculum outdoors for more diverse learning opportunities that support different learning modalities. When planning a new space these Principles will be helpful in creating landscapes that support teachers in providing meaningful outdoor learning experiences.

- Develop outdoor environments with one of five distinct learning uses in mind:
  - an **extension of the indoor classroom** to be used solely by that teacher and students;
  - a space that is dedicated and developed to a **specific learning opportunity** such as a garden, an outdoor art space, or outdoor STEM space;
  - an **environmental landscape** that supports curriculum and can be a place for informal daily exploration and play such as a forest, pond, geology garden, and/or pollinator garden;



Outdoor classroom at The Center, OUSD.



Outdoor classroom at Hoover Elementary School, OUSD.

- a flexible and comfortable space that can support a large school gathering which acts as the **school commons** and provides a sense of place; and
  - a flexible space with infrastructure for **seasonal learning opportunities** such as a coop for visiting chicks in Spring or a place for scarecrow making and strawbales in the Fall.
- Provide a gathering space with seating, tables, or counter space that can accommodate an entire class at each learning space. The seating can be secondary or informal seating which are objects that do not read as formal benches such as boulders or logs.
  - Include break-out spaces nearby that allow students to gather in small groups to do their work after meeting as one large group.
  - Provide teaching elements as needed for the space such as a counter and nearby lockable storage that can easily house the learning elements needed for the particular space from paint brushes to microscopes.
  - Incorporate and enhance existing outdoor opportunities throughout the yard when possible, such as in a grove of mature trees, a fenced off stormwater retention area at the edge of the schoolyard, or some boulders.
  - Consider the curriculum opportunities when selecting materials to create an outdoor learning environment.



Outdoor learning at Hoover Elementary School, OUSD.

## 2. CREATE LANDSCAPES FOR CHILD DEVELOPMENT

OUSD living schoolyards are the daily outdoor spaces for OUSD students and should support the development of the whole child—cognitive, physical, social, emotional—for each student at a school. When designing a new space these Principles will be helpful in creating landscapes that support the range of students in the yard to ensure that each child has meaningful time to explore the outdoors and their interests during their free time.

- Consider the age group of the school and the specific needs of that group from Early Childhood, Middle Childhood, and Youth when designing at a site.
- Provide opportunities that support each child’s intrinsic interests in order that they may get into a state of flow during their free time / recess. That may include expanding their gross motor skills in ball play, testing out their creative processes and fine motor skills in fairy house building, needing time for quiet contemplation or other play experiences.
- Integrate opportunities to explore the senses throughout each schoolyard.

## CHILD DEVELOPMENT PHASES

<b>EARLY CHILDHOOD</b> Ages 2+/- to 8 years +/-	<b>MIDDLE CHILDHOOD</b> Ages 6 +/- to 12 +/-	<b>YOUTH</b> Ages 10 +/- to 18 +/-
<p><b>Physical development</b></p> <ul style="list-style-type: none"> <li>Rapid gross motor development</li> <li>Large muscles develop before small muscles</li> <li>Cognitive functioning</li> <li>Children think literally</li> <li>Egocentrism</li> </ul> <p><b>Social emotional development</b></p> <ul style="list-style-type: none"> <li>Developing sense of self</li> <li>Noticing differences among other people &amp; themselves</li> </ul> <p><b>Developmental needs</b></p> <ul style="list-style-type: none"> <li>Environment that encourages exploration &amp; varied challenges</li> <li>Parallel play, places to interact, &amp; places to be alone</li> <li>Imaginary play</li> <li>Creative constructive play</li> <li>Outdoor learning spaces</li> </ul>	<p><b>Physical development</b></p> <ul style="list-style-type: none"> <li>Steady development throughout this period</li> <li>Can grow to be 90% of adult size</li> </ul> <p><b>Cognitive development</b></p> <ul style="list-style-type: none"> <li>Logical thought and reasoning limited to real objects</li> <li>Understands causes &amp; effect</li> <li>Social emotional development</li> <li>Building relationships with peers and adults beyond family</li> <li>Sense of identity - competence, independence &amp; self-awareness</li> <li>Self-esteem is built by comparison to others</li> </ul> <p><b>Developmental needs</b></p> <ul style="list-style-type: none"> <li>Environment that encourages varied challenges</li> <li>Environment that allows children of different aptitudes to shine</li> <li>Places to interact &amp; be alone</li> <li>Opportunities for creative constructive play &amp; experiment</li> <li>Outdoor learning spaces</li> </ul>	<p><b>Physical development</b></p> <ul style="list-style-type: none"> <li>Experience growth spurt</li> <li>Enter puberty</li> <li>Cognitive development</li> <li>Increasing capability for social conscience &amp; abstract thought</li> <li>Take an increased responsibility &amp; independence</li> <li>Social emotional development</li> <li>Increased interest in peer relationships</li> <li>Emerging sense of self / want to blend in</li> <li>Develop romantic feelings</li> </ul> <p><b>Developmental needs</b></p> <ul style="list-style-type: none"> <li>Outdoor spaces that support varied academic &amp; social opportunities</li> <li>Spaces to hang out / seen but not heard by adults</li> </ul>

Children develop using their senses—hearing, sight, taste, smell, tactile, body awareness (proprioceptive), and balance (vestibular). Each child seeks different inputs to balance their sensory systems.

- Develop each site to be as safe as necessary, not as safe as possible to support sensory development, appropriate graduated challenges, and beneficial risk opportunities that nurture whole development of every child.
- Create opportunities for each child to lead where they excel and follow others where they want to learn by providing different play program options.
- Integrate social emotional infrastructure as necessary for the age group such as a play element that encourages collaboration, a buddy bench, and peace path to support healthy social development individually and as a group.

### 3. DESIGN FOR EQUITY

OUSD living schoolyards are an opportunity to design for equity by considering many intersectional issues of environmental justice and child development, including: open space access; climate resiliency; air quality; accessibility, learning differences, and native ecologies. When designing OUSD living schoolyards the following Principles will help address equity.

- Design each living schoolyard to be able to function as a park for the community during non-school hours.
- Design for climate resilience as sited in 4. Strengthen Environmental Resilience.
- Use TPL's Schools & Disadvantaged Communities map to ensure that all school sites throughout OUSD have equitable environments



Student at Hoover Elementary School Garden, OUSD.



Sensory plants at Markham Elementary School, OUSD.



Safe place to look for friends.

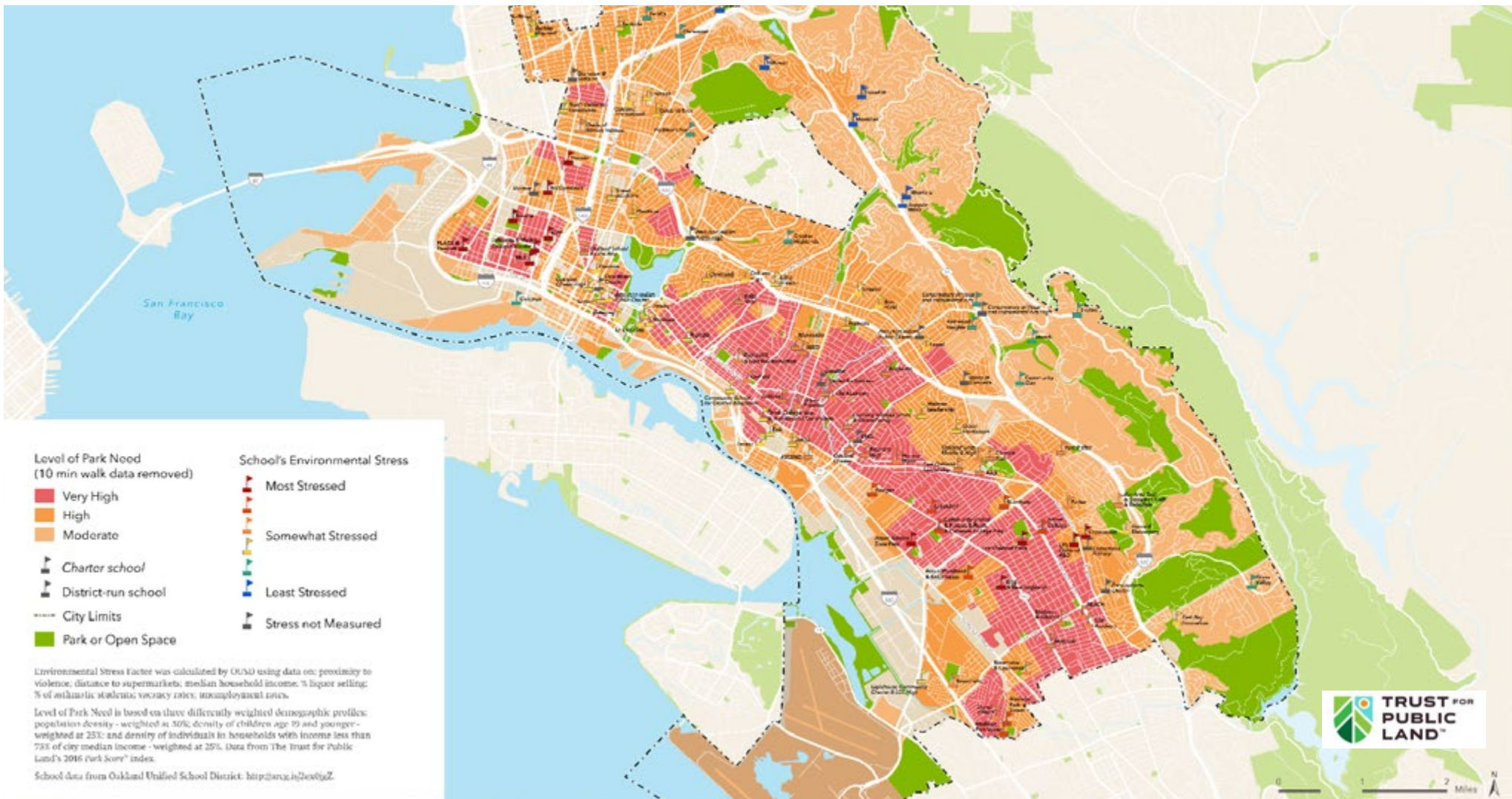

## EXISTING SCHOOLS, ENVIRONMENTAL STRESS & NEED

on site, i.e. clean air and comfortable seasonal spaces.

- Design each site to integrate play elements for inclusive play and accessibility.
- Design each site to address learning differences as defined in 1. Develop Outdoor Environments that Support Learning and 2. Create Landscapes for Child Development.
- Integrate the native ecologies at each site, from grasslands to Oak woodlands, to provide each site with a distinct sense of place and to contribute to the overall ecology within Oakland.

#### 4. STRENGTHEN ENVIRONMENTAL RESILIENCE

The continued design and evolution of OUSD living schoolyards can substantially strengthen OUSD’s environmental resilience potential:

1. by considering all the schoolgrounds as one mosaic; and
2. by making improvements at each school site by using low tech and smart planning that maximizes shade, increases ground surface permeability, and considers energy conservation.

When adding improvements to a site consider the following Principles to strengthen environmental resilience on the site.

- Select and site the appropriate trees for climate change adaptability, habitat, efficiency of stormwater management, air buffering, and seasonal shade. Trees are a long-term, high-return investment in climate resilience.
- When selecting tree species consider how they contribute to the overall habitat mosaic of the OUSD grounds throughout the City of Oakland.
- Develop spaces with more permeable ground surfaces which



Forest planted over 50 years ago, Washington Elementary School, BUSD.



Miyawaki forest planted in 2021, Martin Luther King Jr. Middle School, BUSD.



Stormwater capture at Glenview Elementary School, OUSD.



JTA representing Warriors Community Foundation at Markham Elementary School, OUSD.



Community workday planting trees at Melrose Leadership Academy, OUSD.



Gate designed by student & built by local artist at Peralta Elementary School, OUSD.

will provide climate comfort and function from reducing the ambient air temperature to providing water infiltration on site.

- Consider integrating stormwater best practices into the site as they relate to the overall site and its place in the watershed - from Temescal Creek to Sausal Creek to the SF Bay.
- Consider how these elements may support different forms of play and learning with as described in 1. Develop Outdoor Environments that Support Learning and 2. Create Landscapes for Child Development when integrating them into a site.
- Strengthen climate resilience by considering all improvements, large and small, in relation to the site overall, its master plan, OUSD's sites, and how this improvement builds on the whole system.

## 5. BUILD ON EXISTING ASSETS

OUSD living schoolyards build on the key existing assets of each school - the site's ecological setting and unique characteristics and strengths of the school community and neighborhood. When developing a site consider the following Design Principles.

- Connect to the school's learning goals and vision through elements in the garden, natural exploration areas, art, seating and gathering spaces while building on ecological and cultural assets.
- Expand natural areas or features on or adjacent to the site into nature exploration, learning, or habitat areas.
- Study each school to incorporate the site's water and drainage patterns into the local watershed.
- Engage and include the school and local community, including artists and craftspeople, in planning and design process.
- Integrate community build projects that are appropriate to the community's cultural resources and work with the community to define how they can provide on-going stewardship for the site after construction.

## 6. CONSIDER MAINTENANCE

Maintenance and management considerations are an essential aspect of successful living schoolyard design and planning. When developing a design for living schoolyard follow the Principles below.

Balance the need to foster children’s development, outdoor curriculum, and climate resiliency, with an understanding of the method that supports OUSD’s Buildings and Grounds operating budget and staff capacity when designing new spaces. This may include removing underused lawns at school entries and selecting plants that are more beneficial for children, climate-resilient, and less maintenance than lawns.

Work with OUSD Facilities, Buildings and Grounds, Health and Wellness/ Education and Community Programming Team @ The Center, and school site staff to ensure they are trained to manage the proposed elements related to their departmental responsibilities and expertise. Include the cost of this training in the project budget.

Work with all parties (OUSD Facilities, Buildings and Grounds, Health and Wellness/Education and Community Programming Team @ The Center, on site garden teachers, any involved community organizations, and community stewardship representatives) to ensure the proposed design and future maintenance is achievable early in the design process. Prior to the final design and construction, clearly delineate all the areas of responsibility and associated roles, and ensure these are transferred to the site’s Maintenance Plan and Maintenance Contract.



Caring for plants at Hoover Elementary School, OUSD.



# Design Components

GENERAL AREAS IN A SCHOOLYARD

APPLICABLE CODES & POLICIES

COMPONENTS & MATERIALS

SITE GRADING

PAVING AND SURFACING

RESILIENT PAVING

SITE FURNISHINGS

FENCING

PLAY EQUIPMENT

LANDSCAPING

SIGNAGE



02

## 02. DESIGN COMPONENTS

### 1. GENERAL AREAS IN A SCHOOLYARD

#### Ball and Active Play Spaces

These spaces are primarily designed for ball court and turf sports play with striping and permanent sports equipment such as basketball hoops that can be used for teacher-directed activities for physical education as well as child-directed activities at recess. Located at the edge of these areas are a play structure or series of individual play elements that are primarily designed to encourage gross motor skill, proprioceptive, and vestibular development activities such as climbing, balancing, jumping, swinging, and sliding.

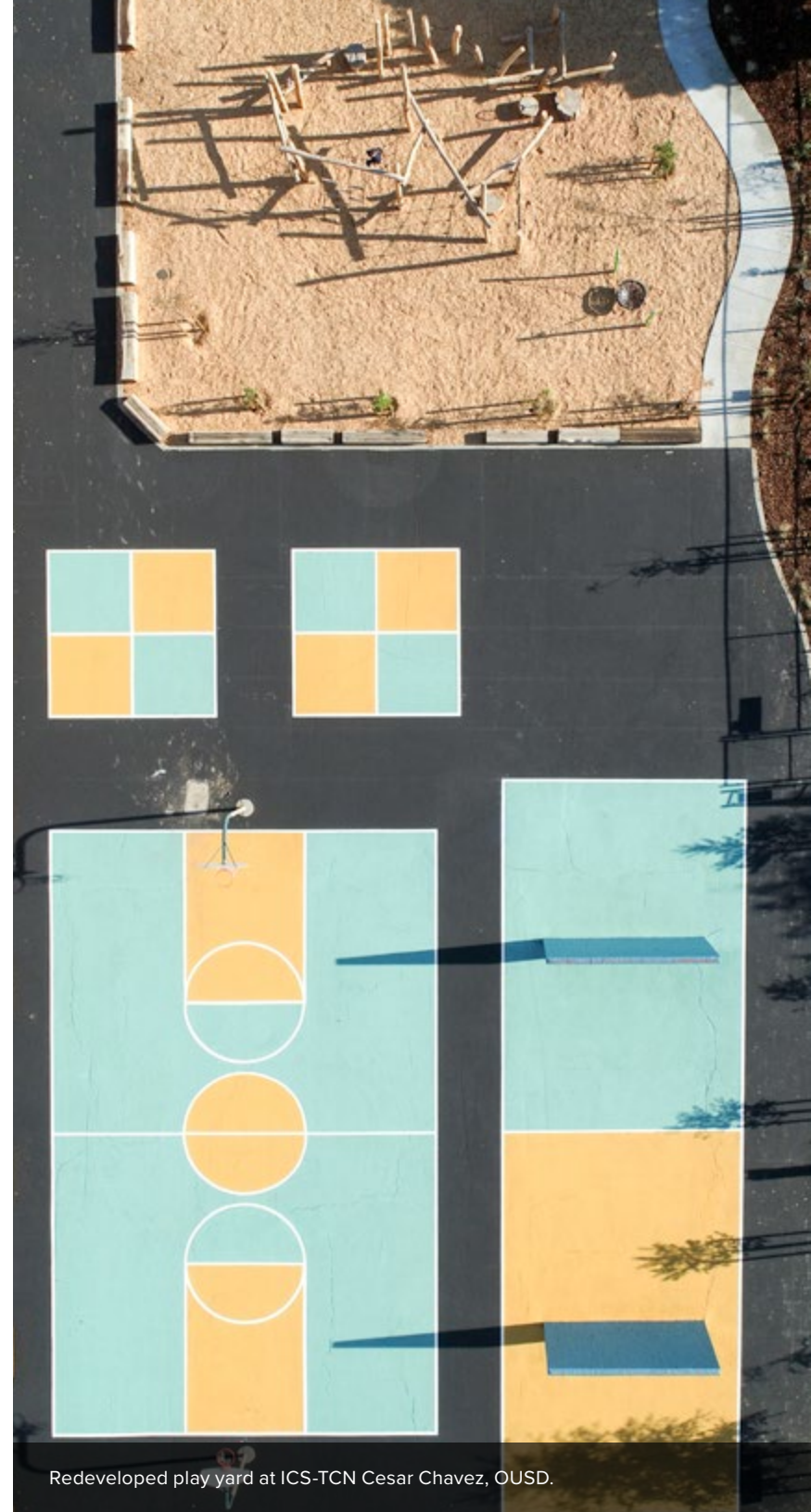

Redeveloped play yard at ICS-TCN Cesar Chavez, OUSD.



### **Nature Exploration Areas**

The location of these spaces may be dependent on the existing natural resources on or adjacent to a school site such as a forest, creek, or grassland. The purpose of this space is four-fold:

- a.** to provide the children with a natural area to explore and immerse themselves in during recess;
- b.** to create a space with ecological processes and natural materials that support science and history curricula at the school;
- c.** to create climate resilient spaces with native and/or drought tolerant plants and shade trees that create habitat and are environmentally with permeable ground surfaces; and
- d.** to offer a unique sense of place tied to the indigenous landscape. Nature Exploration Areas offer children a place to develop their gross motor, social, and cognitive skills while getting into a state of flow on their own or in a group through imaginative play, creative constructive play, and social play. These spaces also offer the unique opportunity of helping children understand and fall in love with nature.

## Gathering Spaces

A school is a composite of communities; the entire student body is a community; each classroom is a community; the staff is a community; and families are the extended community. When communities can easily and physically gather for daily activities, weekly events, and special events, they can form a stronger bond. Gathering spaces may range from an outdoor amphitheater to a cluster of tables or benches conducive to socializing. These spaces may be large or small depending on the need of the school and amount of space available. If sited properly, these spaces will be cherished and used throughout the day, week, and year by all the groups within the school community.



Parents hang out at pick-up, Sequoia Elementary School, OUSD.



Community gathers for event, Peralta Elementary School, OUSD.

## Outdoor Learning Environments

Outdoor learning environment spaces come in three distinct forms:

- a. room extensions or an extended classroom space adjoining an interior classroom purposely designed for one-class use for large and/or messy outdoor projects and classwork;
- b. a specific outdoor classroom such as a garden (most common in OUSD), outdoor kitchen, or an outdoor art space; and
- c. an immersive natural landscape that can be used for mini-weekly field trips as well as a Nature Exploration Area.

These three forms of outdoor classrooms make the schoolyard a place for learning as well as play and provide opportunities for enriched learning from boulders tied to science curriculum to the understanding of stormwater processes. The success of these spaces is “measured” by the frequency of use and depth of learning opportunities. The design of the outdoor learning environment can support educators by developing a layout that works for the program; and siting the gathering space of the classroom adjacent to the learning opportunity.



Outdoor classroom at creek, John Muir, BUSD.



Students in Hoover School Garden the day before lockdown—March 13, 2020.



Outdoor classroom and garden, Lockwood STEAM Academy Elementary School, OUSD.

## Pathways

Pathways simultaneously help to separate areas and act as connectors in schoolyards. They also provide a boundary to areas that should not be entered and can be designed to function as features for informal play. Pathways are essential in planning, and their materiality and layout can foster creative and social play. Paths, tracks, and trails can diversify the play and learning environment. An accessible route should be planned early with consideration of potential future additions for seamless integration to avoid ramps, which divide spaces, where possible.



Path in Nature Exploration Area at Markham Elementary School, OUSD.

## 2. APPLICABLE CODES AND POLICIES OF LIVING SCHOOLYARDS

At the time of publication this is current. Do research before starting to be up to date. There are many codes and regulations that shape the landscape, the primary ones include:

### a. OUSD policies and standards

- Board Policy on **Living Schoolyards** (BP 7110.1)
- Board Policy on **Use of School Facilities** (BT 1330)
- Board Policy on **Vegetation** (BP 3285) Note: to the extent that BP 7110.1 conflicts with BP 3285, BP 7110.1 prevails.
- Board Policy on **Environmental and Water Conservation** (BP 3511)
- Board Policy on **Integrated Pest Management** (BP 3511.2)
- Board Policy on **Wellness** (BP 5030)
- Board Policy on **Environmental and Climate Change Literacy** (BP 6142.5)
- Board Policy on **Facilities Master Plan** (BP 7110)
- Board Policy on **Community Engagement for Facilities Projects** (BP 7155)
- OUSD **Material Standards**
- OUSD **Climate Emergency Action Resolution**
- OUSD School Gardens Toolkit

### b. Federal, State, and County Codes

- The **Americans with Disabilities Act** (ADA)
- **ASTM / CPSC** for play equipment and play surfaces
- **California Building Code** (CBC) and **CalGreen**
- **California Plumbing Code** (CPC)
- **California Water Board**
- **California Retail Food Code** (CalCode)
- **Model Water Efficiency Landscape Ordinance** (MWELO)
- **State Licensing** (Pre-K)

### c. Benchmarks, Certifications, and Awards

- **Collaborative for High Performance Standards** (CHPS)
- **LEED** and **SITES**
- **ReScape / Bay-Friendly**
- **Green Ribbon Schools**

### 3. COMPONENTS AND MATERIALS

The section below covers all materials and elements in a living schoolyard that are defined in these Guidelines and relate to the 2021 OUSD Materials Standards sections as shown outlined in the table below:

No.	Section Title	No.	Subsection Title		
<b>2300</b>	<b>Site Grading</b>	1	<b>ADA and Universal Accessibility</b>		
		2	<b>Stormwater</b>		
		3	<b>Varied Topography</b>		
<b>2730</b>	<b>Paving + Surfacing</b> <i>for all areas except at play equipment</i>	1	<b>Standard Surfacing (non-ball play areas)</b>		
		1.1	Concrete Paving		
		1.2	Asphalt / Asphalt Concrete (AC) Paving		
		1.3	Unit Pavers		
		1.4	GravelPave		
		1.5	Decomposed Granite (DG)		
		1.6	ParkTread		
		1.7	Engineered Wood Fiber (EWF)		
		1.8	Wood Mulch		
		2	<b>Ball Play Surfacing</b>		
		2.1	AC Paving		
		2.2	Living Turf		
		2.3	Artificial Turf		
		<b>2740</b>	<b>Resilient Paving</b>	1	<b>Rubber Tiles</b>
				2	<b>Poured-in-Place Rubber (PIP)</b>
				3	<b>Engineered Cork Surfacing (ECS)</b>
				4	<b>Artificial Turf with safety surfacing</b>
				5	<b>Engineered wood fiber (EWF)</b>
<b>2800</b>	<b>Site Furnishings</b>	1	<b>Tables and Counters</b>		
		2	<b>Seating</b>		
		3	<b>Waste Stream bins</b>		
		4	<b>Planters</b>		
		5	<b>Nature Exploration Elements</b>		
		6	<b>Storage</b>		
		7	<b>Water and Electrical Access</b>		
<b>2831</b>	<b>Fencing</b>				
<b>2882</b>	<b>Play Equipment</b>	1	<b>Selecting Play Equipment</b>		
		2	<b>Loose Parts Play</b>		
<b>2900</b>	<b>Landscaping</b>	1	<b>Trees</b>		
		2	<b>Plants</b>		
		3	<b>Irrigation</b>		
<b>10400</b>	<b>Signage</b>				



Each material or element typically includes:

- a. Considerations.** This subsection outlines the goals, objectives, and benefits of that material. It also provides direction on layout and material choices, and maintenance considerations when applicable to the subject.
- b. Reference Details.** The technical design details that are directly related to the material are listed in this subsection. All reference details are located in [Appendix A: Standard details](#).
- c. Codes and Benchmarks.** This last subsection lists the key applicable codes that relate to the material and may require changes to the existing schoolgrounds to be compliant.

Currently many of OUSD's schoolyards have a significant amount of asphalt paving. Some asphalt will need to be removed to create a living schoolyard that infiltrates stormwater, reduces temperatures, creates an environment to grow healthy trees, and provides meaningful learning and play spaces that enhance student health and well-being. Asphalt removal is also necessary to meet OUSD's new policies, CBC/CalGreen, and CHPS (per OUSD Climate Emergency Action Resolution).



Students at Washington Elementary School, where 1/3 of the yard is asphalt, 1/3 wood mulch and 1/3 turf, BUSD. Lisa Howard, Bay Tree Design

## 2300 Site Grading

Site grading, when done thoughtfully, can provide seamless ADA and universal access, integrated stormwater elements for learning and ecological function, and play and learning opportunities with varied topography.

### 1. ADA and universal accessibility

An accessible route is a network of pathways, ramps (if only option), and transfer systems that provide access to all parts of the schoolyard.

#### a. Considerations

- Design all primary pathways with accessibility for all users in mind.
  - Plan for pathways that lead to, intersect, or run adjacent to all schoolyard settings, elements, and destinations so that anyone using a wheelchair or other mobility device can always be included in play and learning and have options for appropriate and graduated challenges.
  - Provide a variety of path choices to enhance variations for play and exploration and include seating and accessible features along the paths.
  - Develop path systems as a circuit with no dead ends.
  - Build accessible pathways as the main path system that may serve multiple functions to further the experience of inclusion for everyone.
- Limit grades on accessible routes to less than 5% where possible to avoid ramps which break up the “flow” of a space.
  - Design main path to be wide enough to accommodate all pedestrian traffic and integrate pullouts that simultaneously meet ADA but can serve as other functions as well.
  - When transfer systems are needed, if possible, integrate them into retaining or seat walls if the dimensions are designed to meet current codes.
  - **Materials:**
    - All ADA pathways shall be constructed with materials that are ADA compliant, uniform, stable, and non-slip surfaces.
    - ADA pathways for emergency egress from the buildings to the safe dispersal area shall be built with ADA compliant materials that do not require frequent maintenance to maintain compliance.
    - ADA pathways to learning and play elements and spaces may be constructed with permeable materials such as GravelPave, ParkTread, decomposed granite (DG), and engineered wood fiber (EWF).
    - All secondary or informal pathways that do not serve as a primary access to any particular play element or learning space but offer alternative routes may be narrow, meander around landscape elements, and made of materials that are not ADA compliant.

2300 Site Grading

- **Maintenance:** When loose materials such as Gravelpave2 or EWF are used the regular maintenance requirements to maintain accessibility will need to be planned with OUSD Buildings and Grounds, and the school site administrators, in the early design phases of the project. Maintenance specific to each detail is included on the detail.

**b. Reference Details**

- 2730.01 Asphalt with Concrete Edge
- 2730.02 Permeable Pavers - Full Filtration
- 2730.03 Gravelpave2
- 2730.04 Decomposed Granite (DG) with stabilizing binder
- 2730.05 ParkTread
- 2730.06 EWF / Mulch
- 2730.07 Loose Surfacing Materials Mitigation
- 2740.01 Engineered Wood Fiber (EWF) with accessible ramp
- 2740.02 Corkeen, a form of Engineered Cork Surfacing

**c. Codes and Benchmarks**

- ADA / California Building Code (CBC) - Accessibility Codes

**2. Stormwater**

Capturing, slowing down, and cleaning stormwater runoff is required by code, adds to the climate resilience response for the site, and is an educational opportunity.

**a. Considerations**

- Consider the design and placement of the stormwater system and features on a schoolyard in relation to the local watershed, how to



Demonstration cistern used to water garden at Marshall Elementary School, SFUSD.



Dry Creek Bed in play area at Mercy Bush Park, Menlo Park.



Play and paths designed for topography at Manzanita Rec Center, Oakland.

## 2300 Site Grading

integrate into it most effectively, and how to utilize that particular location as a learning opportunity.

- Make the entire system visible and include curriculum features such as truth tubes (as shown in the attached image) and signage for educational purposes.
- Keep stormwater collected from run-off from parking lots and other hazardous areas and materials such as tar-based roofs separate from child accessible areas of the schoolgrounds.
- Make part of the system accessible to children where stormwater is considered clean so that they may interact with it for learning and play purposes.
- If stormwater is collected in a cistern the water is rated non-potable and is identified with signage. If the cistern is less than 360 gallons and the water is used for irrigation than there are no minimum rainwater quality requirements. If storage is greater than 360 gallons and less than 5,000 gallons, then a debris excluder or similar device is required to meet California plumbing codes for non-potable water for irrigation.
- **Layout:**
  - Consider the drainage patterns, site uses, outdoor zones and main circulation routes while designing the stormwater system to address needs of the site.
  - If removing asphalt to install stormwater features some analysis will be required to ensure clean soils and proper drainage due to heavily compacted soils under the asphalt.
  - Locate stormwater capture best management practices (BMPs) - bioretention planters, cisterns, and bioswales - in places that provide maximum capture such as at building downspouts and low points in the schoolgrounds.
  - Locate bioswales and at grade bioretention areas away from active ball play areas.
- Use a fence, change in grade, or other design feature to keep children from entering bioretention planters and swales, that require special soils for performance.
- Add signage in the area that explains the intentions, functions, use, and restrictions to the area for teachers, staff, children and the community.
- **Maintenance:** Cisterns require maintenance every six months (fall and spring) to ensure proper and safe functioning. The responsible party for this maintenance must be identified before a cistern is installed. See Chapter 4: Maintenance and Stewardship for additional information.

#### b. Reference Details

- 2300.01 Bioretention Basin
- 2300.02 Rainwater Cistern
- 2300.03 Dry Creek Bed
- 2730.02 Permeable Pavers / Full Filtration
- 2831.03 Stormwater Fence

#### c. Codes and Benchmarks

- California Water Board SB541
- California Building Code (CBC) and CalGreen w
- California Plumbing Code (CPC)
- Collaborative for High Performance Standards (CHPS)

### 3. Varied topography

Variation in topography is an important learning and play element in schoolyards.

#### a. Considerations

- Integrate amphitheater seating, trails, climbing features, and an embankment slide or other play and/or learning features in the slope.
- Provide vantage points and perspectives of the site and/or adjacent site with the use of slopes and berms. Vantage points are an opportunity for learning and important for development.
- Work with the change in topography to integrate ADA accessible paths.
- Locate a slope or berm where sightlines will not be disrupted for supervision.
- **Layout and Materials:**
  - A good height for an amphitheater, climbing hill, or embankment slide is a minimum of three to four feet.
  - Grading of the slope shall be a maximum 3:1 ratio.
  - Grading at the base of the berm / slope needs to be level with the adjacent grades.
  - Drainage for the slope / berm will need to be integrated into the site.
  - Consider adding signage in the area that explains the purpose and restrictions to the area for teachers, staff, children and the community.
- **Maintenance:** On wet days the slope / berm may be off limits to ease maintenance.



Students preparing tiered planting beds at Bella Vista Elementary School, OUSD.

## 2730 Paving and Surfacing

(for all areas except at play equipment)

Asphalt, rubber tiles, and artificial turf have typically been the primary schoolground surfaces for decades. These three materials all significantly increase the ambient air temperatures on a schoolyard. Asphalt and rubber tiles are also impermeable. To meet OUSD's new policies, CBC/ CalGreen, and CHPS (per OUSD Climate Emergency Action Resolution), this paving palette will need to incorporate surfaces that provide permeability on a site and lower air temperatures. In addition, crumb rubber fill used in artificial turf

A variety of surfacing within a living schoolyard can provide paving specific to the general area needs, types of pathways, and address climate inequities across the OUSD campuses, specifically urban heat island effects and stormwater resilience. Materials and colors can be specified to meet all the current codes and lower, rather than significantly increase, the ambient temperatures. Pervious paving materials can help address stormwater runoff and different materials can denote distinct areas and experiences within a schoolyard providing stimulants for physical, cognitive, and social development. When designed to the Guidelines, the addition of loose materials should not create maintenance or safety issues.

All materials under 2730 are organized to correspond to the two tables: (1) Standard surfacing and (2) ball play surfacing. Principles and Key OUSD Policies, codes and benchmarks are outlined as one general section that covers all paving in 2730. Guides and Reference Details are outlined further under each specific material which follows the organization of the two tables mentioned above.

### a. Considerations for all paving and surfacing in 2730

- Use the appropriate surfacing for the function of the space.
- Consider striking a balance between hard and soft surfacing as well as pervious and impervious surfaces.
- Plan for stormwater capture when designing large areas of hard surfacing.
- Design all primary pathways with materials that meet ADA as detailed in the site grading.
- Integrate secondary pathways which can provide narrow meandering paths in gardens and Nature Exploration Areas.
- Use permeable paving on walkways and in parking lots to reduce storm water runoff and increase ground percolation.
- Design ball play surfaces with colors and/or materials to create the lowest ambient air temperature possible because these spaces comprise a large portion of the schoolyard. Paving for sports activities can be designed for court and field activities depending on the surface chosen.
- Prioritize permeable and natural paving in gardens and Nature Exploration Areas for climate resiliency, sustainability, sensory stimulus, and sense of place.
- Design to mitigate loose material migration in areas between loose surfacing material and any other surface material.
- **Maintenance** is specific to each material and is included in the details and narrative specific to materials below.

### b. Codes and Benchmarks

- California Building Code (CBC) and CalGreen
- The Americans with Disabilities Act (ADA)
- Collaborative for High Performance Standards (CHPS)
- LEED and SITES
- ReScape / Bay-Friendly

## 1. Standard Surfacing

The options below are for surfacing in general areas throughout the yard that are not intended for ball play or as resilient surfacing. These paving materials are in Table 1: Standard Surfacing.

### 1.1. Concrete Paving

#### a. Considerations

- Consider that concrete is ADA accessible, can be permeable, and can be designed for vehicular access. It is the most stable material for ADA accessibility.
- Use integral concrete colors that meet CHPS SRI values of at least 0.29 to reduce ambient heat. Shading of paved areas would further lower ambient air temperatures.
- Integrate learning into paving patterns
- Embed slip resistant elements.
- Consider using permeable concrete, when installing new concrete paving.
- Do not overspecify for strength, and consider measuring strength conformity at 56 days rather than the conventional 28 days.
- Specify reasonably-sourced concrete and reinforcement. Permit the use of recycled aggregates and the use of admixtures.

**Maintenance:** Repair concrete paving when it lifts and cracks, in approximately 25 years. Maintain permeable concrete paving, to maintain permeable properties.



TABLE 1: KEY

<sup>1</sup> Frequency is dependent of traffic, weather, and other variables. These windows are approximate.

<sup>2</sup> Depends on manufacturer

<sup>3</sup> Can be permeable with maintenance

<sup>4</sup> Semi-permeable

<sup>5</sup> Proper depth of material must be maintained for relevant play structure heights

*All data in table is based on the assumptions that surfacing material is installed and maintained per landscape architect / civil engineer / manufacturer / and/or OUSD Facilities recommendations.*



TABLE 1: GENERAL PAVING AND GROUND SURFACINGS

MATERIAL	CODES		COST CONSIDERATIONS											SUSTAINABILITY					CHILDREN'S WELL-BEING								
	Wheel Chair Access	Vehicular Access	Install Costs	Who Can Install			Schoolyear Maintenance Requirements			Summer Repair			Typical Warranty	Base Material	Life cycle	Urban Heat Island Effect		Water			Potential Hazards						
				Contractor	Facilities	Educator / Community	Sweeping / blowing	Raking / Grooming	Frequency	What to Repair	Contractor	Facilities	Educator / Community			Frequency¹	Dependent on Proper Maintenance / Design	Temperatures (varies based on SRI)	SRI (> 0.29) color options	Water Use	Stormwater permeability	Possible Pollutants	Heat-Related Illness, Burns	Hard Surface	Potential to be slippery	Splinters	
Asphalt	Y	Y	L	X			X		L	Patching, reslurry, and restripe	X	X		10 yrs	N/A	Petroleum	Recyclable; landfill	Significantly increases heat	Y	N/A	D³	Y	X	X			
Concrete	Y	Y	H	X			X		L	Pressure wash or steam permeable paving	X	X		Every year if permeable; as needed for non-permeable	N/A	Crushed rock	Recyclable; landfill	Increases heat	Y	N/A	D³	N		X			
Unit Pavers	Y	Y	H	X			X		L	Pressure wash or steam permeable paving	X	X		Every year if permeable; as needed for non-permeable	D²	Crushed rock	Reusable	Increases heat	Y	N/A	D³	N		X			
GravelPave	Y	Y	L	X				X	L	Top off	X	X		Top off every 7-10 yrs	5 yrs	Gravel and recycled plastic	Reusable; landfill	Slightly increases heat	Y	N/A	Y	N		X			
ParkTread	Y	Y	L	X			X		VL	Patching	X	X		5-10 yrs	15-25+ yrs	Crushed rock	Recyclable; landfill	Slightly increases heat	N/A	N/A	D⁴	N		X			
Decomposed Granite (DG)	Y	Y	L	X			X		VL	Patching	X	X		5-10 yrs	N/A	Crushed rock	Recyclable; landfill	Slightly increases heat	N/A	N/A	D⁴	N		X	X		
Engineered wood fiber (EWF)	Y	N	L	X	X			X	L	Top off	X	X		Every 1-3 yrs	15+ yrs	Wood	Bio-degradable	Moderates temperatures	N/A	N/A	Y	N				X	
Wood chips	N	N	VL	X	X	X	X	X	M	Top off	X	X	X	Every 1-3 yrs	N/A	Wood	Bio-degradable	Moderates temperatures	N/A	N/A	Y	N					X

## 1.2 Asphalt / Asphalt Concrete (AC) Paving

### a. Considerations

- Consider that AC paving is currently the most common paving in OUSD schoolyards. Replace AC paving with new paving when new paving is installed, where possible. Where patching is required, in ball play areas and in parking lots, new AC paving may be installed.
- Consider that AC paving is ADA accessible, can be permeable, can be designed for vehicular access, and can be painted to address ambient air temperature. It is less stable than concrete and does not hold consistent slopes well over time which makes it difficult to maintain ADA compliance.
- Paint AC paving with colors to reduce the ambient heat and solar exposure, to increase the solar reflectance index (SRI) value and meet the CHPS SRI values. Shading of paved areas further lowers ambient air temperatures.
- Creatively design slip-resistant striping in AC paving areas to integrate curriculum and school identity with the ball play needs.
- Install concrete curb edging between AC paving and any other surfacing in high traffic areas and at stormwater BMP edges to protect the existing asphalt layers.
- Consider permeable paving if not in an active ball play area, if installing new AC paving.
- Consider that AC paving needs slurry coats and patching every few years depending on use.
- **Maintenance:** Maintain permeable AC paving occasionally to retain permeable properties of the material. Maintain selected colors and patterns, when AC paving is re-slurried and re-striped, to keep the SRI values and embedded learning and play elements.

### b. Reference Details

- 2730.01 Asphalt with Concrete Edge



AC paving with painted colors at Markham Elementary School, OUSD.



Permeable pavers, La Entrada Middle School, Las Lomitas Elementary School District.

### 1.3 Unit Pavers

#### a. Considerations

- Consider that unit pavers are ADA accessible, can be permeable, and can be designed for vehicular access.
- Use new pavers that meet CHPS SRI values to reduce ambient heat. Shading of paved areas would further lower ambient air temperatures.
- Use pavers in areas to denote a gathering space, outdoor classroom, or other significant outdoor rooms.
- **Maintenance:** Replace pavers if needed. Otherwise, they require no maintenance.

### 1.4 GravelPave

#### a. Considerations

- Consider that GravelPave is ADA accessible, permeable, and can be designed for vehicular access.
- Select gravel colors that meet CHPS SRI values to reduce ambient heat. Provide shading for gravel areas to further lower ambient air temperatures.
- Consider using GravelPave for areas that are not designed for play and where children will be closely supervised such as in Outdoor Learning Environments.
- **Maintenance:** Rake GravelPave from time to time to maintain the ADA accessibility. This is an easy task that could be folded into the stewardship of the site. Top off gravel approximately every 5 to 10 years depending on intensity of use.

#### b. Reference Details

- 2730.03 Gravelpave2

### 1.5 Decomposed Granite (DG)

#### a. Considerations

- Consider that DG is ADA accessible, inexpensive, natural, lowers temperatures, and is semi-permeable when installed with stabilizers.
- Select new DG fines colors that meet CHPS SRI values to reduce ambient heat. Shading of paved areas would further lower ambient air temperatures. DG can be used in Outdoor Learning Environments, Nature Exploration Areas, and paths throughout the yard.
- Design the layout of the space to contain the semi-loose material. Include a threshold at the paths that connect to fixed paving material. GraniteCrete stabilizer is required. No substitutions are allowed.
- Use planting and grading to minimize the semi-loose material from clogging the storm drain system – nearby catch basins and area drains. This will reduce the chance of fines clogging drainage.
- **Maintenance:** Patch DG every 5 to 10 years to address places of erosion and wear, particularly on ADA accessible paths. The frequency of patching will depend on the intensity of use and weather.

#### b. Reference Details

- 2730.04 Decomposed Granite (DG) with stabilizing binder
- 2730.07 Loose Surfacing Materials Mitigation

### 1.6 ParkTread

#### a. Considerations

- Consider that ParkTread is ADA accessible, inexpensive, highly durable, natural, semi-permeable, and offers a high SRI value
- Consider the use of ParkTread in Outdoor Learning Environments, Nature Exploration Areas, and paths throughout a Living

2730 Paving + Surfacing

Schoolyard.

- Design the layout of the space to contain the semi-loose material. Include a threshold at the paths that connect to fixed paving material. Threshold may be similar to ADA ramp to contain loose material.
- Use planting and grading to minimize the semi-loose material from clogging the storm drain system—nearby catch basins and area drains. This will reduce the chance of fines.
- **Maintenance:** Patch ParkTread every 5 to 10 years to address places of erosion and wear, particularly on ADA access paths. The frequency of patching will depend on the intensity of use and weather.

b. Reference Details

- 2730.05 ParkTread

1.7 Engineered Wood Fiber (EWF)

a. Considerations

- Consider that EWF is ADA accessible, inexpensive, lowers temperatures, is permeable, and provides the best ASTM approved attenuated surfacing for preventing long bone fractures.
- Design the layout of the space to contain the loose material. Include a threshold at the paths where it connects to fixed paving materials.
- Use planting and grading to minimize the wood chips from clogging the storm drain system—nearby catch basins and area drains.
- **Maintenance:** Rake EWF occasionally to meet the ADA. EWF will need to be replenished every few years to maintain the appropriate depth to meet the ADA and/or ASTM F2223-10. Actual



DG in Peralta Elementary School Kindergarten Yard, OUSD.



GravelPave in learning garden at Oxford Elementary School, BUSD.



ParkTread at the Presidio, San Francisco.

2730 Paving + Surfacing

quantities and timing of replacement of EWF will depend on site conditions, use patterns, drainage, and size of space. Design EWF areas to hold a couple inches more than minimum.

**b. Reference Details**

- 2730.06 EWF / Mulch
- 2730.07 Loose Surfacing Materials Mitigation

**1.8 Wood Mulch**

**a. Considerations**

- Consider that mulch is very inexpensive, lowers temperatures, helps soils sequester carbon, prevents soil erosion, is permeable, and provides an attenuated surfacing (that is not ASTM approved but can meet CPSC requirements for a fall surface when provided at the proper depth).
- Consider that aged arbor mulch with a shredded texture is highly recommended.
- Consider that Mulch provides nutrients to the soil and can be locally sourced.
- Consider using Mulch in planting areas, and areas of Outdoor Learning Environments and Nature Exploration Areas that do not need to be ADA accessible.
- Design the layout of the space to contain the loose material. Include a threshold at the paths that connect to fixed paving material.
- Use planting and grading to minimize the wood chips from clogging the storm drain system—nearby catch basins and area drains.
- Consider the source to ensure that it is natural and untreated wood that does not contain contaminants or pathogens.



Mini library and wood mulch, MetWest High School, OUSD.



Instruments, log bench & wood mulch at Markham Elementary School, OUSD.

## 2730 Paving + Surfacing

- **Maintenance:** Replenish mulch every six to 12 months to maintain the appropriate depth. Actual quantities of and timing of replacement will depend on site conditions, use patterns, drainage, and size of space. Responsible party will need to monitor the quantity, delivery days and times, and ensure proper site permission has been gained prior to delivery.

#### b. Reference Details

- 2730.06 EWF / Mulch
- 2730.07 Loose Surfacing Materials Mitigation

## 2. Ball Play Surfacing

The options below are for surfacing in ball play areas in the yard. Some paving materials may also be included above for standard surfacing areas. This section details paving that is appropriate for ball play and how the paving can be developed specifically for ball play. These paving materials are in [Table 2: Ball Play Surfacing](#).

### 2.1 AC Paving

#### a. Considerations

- Consider that AC paving is ADA accessible, can be permeable, can be designed for vehicular access, and can address ambient air temperature. It is less stable than concrete.
- Consider that AC Paving is existing and should primarily be used in active ball play areas designed for court play and some circulation areas.
- Paint colors that meet CHPS SRI values should be used to reduce ambient heat. Shading of paved areas would further lower ambient air temperatures.

- Design slip resistant stripping in these areas to creatively integrate curriculum and school identity with the ball play needs.
- Install concrete curb edging between asphalt paving and other surfacing in high traffic areas and at stormwater BMP edges to protect the existing asphalt layers.
- Consider permeable paving if installing new AC paving that is not in an active ball play area.
- **Maintenance:** Apply slurry coat and patch AC paving every few years, depending on use. Maintain selected colors and pattern when AC paving is re-slurried and re-stripped to keep the SRI values and embedded learning and play elements.

#### b. Reference Details

- 2730.01 Asphalt with Concrete Edge

### 2.2 Living turf

#### a. Considerations

- Consider that living turf is relatively inexpensive to install, lowers temperatures and is permeable, but requires weekly mowing.
- Consider that living turf is useful for field sports.
- If installed, specify a low water use sod or turf.
- If installed, with the EPIC system, the irrigation requires less water and stormwater BMPs can be installed under the turf.
- Include access (103" opening) for an OUSD lawn mower, in the design of the turf space.
- **Maintenance:** Reseed living turf each summer to fill in the wear spots.

TABLE 2: BALL PLAY SURFACINGS

MATERIAL	SPORTS BENEFITS			COST CONSIDERATIONS									SUSTAINABILITY					CHILDREN'S WELL-BEING									
	Potential for Concussion <sup>1</sup>	Play After Rain Event	Play in High Heat	Install Costs	Who Can Install			Schoolyear Maintenance Requiements			Summer Repair			Typical Warranty	Base Material	Life cycle	Urban IHeat Island Effect		Water			Potential Hazards					
					Contractor	Facilities	Educator/Community	Sweeping / blowing	Raking / Grooming	Washing	Mowing & Irrigation	Frequency	What to Repair				Contractor	Facilities	Frequency <sup>8</sup>	Dependent on Proper Maintenance / Design	Temperatures (varies based on SRI)	Solar Reflectance Index (> 0.29) color options	Water Use	Stormwater permeability	Possible Pollutants	Heat-Related Illness, Burns	Chemicals of Concern
Living Turf	L <sup>2</sup>	N <sup>4</sup>	Y	M <sup>6</sup>	X	X				X	H	Patch and/or reseed at high traffic areas, Irrigation repairs	X	X	Every 1 to 3 years	N/A	Plants	Biodegradable	Moderates temperatures	N/A	L - H <sup>9</sup>	Y	Y <sup>10</sup>				X
Artificial turf w/ cork infill	M <sup>3</sup>	Y	M <sup>5</sup>	H	X			X	X <sup>7</sup>		M	Remove and replace turf with Contractor at seams and high traffic areas	X	X	Every 3 to 5 years	Up to 8 to 10 years	Petroleum, Cork	Landfill	Increases heat <sup>5</sup>	N	L	Y	Y				
Artificial turf w/ acrylic-coated sand infill	M <sup>3</sup>	Y	M <sup>5</sup>	H	X			X	X <sup>7</sup>		M	Remove and replace turf with Contractor at seams and high traffic areas	X	X	Every 3 to 5 years	Up to 8 to 10 years	Petroleum, Sand, Acrylic	Landfill	Increases heat <sup>5</sup>	N	L	Y	Y				
Artificial turf w/ crumb rubber infill	M <sup>3</sup>	Y	N <sup>5</sup>	H	X			X	X <sup>7</sup>		M	Remove and replace turf with Contractor at seams and high traffic areas	X	X	Every 3 to 5 years	Up to 8 to 10 years	Petroleum	Landfill	Increases heat <sup>5</sup>	N	L	Y	Y	X	X <sup>11</sup>		

TABLE 2: KEY

- <sup>1</sup> The consequences of concussion in developing brains are more damaging than in the adult brain. 1 in 5 concussions result from a head to surface impact. (Concussion Legacy Foundation, 2015)
- <sup>2</sup> proper maintenance and periodic aeration maintain good fall attenuation.
- <sup>3</sup> Artificial turf systems provide less fall attenuation and result in higher incidence of concussion than natural turf. (Concussion Legacy Foundation, 2015).
- <sup>4</sup> with EPIC system can play after rain event
- <sup>5</sup> Surface temperatures of synthetic turf with crumb rubber fill measured at 40°F+ higher than asphalt and 85°F+ hotter than natural turf. (NYC Dept. of Health and Mental Hygiene, 2008). Cork and acrylic-coated sand infill artificial turf provides some more moderation of heat than crumb rubber.
- <sup>6</sup> Installation cost considers irrigation.
- <sup>7</sup> May need to address vandalism and food mess; wash animal waste buildup; wash regularly for mold
- <sup>8</sup> Frequency is dependent on traffic, weather, and other variables. These windows are approximate.
- <sup>9</sup> Dependent on turf specified; UC Davis Verde Buffalo grass is a low water use option.
- <sup>10</sup> Use of harmful pesticides and herbicides can be mitigated under an Integrated Pest Management program.
- <sup>11</sup> Chemicals of concern found in crumb rubber: known human carcinogens (Benzene, Arsenic, Cadmium, Chromium, VOCs and SVOCs, Crystalline Silica), Reasonably anticipated human carcinogens (Styrene, Polycyclic aromatic hydrocarbons (PAHs)), Neurotoxicants (Lead, Zinc, VOCs and SVOCs), Respiratory irritants (Chromium, VOCs and SVOCs, Crystalline Silica, Particulate matter), Reproductive toxicant (Phthalates), Allergen (Latex).

*All data in table is based on the assumptions that surfacing material is installed and maintained per landscape architect / civil engineer / manufacturer / and/or OUSD Facilities recommendations.*



## 2.3 Artificial turf

### a. Considerations

- Consider that Artificial turf is expensive, increases temperatures more than any other surfacing option, and can be permeable.
- Consider that Artificial turf is useful for field sports on sites that do not have high temperatures. However, this material runs hotter than AC paving and concrete and can significantly contribute to Urban Heat Island effects.
- Consider the potential health risk of using some of these products. Chemicals of concern found in crumb rubber include known human carcinogens, neurotoxins, respiratory irritants, and reproductive toxins. Over time, new information and studies may provide additional health concerns related to these materials.
- Consider that Artificial turf is highly durable and may be the best option for small play fields that get intensive use.
- If installed, it will require irrigation or a hose bib to clean it and cool it.
- If installed, in an area that is currently asphalt, the asphalt should be removed so that the artificial turf can create a permeable field with more fall cushion.
- If installed, select artificial turf with a high warranty, cork or acrylic-coated sand infill, and lighter colors.
- If installed, trees should be planted adjacent to the field on the south, west, and east sides to create shade on the surface.
- **Maintenance:** This material is an outdoor carpet and will require maintenance to address vandalism, wear, and accidents. The material will require repair at the seams and patching every few years and full replacement in seven to ten years.



AC paving and living turf at ICS-TCN Cesar Chavez Campus, OUSD.



Living turf at ICS-TCN Cesar Chavez Campus, OUSD.



Artificial turf at Markham Elementary School, OUSD.

## 2740 Resilient Paving

The purpose of resilient paving is to protect children from serious head or bodily injury when they lift their feet from the ground surface while interacting with play elements such as horizontal ladders or climbing walls. Resilient surfacing must meet the codes of ADA as well as ASTM F2223 at installation and be maintained to meet those codes during its lifetime. The District with a CPSI should establish that the surfacing meets ASTM at install and develop a maintenance routine to ensure that the surfacing continues to meet ASTM. Loose material ground surfaces provide better impact ratings, are permeable, and cost less to install, but require more regular maintenance. Resilient paving such as tiles, turf, or poured-in-place rubber create a significantly higher ambient temperature than natural resilient ground surfaces but require little maintenance. Engineered cork surfacing moderates heat and provide a low-maintenance resilient ground surface.

All materials under 2740 are organized to correspond Table 3: Resilient Paving. Below Principles and Key OUSD Policies, codes and benchmarks are outlined as one general section that covers all paving in 2740. Guides and Reference Details are outlined further under each specific material which follows the organization of the Table 3.

### a. Considerations

- Use an ASTM-approved attenuated fall surface in all designated use zones of ASTM-approved play equipment.
- Use a combination of a fixed resilient paving for the ADA path of travel with EWF in all other use zone areas to lessen maintenance while reducing construction cost, material replacement costs, and providing a safer and more sustainable surfacing material.
- Design the play surfacing so that the resilient paving is not excessive in size in relation to the use zones.
- Integrate tree wells in non-use zone areas of the play surfacing to provide natural shade which is cooler than man-made shade options.
- Choose colors that consider the SRI value to reduce ambient temperatures around play equipment as much as possible.

### c. Codes and Benchmarks

- The Americans with Disabilities Act (ADA)
- ASTM F2223 and F1951
- CPSC - Public Playground Safety Handbook
- Collaborative for High Performance Standards (CHPS)
- LEED and SITES

## 1. Rubber tiles (Tiles)

### a. Considerations

- Consider that tiles are being phased out by most manufacturers and thus have become very expensive to purchase. Tiles increase temperatures and are typically installed on AC paving thus do not provide a permeable surfacing.
- Consider that rubber tiles contain chemicals including known carcinogens, neurotoxins, respiratory irritants, reproductive toxicants, and allergens.
- Consider that color options typically do not meet CHPS SRI values.
- Consider that this surfacing, when OUSD can replace individual tiles on their own and solid color tiles are chosen, is the lowest maintenance play surfacing option from a time and materials basis.
- **Maintenance:** Reglue tiles to maintain flush surface as needed. Replace tiles when resilient surfacing no longer meets ASTM requirements and/or the tile is worn down from use.

## 2. Poured-in-place rubber (PIP)

### a. Considerations

- Consider that PIP is expensive, increases temperatures, and is permeable.
- Consider playful colors that meet CHPS SRI values when installing PIP
- Consider embedding play and learning elements such as math scotch into the design when installing PIP



Rubber tiles at Markham Elementary School, OUSD.



Mosaic Frog and poured-in-place rubber at Markham Elementary School, OUSD.

- Consider adding three-dimensional shapes to the surface that enhance the play environment when installing PIP
- Consider that poured-in-place rubber contains chemicals including known carcinogens, neurotoxins, respiratory irritants, reproductive toxicants, and allergens.
- **Maintenance:** Resurface the topcoat of this surfacing in high traffic areas, such as slide exit zones and under swings, every few years. Seams of the topcoat may also need maintenance. The life of PIP is dependent on use, weather, nearby soils, and maintenance. It will need full replacement in seven to ten years.

### 3. Engineered cork surfacing (ECS)

#### a. Considerations

- Consider that ECS is a relatively new product. It is renewable, natural, permeable, and does not increase ambient temperatures.
- Consider that at the time of this writing, it has been installed all over the City of Philadelphia and in many locations on the East Coast. This is a material to consider with time and/or test in a small space and/or watch how it performs in nearby local schoolgrounds.

#### b. Reference Details

- 2740.02 Corkeen, a form of Engineered Cork Surfacing

### 4. Artificial turf with safety surfacing (Turf)

#### a. Considerations

- Consider that Artificial turf is expensive, increases temperatures more than any other surfacing option, and can be permeable.
- Consider that crumb rubber contains chemicals including known carcinogens, neurotoxins, respiratory irritants, reproductive toxicants, and allergens.
- Consider that using cork or coconut fill lowers the temperature effect and exposure to toxicants. Chemicals of concern found in crumb rubber include the known human carcinogens: Benzene, Arsenic, Cadmium, Chromium, and Crystalline Silica, as well as the reasonably anticipated human carcinogens: Styrene, Polycyclic aromatic hydrocarbons (PAHs); the neurotoxicants Lead and Zinc; the respiratory irritants: Chromium, Crystalline Silica and particulate matter; the reproductive toxicant Phthalates, and the allergen Latex. Crumb rubber also includes VOCs and SVOCs which are known human carcinogens, neurotoxicants and respiratory irritants.
- If installed it will require irrigation or a hose bib to clean it and cool it.
- If installed select artificial turf with a high warranty, cork infill, and lighter colors.
- If installed trees should be planted adjacent to the play area on the south, west, and east sides to create shade on the surface.
- **Maintenance:** This material is an outdoor rug and will maintenance to address vandalism, wear, and accidents. The material will require repair at the seams and patching every few years and full replacement in seven to ten years.

TABLE 3: RESILIENT PAVING

MATERIAL / PRODUCT	CODES		COST CONSIDERATIONS										SUSTAINABILITY					CHILDREN'S WELL-BEING									
	Wheel chair access	Safety surfacing <sup>2</sup>	Install Costs	Who can install		Schoolyear maintenance requirements			Regular summer maint.		Repair			Typical warranty	Base Material	Life cycle	Urban Heat Island		Water			Potential Hazards			Sensory input and inclusive play	Learning and Play value	
Product (Product is a material that is manufactured and branded by one company. Products come with warranties and ASTM approvals because a manufacturer invests in the ASTM approval process.)	ADA / ASTM 1951	CPSC / ASTM 1292 / 2223		Contractor	Facilities	Sweeping / blowing	Rinsing / Pressure washing	Raking / Grooming	Frequency	Reseal or Retop	Frequency	Remove & replace	Reglue / reseal	Who can repair	Dependent on proper maintenance / design			Temperatures	Solar Reflectance Index (at least 0.29) color options	Water ruse	Stormwater permeability	Possible pollution	Heat-Related Illness, Burns	Chemicals of Concern <sup>8</sup>	Splinters		
<b>Rubber tiles</b> such as Burke, Surface America, and Tot Turf	Y	B	H	X		X	X		L	N/A	N/A	Tiles	Tiles	Contractor or Facilities	up to 10 years	Petroleum	Landfill	Significantly increases heat. Lighter colors may reduce heat increase.	Y	N/A	N	Y <sup>5</sup>	Y <sup>6</sup>	Y		N	L - M <sup>9</sup>
<b>Poured-in-place rubber (PIP)</b> such as Playpour, Surface America, and Tot Turf	Y	B	M	X		X	X		L	Reseal	2 to 3 years	Topping surface		Contractor	up to 5 to 7 years	Petroleum	Landfill	Significantly increases heat. Lighter colors may reduce heat increase.	Y	N/A	Y	Y <sup>5</sup>	Y <sup>6</sup>	Y		N	L - M <sup>9</sup>
<b>Engineered Cork Surfacing</b> such as Corkeen	Y	B	M	X		X	X		L	Reseal	2 years	Topping surface		Contractor	5 years	Bark from cork forests <sup>3</sup>	Reusable	Moderates temperatures	N/A	N/A	Y	N			N	L	
<b>Artificial turf with safety surfacing</b> such as TigerTurf and Tot Turf	Y	B	M	X			X	X	M	Retop	3 to 5 years	Turf	Reseal seams	Contractor	up to 8 to 10 years	Petroleum, Cork	Landfill	Significantly increases heat	N	L	Y	Y <sup>5</sup>	D <sup>7</sup>	Y		N	L
<b>Engineered wood fiber (EWF)</b> such as Fibar, Jet Mulch and TotTurf	Y <sup>1</sup>	A	L	X	X	X		X	H	Retop	1 to 5 years	Rubber mats		Contractor or Facilities	15+ years	Wood <sup>4</sup>	Biodegradable	Moderates temperatures	N/A	N/A	Y	N		X	Y	M	

TABLE 3: KEY

- <sup>1</sup> with approved rubber mats at high traffic areas such as slide exit zones or in hybrid with PIP rubber for path of travel and high traffic areas.
- <sup>A</sup> Meets ASTM F-2223 requirements and protects against head and neck injury and long bone fractures
- <sup>B</sup> Meets ASTM F-2223 minimum requirements protecting against head and neck injury
- <sup>2</sup> How well the surface provides cushion from falls.
- <sup>3</sup> Bark removal does not harm trees. Forest prevents soil degradation, make soils more productive, regulates the water cycle, and combats climate change.
- <sup>4</sup> Raw wood that meets specific particle size, consistency, purity, and drainage standards per ASTM 2075. Tested for absence of CCA
- <sup>5</sup> Stormwater pollution—crumb rubber leaches zinc. (source: EPA)
- <sup>6</sup> PIP rubber and crumb rubber fill artificial turf temperatures can exceed CPSC temperature thresholds per readings locally by a non-profit as well as studies that have been published.
- <sup>7</sup> If using Cork infill, excessive heat & chemical concerns do not apply
- <sup>8</sup> Chemicals of concern found in crumb rubber: known human carcinogens (Benzene, Reasonably anticipated human carcinogens (Styrene, Polycyclic aromatic hydrocarbons (PAHs)), Neurotoxicants (Lead, Zinc, VOCs and SVOCs), Respiratory irritants (Chromium, VOCs and SVOCs, Crystalline Silica, Particulate matter), Reproductive toxicant (Phthalates), Allergen (Latex).
- <sup>9</sup> dependent on design. Can foster creative play if design incorporates open-ended design elements that children can interpret for imaginative play.

## 5. Engineered wood fiber (EWF)

### a. Considerations

- Consider that this surfacing is ADA accessible, inexpensive, lowers temperatures, is permeable, and provides the best ASTM-approved attenuated surfacing for preventing long bone fractures.
- When using EWF for safety surfacing, install with either another ADA accessible surfacing for all ADA access points and paths of travel or with the appropriate ramps at access points and rubber matting in high traffic areas. The matting can reduce maintenance.
- Design the layout of the space to contain the loose material. Include a threshold at the paths that connect to fixed paving material.
- Because it is a loose material and can clog the storm drain system, planting and grading should be used to minimize wood chips getting into nearby catch basins and area drains.
- When using EWF, install at a greater depth than the minimum requirement to ensure that the surfacing meets ASTM with use. The minimum amount should be 1.25% and preferably higher at install. The minimum height for surfacing depth must be indicated on the posts of the play equipment and/or the depth should be measured regularly as part of standard maintenance checks.
- **Maintenance:** Rake EWF occasionally to meet ADA. Replenish EWF every one to three years to maintain the appropriate depth to meet ADA and/or ASTM F2223-10. Actual quantities and timing of replacement of EWF will depend on site conditions, use patterns, drainage, and size of space.

### b. Reference Details

- 2730.06 EWF / Mulch



Corkeen play surfacing with standing logs.



Artificial turf at Sankofa United Elementary School, OUSD.



Engineered wood fiber at ICS-TCN César Chávez Campus, OUSD.

## 2800 Site Furnishings

Site furnishings encompass a broad grouping of objects that are installed in outdoor built spaces to make spaces more comfortable and usable. When planned and chosen properly, site furnishings create spaces that enhance learning and social engagement. In an OUSD living schoolyard site furnishings provide comfortable places to eat, stand at for hands-on learning, sit, grow plants, and store loose play parts and outdoor learning tools and materials and more. Where possible select furnishings that provide multiple functions and flexibility of use for students, teachers and the community. Site furnishings include: tables and counters, seating, lighting, bike parking, waste stream bins, planters, nature exploration elements, storage, portable sinks, and drinking water access. Shade structures require DSA review including structural engineering calculations and should be designed on a site-by-site basis for comfort and to match the aesthetics of the school.

The following Principles will help ensure that the site reflects the culture, is comfortable and functional, is rich with learning opportunities, is code compliant, and is maintainable.

### a. Considerations for 2800

For site furnishings the general Principles include the following:

- Select site furnishings that send a subconscious message that children are worthy.
- Select site furnishings that are inclusive for accessibility and provide options in a scale for smaller children in pre-K and K yards.

- Where possible, select site furnishings that provide for multiple functions and foster learning, play and social activities.
- Select materials that are comfortable to use in hot and cold weather for that site.
- Select furnishings that consider durability and ease of maintenance, resist vandalism and include skateboard deterrents.
- Follow the CHPS guidelines.

Principles that specifically relate to the selection and placement of furnishing to enhance outdoor learning include the following:

- Locate outdoor learning away from noisy streets, near learning opportunities (and gardens) and close to the storage location for outdoor teaching tools and equipment.
- Design to accommodate an entire class. The purpose of providing a class-size seating area is to create a space for an entire class to gather outside at the start and end of an activity.
- Provide enough space to accommodate the maximum number of students who may be involved in the outdoor class. The maximum spacing should be 20 feet to ensure that all can be heard during the lesson.
- Provide protection from the sun, wind, and rain by planting trees, or building shade structures over the area.
- Orient the outdoor learning areas to face away from the sun (either north or west facing or in a heavily shaded grove).
- Orient furnishings so students face away from distractions and towards a calming focal point or backdrop. For example, orient them away from the soccer field and towards a quiet corner.
- Provide enough space for instructors to display items and for students to engage in the lesson.



## 1. Tables and counters

Can be selected and sited to be used for outdoor classrooms, eating, hands-on learning, and social occasions.

### a. Considerations

- Select and site tables and counters for functional layout and the maximum number of students anticipated.
- Consider placement of tables and counters for daily, weekly, and special school events.
- Integrate the ADA options for the tables or counters into the grouping.
- Select tables that can be surface mounted for easy repair/ replacement if needed.
- Select tables that can be used for outdoor education where locations offer nearby curriculum.
- Consider offering tables or counters in two sizes; one for adults and taller children and one for shorter children.
- **Layout:** Locate tables and counters in a variety of places within the schoolyard and create configurations that support outdoor learning needs, community gatherings, and eating.
- **Materials:**
  - **Wood:** Consider wood because it provides comfortable seating by being warmer than ambient air temperatures in the colder months and cooler in the hotter months. If wood is selected, it should be sustainably sourced and splinter-resistant such as high quality FSC Cumaru and thermally-treated wood. Other options include: Cedar, Douglas Fir, and Redwood. When selecting wood check with manufacturer on the grade of wood, warranty for the wood, and examples nearby that have been installed for several years. Consider that Maintenance be made aware the wood should never be



Tables and mosaic bench at ICS-TCN Cesar Chavez Campus, OUSD.



Tables at Sankofa United Elementary School, OUSD.



Counter at Wood Oven Prep area at The Center, OUSD.

## 2800 Site Furnishings

pressure-washed as this causes splinters.

- **Concrete:** Consider that concrete provides easy maintenance furnishings but is colder in the cold months and hotter in the hot months. If concrete is selected, it should have recycled content, low to no-fly ash content, and come in colors that meet CHPS.
- **Metal:** Consider that metal is easiest to maintain as galvanized steel or powder coated metal.
- **Recycled Plastic:** When selecting furnishings with recycled plastic review the support frame to ensure the plastic will not sag with time. Review the colors for UV resistance and SRI values.
- **Umbrellas:** If adding umbrellas to tables consider: (1) fabric type for all weather resilience; (2) including umbrellas with a tilt function to maximize shade capabilities; (3) the size of the umbrella in relation to the space; (4) proper anchoring for weather events; and (5) the color scheme of exterior features on site. Umbrellas shall be considered furniture elements and not attached to the building per DSA IRA-22 Appendix: Construction Projects and Items Eligible for Exemption. DSA may require review.
- **Maintenance:** Select tables that create minimal maintenance for OUSD Buildings and Grounds. If wood is selected, a maintenance plan shall be developed with Buildings and Grounds in the early design stages to address periodic maintenance if required.

#### b. Reference Details

- 2800.01 Counter / Table

#### c. Codes and Benchmarks

- The Americans with Disabilities Act (ADA)
- Formerly American Society for Testing Materials (ASTM)
- Collaborative for High Performing Schools (CHPS) SS C9.1 and MW.C3.1

## 2. Seating

This section focuses on primary seating with a few notes on secondary seating. Objects we identify as places to sit such as chairs and benches. These objects can be in places for outdoor classrooms, places to sit in the yard, at supervision points, and places that welcome family members as they wait at pick-up and drop-off. Secondary seating are places that serve other functions that can also be used as seats. These include retaining walls, steps, boulders and logs.

#### a. Considerations

- Arrange seating for social seating and/or informal outdoor classrooms.
- Make sure the seating is accessible to all students (or similar seating nearby).
- Consider opportunities to incorporate secondary seating into built features, slopes, and natural elements such as boulders or logs.
- Supply some form of movable seating such as logs or stumps that will allow students to create their own arrangements.
- Consider placement of seating for daily, weekly, and school events.
- Select seating that can be surface-mounted for easy repair/replacement if needed.
- Select seating that can be used for outdoor education where locations include nearby curriculum.
- Consider offering seating in two sizes; one for adult and taller children and one for shorter children.
- **Layout:** Place seating in a variety of locations within the schoolyard in configurations that encourage socialization such as L-shaped or semi-circular layouts.

## 2800 Site Furnishings

- **Materials:**

- **Wood:** Consider wood because it provides comfortable seating by being warmer than ambient air temperatures in the colder months and cooler in the hotter months. If wood is selected, it should be sustainably sourced and splinter-resistant such as high quality FSC Cumaru. Other options include: Cedar, Douglas Fir, and Redwood. When selecting wood check with manufacturer on the grade of wood, warranty for the wood, and examples nearby that have been installed for several years.
- **Concrete:** Consider that concrete provides easy maintenance furnishings but is colder in the cold months and hotter in the hot months. If concrete is selected, it should have recycled content, low to no-fly ash content, and come in colors that meet CHPS.
- **Metal:** Consider that metal is easiest to maintain as galvanized steel or powder coated metal.
- **Recycled Plastic:** When selecting furnishings with recycled plastic, Review the support frame to ensure the plastic will not sag with time. Review the colors for UV resistance.
- **Boulders:** Consider that Boulders are generally good informal seats because they often contain crystals and textures that support science curriculum and cognitive and sensory development. See more on this in the Nature Exploration Elements below.
- **Natural building materials:** Consider natural building materials such as cob or adobe for community build elements. Seating made from these materials will require design review and approval by the OUSD's Garden Council for location, layout, and detailing.
- **Logs and Tree Rounds:** Consider that movable and fixed tree rounds and fixed logs are versatile, however they will



Tree stumps at Markham Elementary School, OUSD.



Seating at Leonard R. Flynn Elementary School, SFUSD.



Seating arranged to socialize., Mills College Children's School, Oakland.

2800 Site Furnishings

require more maintenance than boulders. See more on this in the Nature Exploration Elements below.

- **Maintenance:** Select all primary seating elements to create minimal maintenance for OUSD Buildings and Grounds. If wood is selected a maintenance plan shall be developed with Buildings and Grounds in the early design stages to address periodic maintenance if required.

**b. Reference Details**

- 2800.05 Single Boulder Seating
- 2800.06 Multiple Boulder Seating
- 2800.07 Fixed Log Seating
- 2800.08 Fixed Tree Round Seating
- 2800.09 Moveable Tree Round Seating

**c. Codes and Benchmarks**

- The Americans with Disabilities Act (ADA)
- Formerly American Society for Testing Materials (ASTM)
- Collaborative for High Performing Schools (CHPS) SS C9.1and MW.C3.1



Tiled circular seating at Marshall Elementary School, SFUSD.



Movable stump seating at The Center, OUSD.

### 3. Lighting

All lighting fixtures need to be dark sky compliant: (1) only on as needed by using motion detectors and light sensors; (2) only light the area that needs the light; (3) be no brighter than necessary; (4) minimize blue light emissions; and (4) eliminate upward-directed light.

#### c. Codes and Benchmarks

- CBC and CALGreen 5.106.8
- Collaborative for High Performing Schools (CHPS) SS P8.0 and SS C88.1

### 4. Bike Parking

Bike parking shall include long and short-term parking and shall be located on site for ease of entry and bike safety to encourage biking to school.

#### c. Codes and Benchmarks

- CBC and CALGreen 5.106.4.2
- Collaborative for High Performing Schools (CHPS) SS P6.0 and SS 6.1

### 5. Waste Stream Bins

Waste Stream Bins can be selected and sited to provide depositories for the three waste streams: compost, recycling, and landfill.

#### a. Considerations

- Provide waste bins which are appropriately sized for the three waste streams in relation to size of space and site population.

- Include OUSD Custodial in the discussion of selection of waste stream bins and ensure these are on the Custodial run sheets.
- Select bins that address waste migration.
- **Layout:** All waste bins shall be placed near eating areas and high traffic areas.
- **Materials:** Shall be made of materials that stand up to the weather and are easy for OUSD Custodial to maintain.

#### c. Codes and Benchmarks

- California AB827 and SB1383
- CBC and CALGreen 5.410.1
- Collaborative for High Performing Schools (CHPS) SS P6.0 and SS 6.1

### 6. Planters

Planters may be used for Outdoor Learning Environments, edible gardens, planting areas that do not have adequate in-ground soil, and as dividers on patio spaces between adjacent classrooms.

#### a. Considerations

- Develop planter dimensions in relation to the size of lumber, 4'x8', and develop the design for ease of construction and less board waste. Designs should be derivatives of 2-feet.
- Integrate the only DSA approved accessible planter option into the space if children will be using the planters.
- Consider designs that include secondary seating options and other multi-functional elements at edges of planters.
- Review planter locations and materials with the Health and

2800 Site Furnishings

Wellness/Education and Community Programming Team @ The Center and use the [OUSD School Gardens Toolkit](#) as a guide.

- Ensure that all planters are maintained by a garden steward and/or liaison; see the [OUSD School Gardens Toolkit](#).
- **Layout:** Planters should be in areas where plants will receive enough sun to thrive and where drainage from the planter does not cross a path of travel. Planters shall NOT interfere with emergency egress paths or emergency vehicle access. Planters shall be laid out to integrate ADA accessibility by providing accessible pathways to ADA approved planters
- **Materials:** Planters can be made from stock tanks, wood (see detail for specific types), corrugated metal or raw steel, and other non-toxic materials. Note that planters require a means of drainage.
- **Maintenance:** All plants in planters will be maintained by on site stewards. Beds may include maintenance such as sanding to prevent splintering; replacing wood; and eventual replacement.

**b. Reference Details**

- 2800.02 ADA Raised Planter Bed
- 2800.03 Raised Planter Bed
- 2800.04 Stock Tank Planters

**7. Nature Exploration Elements**

These elements are easy to construct and provide learning opportunities related to ecology and science, foster creative play, and act as secondary seating. These elements may be located in Nature Exploration Areas which include pollinator gardens, chapparal slopes, forests, stormwater retention gardens, dry creeks, or other ecological settings fitting to the site.



### a. Considerations

- Observe students at play, if refining an existing NEA, to determine where students currently gather and what activities take place in those areas to match with the use in that area.
- Make sure to integrate accessibility in these elements to all students (or similar seating nearby).
- **Layout:** Locate away from paths and cluster elements to avoid tripping hazards.
- **Boulders:**
  - Select boulders that do not have sharp edges and have enough texture that they are not slippery when wet.
  - Select boulders that offer curriculum related to geology and/or history.
- **Fixed Logs and Tree Rounds:**
  - Select rounds which are solid hardwood (Cedar or Redwood) and peeled. An exception to this would be in a naturalized informal areas where the bark left on the logs offers opportunities for scientific inquiry.
  - Choose to sculpt and seal fixed logs and rounds to protect their longevity.
  - Level logs on two sides or set into the ground to prevent rolling.
- **Movable Stump Seating:**
  - Select stumps that are solid hardwood (Cedar or Redwood) and provided in dimensions that will not tip, where width is greater than the height. Source stumps from a reliable source to ensure wood is not contaminated with potential pathogens which could spread to the plants and trees.
- **Maintenance:**
  - Understand that boulders should not require any maintenance.



Students gathering on boulders at recess, Mills College Children's School, Oakland.



Student hanging out on log at Markham Elementary School, OUSD.



Stump seating at Sankofa Elementary School, OUSD.

2800 Site Furnishings

- Routinely check fixed logs and tree rounds for occasional sanding.
- Replace logs approximately every 8 to 10 years to accommodate for weathering. The rate of weathering will depend on the size of the log, use, and climate.
- Moveable tree rounds should be routinely checked for decomposition state and removed when deemed that state of decay has become a hazard.

**b. Reference Details**

- 2800.05 Single Boulder Seating
- 2800.06 Multiple Boulder Seating
- 2800.07 Fixed Log Seating

- 2800.08 Fixed Tree Round Seating
- 2800.09 Moveable Stump Seating

**c. Codes and Benchmarks**

- The Americans with Disabilities Act (ADA)

**8. Storage**

Storage is necessary for all loose parts for learning and play.

**a. Considerations**

- Storage structure needs to be adequate size with a minimum tool shed size of 6'x6'
- Permanent, but easily accessible, location agreed upon by OUSD staff.
- Storage structure to be selected or designed to prevent break-ins and vandalism.

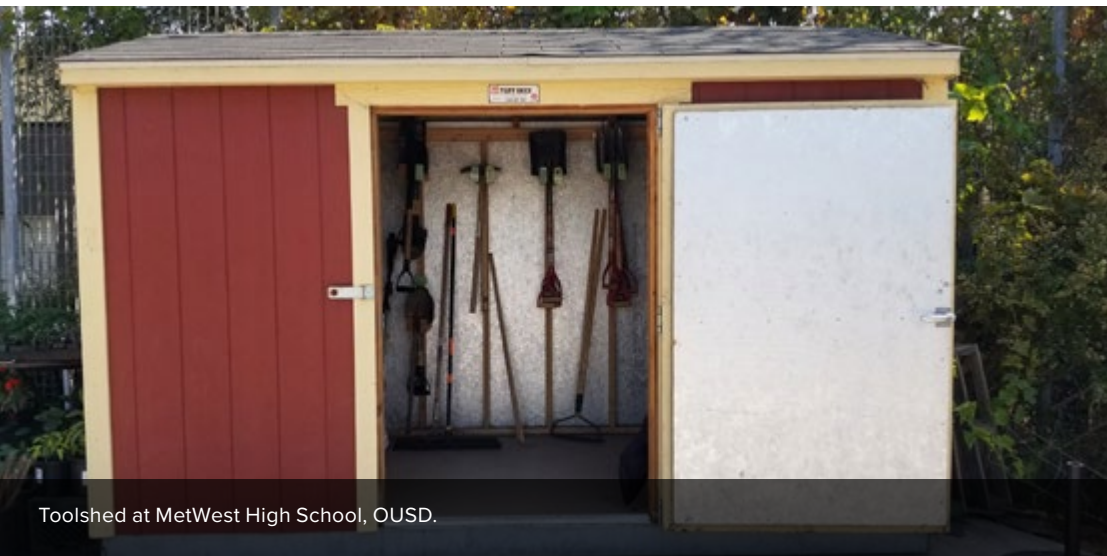

Toolshed at MetWest High School, OUSD.



Tools organized in shed at MetWest High School, OUSD.



## 2800 Site Furnishings

- Storage should be kept locked when not in use, multiple keys should be purchased so keys can go to designated stakeholders such as the garden educator, office staff, and Custodial.
- Shelving and bins should be included in storage system such that organization can happen immediately and with ease.
- Purpose of storage is for educational materials, adult and child-sized maintenance and stewardship tools, ball and active play elements, and loose play parts (movable and smaller open storage elements - see loose parts section).

**c. Codes and Benchmarks**

- California Building Code (CBC) and CalGreen
- The Americans with Disabilities Act (ADA)

**9. Water and Electrical Access**

It is critical for any living schoolyard or garden to have an easily accessible drinking water, hose bib, and electrical outlets.

**a. Considerations**

- Provide potable drinking water in the schoolyard. Install a drinking fountain and/or water bottle filling station in areas that children have access to during recess.
- Test water quality before install and ensure drinking fountain and/or water bottle filling station is up to code for water quality.
- When installing drinking water access use the Elkay–E2H2O, Most Dependable Fountains 10485WMSS, or similar and install per current plumbing codes for drinking water.
- Install hose bibs within 50' of any area requiring water for planting or other purposes. Hose bib location and design must be accessible.
- Install hose bibs where volunteer installed or seasonal drip irrigation will be required to support the living schoolyard plantings.
- Install electrical outlets in locations where electrical tools support outdoor teaching or are needed by stewards or workday volunteers.
- Outdoor sinks require approval by several agencies for health



Outdoor sink at Montclair Elementary School, OUSD.

2831 Fencing

reasons both related to managing the spread of viruses and germs and controlling mosquitos. Portable outdoor sinks that are NSF certified are available and affordable but will need to be stored near the garden with access to potable water and a janitorial sink. When working on a Modernization project, sinks may be integrated into the design to provide a covered space that meets codes and is accessible to the garden area. Reference Details

- 2900.35 Hose bib

**c. Codes and Benchmarks**

- California Building Code (CBC) and CalGreen
- The Americans with Disabilities Act (ADA)
- California Retail Food Code (CalCode)



Fencing separating ball play areas from garden at Leonard R. Flynn Elementary School, SFUSD.

## 2831 Fencing

There are many spaces and functions in OUSD living schoolyards. Appropriate fencing located at edges provides separation of activities and protection or visual demarcations for areas that are not intended for full access during recess times. These fences can be designed to be pleasant visual indicators and serve the children’s needs while also lessening the maintenance that would be required otherwise. These are guidelines and not requirements. Fencing at each site should be installed only as needed to lessen the visual chaos. Height of fencing and edges of area require fencing may vary based on needs.

### a. Considerations

- Install fencing only where it is needed to protect areas or define “rooms” that require a fence barrier such as a school garden.
- Use changes in topography, planting, logs and other options with learning and play affordances before using fencing.
- Keep fencing to lowest height necessary to minimize visual barriers throughout the yard.
- Soften the presence of fencing with planting, art by the students, or other element where feasible.
- **Layout:**
  - When locating fencing consider circulation and the necessary openings and/or gates for daily, weekly, and event functions as well as maintenance and emergency access. Circulation may include the need for pickup trucks to gardens for deliveries and a ride mower in locations



Fencing demarcating stormwater area at Markham Elementary School, OUSD.

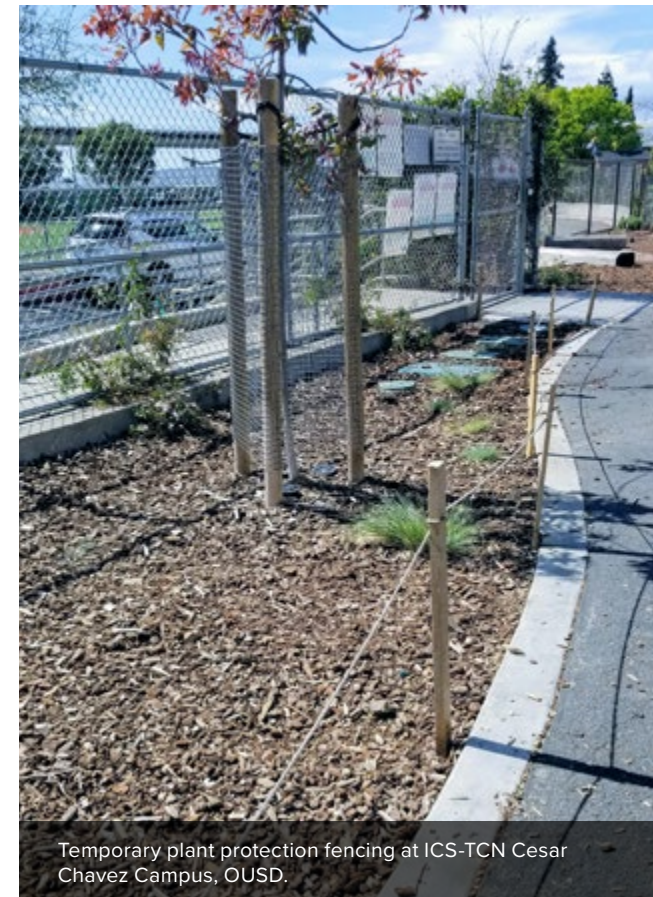

Temporary plant protection fencing at ICS-TCN Cesar Chavez Campus, OUSD.

**2831 Fencing**

with living turf. The OUSD ride mower requires a 103” wide opening.

- Install ball play fencing where balls disrupt the adjacent quality experience and/or where children lose balls down slopes, etc. during ball play and their quality of play is disrupted. Install ball fencing where built elements need to be separated from children for their safety such as raised beds or large trees.
- Install outdoor room separator fence to establish areas that are off limits from the “main” area of the schoolyard. This may be an outdoor learning area, ecological space, or space dedicated to a special class such as Kindergarten.
- Install the stormwater fence as a visual demarcation for off-limit areas to protect the soil from being compacted and the plants trampled.
- Install the establishment fence around newly planted areas to demarcate off-limit areas while the new plantings are becoming established.
- Include a “separator” at finished grade when installing a fence adjacent to loose materials that may migrate from one side of the fence to the other. The separator may include planting, a curb, steel edging, or other element that will contain the loose ground surfacing material.

• **Materials:**

- When new fences are installed that do not follow the reference details in this section avoid using materials that connote a feeling of a prison.
- All materials shall be high quality and compliment the architecture of the site buildings.
- Generally, materials should be neutral colors that do not draw the eye but allow the fence to “fade” into the surroundings.



A range of play equipment and separator fencing at Oxford Elementary School, BUSD.



Students creatively using hoop as “Shoe God” at Sequoia Elementary School, OUSD.

2882 Play Equipment

**b. Reference Details**

- 2831.01 Ball Play Fencing
- 2831.02 Outdoor Room Separator Fence
- 2831.03 Stormwater Fence
- 2831.04 Establishment Fence for New Planting Areas

**c. Codes and Benchmarks**

- ADA – when installing gates
- California Building Code (CBC) and CalGreen
- Collaborative for High Performance Schools (CHPS) for material types



Fences separate different play areas, ICS/TCN Cesar Chavez Campus, OUSD.



Garden area protected from ball play and after-hours visits, Markham Elementary School, OUSD.



Students till soil next to a garden separator fence, Melrose Leadership Academy, OUSD.

## 2882 Play Equipment

Play is developmental learning that follows intrinsic interests of the child. The purpose of play equipment is to support those interests during play times. High quality play equipment provides children with opportunities to develop their sensory systems; develop their executive function and creativity skills; while socializing with their peers or on their own; and being in a state of flow. The chosen equipment should foster development opportunities that do not otherwise exist in the schoolyard.

The subsections below provide some general principles for selecting play equipment and direction on adding loose parts play to schoolyards.

### 1. Selecting Play Equipment

OUSD schoolyards have many different forms of play equipment. This section provides general ideas to assist designers, OUSD Facilities, Principals, and community members in selecting equipment that supports the development of children.

#### a. Considerations

- All equipment must meet the performance specifications of ASTM 1487 and the ADA.
- Select equipment that offers activities that cannot be found on the schoolyard.
- Select play equipment that has high play value.
  - opportunities to develop in tandem (gross motor, vestibular, proprioceptive, tactile, and visual skills);
  - encourages collaborative use, executive function, social play, and/or creative play;
  - includes graduated levels of challenge;
  - has multiple uses or can be used in “open-ended” ways will support children’s cognitive and creative development more than unidirectional equipment such as stairs up and slide down; and
  - includes integrated shade canopies if there are no adjacent trees.
- Integrate equipment into a circuit of play with individual pieces rather than one large structure when possible. This option will cost less to install; spread out the play opportunities; and provide for higher quality play experiences for the overall student population.
- Equipment that is not ASTM certified may be installed if it meets ASTM 1487 performance specifications, is assessed for risk by a CPSI, and is designed to best practices. OUSD Facilities



Loose gravel acts as play elements.



Play opportunities within a living schoolyard at Sequoia Elementary School, OUSD.

will need to review and approve proposed design and details when proposed play equipment does not come with an ASTM certification.

## 2. Loose Parts Play

This section focuses how to provide space and storage for loose play parts in a living schoolyard.

### a. Considerations

- Develop a dedicated zone for loose parts.
- Determine the scale of loose part play intended for the space to appropriately size the area.
- Provide adequate storage space and containers for loose parts near the area for loose part play. All parts must be properly stored when not in use.
- Match the type of storage to the types of loose parts and design the storage so the children can easily put the parts back into storage at the end of the play period.
- Consider planting trees or shrubs nearby that will supply loose parts such as pinecones, acorns, and seed pods.
- **Layout:**
  - Locate in an area away from ball and active play and high traffic paths.
  - Maintain required access for emergency vehicles.
  - Provide adequate space for intended loose parts.
  - Provide the needed built elements to support the specific loose parts program which may include a patio, “mud”



Large loose parts foster collaboration and creative play.

2900 Landscaping

kitchen, seating, “work” tables, support posts, boulders, or other elements. See storage section above for storage guidelines.

• **Storage:**

- Provide appropriate storage containers and shelving for organizing the loose parts elements.
- If using doors, they should be wide enough to easily access the interior – double doors on the longest side of a large container work well.
- Use open boxes or bays to allow for easy access and for materials to be sorted easily
- Create child-friendly signage to show what is stored where.
- Do not be too specific on storage locations which can slow down clean-up by requiring too much sorting.
- Site storage in the area where loose parts will be used and if possible, on the way that children will take to leave the play space.
- Consider several smaller storage areas versus one large one to space out activity. The proposed design will need to meet clear goals and be reviewed and approved by OUSD Facilities and Custodial.
- Design storage for children to access without entering a covered shed. If a shed is needed for children to enter, it will require DSA review.



Harvesting in the garden on March 13, 2020. The last day before shutdown from the Pandemic, in the Hoover Elementary School garden.



## 2900 Landscaping

Landscaping is an integral part of any OUSD living schoolyard. Landscaping includes existing and new trees, plants, irrigation systems, the soil system and associated ecological features. Where feasible protect existing natural areas, healthy and mature trees, and native shrubs on site. Trees and shrubs provide ecological, economic, and health benefits, as well as learning opportunities.

The following principles will help to ensure that the site is unique to its place in Oakland, comfortable for the students, rich with learning opportunities, and maintainable by OUSD and the site stewards.

For **Trees and Shrubs general Principles** include the following:

- Select plants for location of sun exposure throughout the year.
- Consider size and location of planting space in yard and proximity of activities and overhead obstructions.
- Provide optimum growing conditions to support long-term plant survival and growth.
- Ensure that there is a reliable water source nearby.
- Understand soil needs and structure including type, porosity, pH, and compaction.
- Consider planting native trees species whose phenology is timed to support local birds and other beneficial native habitat such as butterflies.
- Contribute to local habitat for flora and fauna health in Oakland by considering all OUSD land as one large mosaic rather than choosing trees on a site-by-site basis.



Plants provide scale, shade, and softness, Sankofa Elementary School, OUSD.  
*Lisa Howard, Bay Tree Design*



Planting day at Brookfield Elementary School, OUSD.  
*Kat Romo, OUSD*

- Avoid species that are listed as invasive on the California Invasive Plant Council (Cal-IPC) list

## 1. Trees

Trees are a long-term investment that can provide many assets to a campus. Healthy trees and diverse groves are a key element of any living schoolyard. In addition to the general principles at the beginning of the landscape section follow these additional principles. The list of approved trees for OUSD is included as [Appendix B: Tree List](#).

### a. Considerations

- Protect existing mature and healthy trees where possible by avoiding work in the tree's driplines - cutting roots, changing the grade, compacting the soil, stockpiling construction supplies, or moving heavy equipment - in this area.
- Provide shade cover to at least 20% schoolyard (not including ball play areas) and 50% in parking areas.
- Select species that will adapt to and thrive with climate change - increased temperature changes, decreased annual rain fall, and increased wind events - at that site.
- Select species that will add climate resilience to the site by providing stormwater functions, cooling to urban heat islands, and phytobuffering to schools with poor air quality. Provide equity throughout Oakland by studying the GIS data of each site to determine the needs and provide trees that respond to these climate resilient needs.
- Use trees to provide shade. Shade needs to be where the children are, and trees can provide shade that reduces ambient temperatures more significantly than built shade structures.
- Select trees, in the areas where children have daily access, to be vigorous and hardy.
- Consider planting a variety of sizes of trees to maximize immediate and long-term shade needs, as well as stagger life cycle replacement needs.
- Create an environment for trees to thrive which includes good soil structure (for nutrients and drainage), the appropriate level of water, and proper sun exposure per species. Trees also thrive when planted in multi-species groves rather than as single trees and/or single species.
- Provide protection to trees during establishment period.
- Species selection and location in the schoolyard - Selecting trees species that are appropriate for the function of an area will lessen the maintenance burden while strategically adding trees to schoolyards.
  - Consider that different species are appropriate in different areas of the schoolyard. Trees that may tend to be messier or have more surface roots should be planted in larger planting areas, Nature Exploration Areas, and Outdoor Learning Environments. While tree species that tend to be neater (less leaf drop) and have deeper roots should be located near paved areas where there is high traffic and by active ball play areas.
  - Create a selection of deciduous and evergreen trees for each site. These types of trees should be located in ways that help the site. Evergreen trees are excellent wind buffers, air buffers for schools located near highways or large arterial roads, and slow down stormwater runoff. Deciduous trees provide seasonal shade and act as harbingers of the seasons.
  - Consider shade and cooling when choosing locations for trees and species of trees. Winter shade should allow for transmission of sufficient levels of heat and light. Spring to Fall shade provision should minimize UV exposure as well as reduce heat and light in the yard and adjacent classrooms.

## 2900 Landscaping

- Site deciduous trees on the southeast, south, and southwest sides of play spaces to shade children during the hottest parts of the day or when UVs are the strongest, and to reduce the reflectivity of the paved surfaces.
- All new trees require a three-year establishment period. During this period protection should remain in place and trees may require more water, particularly during dry weather periods.
- **Layout spacing:** The following standards help ensure student safety, maintenance and emergency access, and healthy growing conditions for OUSD trees. For size of the crown at maturity refer to the OUSD tree list in [Appendix B: Tree List](#).
  - **At buildings:** Ensure that mature crown does not overlap with roof of buildings and branches do not rub against buildings.
  - **At emergency access lane:** Ensure that mature crown does not overlap with lane unless bottom of canopy is 12-feet high as a minimum. Trunks shall be placed a minimum of five feet from emergency access lane.
  - **At fencing:** Place trunks at a minimum of six feet from fence posts. Tree canopies overlapping fencing are not a concern.
  - **Near active ball play:** Do not place trees in active ball play areas but do place trees at perimeter to provide shade.
  - **Near play equipment:** Do not place trees in use zones defined by ASTM and the play equipment manufacturer. This includes the trunk at ground level and the designated play surface overhead obstruction clearance zone defined by ASTM which is 84” from the top of all equipment in ASTM 1487 9.8.4.1.
  - **Between other trees:** Determine spacing on size of mature crown and adjacent tree crowns. Trees should not overlap more than five feet to avoid branches touching in wind.
- The exception for overlap is in a multi-layered forest where smaller tree canopies may overlap with taller tree canopies when their height spacing keeps branches from touching.
- **Underground utilities:** Place trunk a minimum of 10-feet from underground utilities.
- **Berm:** Do not place trees at top of berms or within 10-feet of base of berms. This spacing will avoid possible erosion, compaction, and exposed roots.
- **Layout and Maintaining visibility:**
  - Avoid blocking night lighting or interfering with security cameras.
  - Consider patterns of supervision when placing trees.
- **Maintenance :**
  - **Design Review:** During the early design phases, work with Buildings and Grounds to ensure the new tree plan is maintainable. Leaf drop can be challenging for the custodians and gardeners. Reviewing leaf drop on paving, in planting areas, and how each area requires different levels of maintenance will help with future maintenance. Work with Buildings and Grounds team to develop a pruning schedule as part of maintenance plan.
  - **Rootable soil:** Ensure that trees are planted in rootable soil. Trees are often planted in areas that were once covered with paving and have compacted soils with poor soil structure. The ‘architecture of the soil’, i.e. rootable soil with pore space that effectively moves and stores air, water, and other nutrients, is the most critical element for success of urban trees. When trees are planted in cramped planting pits and with poor subsoil they do not grow and the roots tend to cause damage to nearby paving. The roots of a tree can be directed lower to avoid pavement damage. Different sized species need different amounts of rootable soil to thrive.

## 2900 Landscaping

Below are the ranges for rootable soil per tree size. These numbers are Guidelines which can be modified depending on the need for shade, the quality of the soil, and the placement and number of the trees. Refer to [Appendix B: Tree List](#) for tree sizing.

- **Small trees:** 800 to 1,200 cubic feet per tree
  - **Medium trees:** 1,200 to 1,600 cubic feet per tree
  - **Large trees:** 1,500 to 2,000 cubic feet per tree. 3,000 cubic feet for two to three trees.
- **Irrigation:** Ensure proper irrigation for trees so as to encourage roots to grow down as well as out to provide the necessary structure to support the tree. According to experiences by Trees for Oakland, tree diapers are problematic in many ways and are not beneficial to trees. Trees of Oakland recommends a berm and irrigation or hand watering rather than the tree diaper.
  - **Protection:** Protect trees while they are being established. Refer to the tree protection detail for more information.
    - Plant trees in beds of mulch to protect roots from traffic.
    - Install protective tree caging to protect trunks from damage and roots from compaction. Remove caging when it becomes an issue for tree health/growth and after trunk caliper is sturdy enough for children's attention.
    - Stake only when necessary. The natural movement of the trunk strengthens it and stimulates root growth. The exception is for trees planted in high clay soils, some evergreens, and slow growing species with 2 to 4" caliper trunks (depending on species) at install.
  - **Pruning:** In Nature Exploration Areas and Outdoor Learning Environments, prune trees so that the lowest branches are just five feet from the ground to allow visibility for



Pollinator plants provide smells and visitors.



Rainbow plants, Bridges Academy, OUSD.

supervision while maintaining scale and shade for the children. Tree canopies over accessible paths of travel must be pruned to allow 80” of clearance. In areas near active ball play, play equipment, or fire lanes follow Guidelines above under spacing. The lower canopy height will need to be maintained to meet the functions and codes of these areas.

- **Leaf drop:** In large planting beds, Nature Exploration Areas, and Outdoor Learning Environments leave leaf drop in place. Areas where leaf drop can be left in place will reduce maintenance while also adding nutrients to the soil, as well as play and learning opportunities. Leaf drop from paving areas may also be collected and spread in planting areas to support soil nutrition.

#### b. Reference Details

- 2900.01 Tree Planting in Soft Surface
- 2900.02 Tree Planting in Hard Surface
- 2900.05 Tree Protection
- [Appendix B: OUSD Tree List](#)

#### c. Codes and Benchmarks

- BP 3285 Vegetation
- BP 3511.2 Integrated Pest Management
- CalGreen 5.106.12.1 – 5.106.12.3
- MWELO
- CHPS SS C7.1

## 2. Plants

### a. Considerations

Plants provide environmental, educational, health and wellness assets as well as soften the space and provide identity for the school. In addition to the general principles at the beginning of the landscape section follow these additional principles. All approved plants are listed in [Appendix C: Plant List](#).

- Provide children with access to plants for learning and play. In child accessible areas, particularly play areas, the plants should be vigorous plant species and be a minimum of three feet high (knee height and thus non-steppable) before access is provided and all protection has been removed.
- Meet minimum size requirements to ensure the survival of the shrubs and success of the project.
- Avoid planting shrubs that require regular pruning or clipping.
- Select ground coverings and shrubs that provide full coverage, particularly in ornamental planting areas, so that weeding and mulch maintenance can be minimized.
- **Layout:**
  - **Location:** Choose plants for their ability to thrive (in relation to solar aspect and soil), provide the intended function (from stormwater to habitat), and in relation to the adjacent uses. For example, plants that are delicate should not be located near active ball play areas. Planting areas where children have daily access such as Nature Exploration Areas shall not be heavily planted or planted with delicate or short plants (shorter than knee height to discourage stepping on the plants).

## 2900 Landscaping

- **Soil:** Ensure that plants thrive, by providing rootable soil, i.e. not compacted, and tested as detailed in the Landscaping principles.
- **Visibility:** Place plants to provide clear site lines to main areas used by children during recess. Taller shrubs that naturally grow in a vase shape are ideal choices when sightlines need to be accommodated.

- **Maintenance**

- **Design review:** During the early design phases, work with Buildings and Grounds to ensure the new planting plan is maintainable. Native plants do not require regular pruning.
- **Irrigation:** Choose plants shall to work with MWELo and shall be irrigated as needed to thrive. If irrigation is not possible plants should be planted within 50 feet of a hose bib and a watering schedule with site stewards will need to be established. OUSD Buildings and Grounds will not be responsible for watering plants that are not on an irrigation system.
- **Protection:** Protect plants as they become established. Areas that are designed for daily access by children shall integrate the protection fencing.

- **b. Reference Details**

- 2900.03 Shrub Planting
- [Plant List \(Appendix\)](#)

- **c. Codes and Benchmarks**

- BP 3285 Vegetation
- BP 3511.2 Integrated Pest Management
- MWELo

### 3. Irrigation

This section is developed for all planting areas requiring contractor installation and OUSD Facilities and Buildings and Grounds maintenance (or proxy). Other areas of a Living Schoolyard may include volunteer installed and/or seasonal irrigation which is detailed in Chapter 4: Maintenance and Stewardship.

- **a. Considerations**

- Provide the proper amount of water to promote soil infiltration and nutrient uptake for plants to survive and thrive.
- Design the system to MWELo for the efficient use of water and provide a weather or moisture based automatic irrigation system that conserves water.
- When zoning the irrigation system, consider plant types, soil types, slope, exposure, and other field characteristics to make the system most effective and efficient.
- Install exposed infrastructure pieces to be vandal resistant and child proof.
- Designated site representative to coordinate with OUSD Buildings and Grounds (or proxy) to periodically manage controller and ensure the system is working properly particularly at the beginning of dry weather periods.
- When possible, choose simple systems that are easy to operate and repair.
- At close-out of a construction project the irrigation designer shall train onsite end users on the system and provide zone and irrigation maps to the school site, OUSD Buildings and Grounds, and OUSD Facilities.

2900 Landscaping

**b. Reference Details**

- 2900.14 Backflow Assembly – 2” & smaller reduced pressure
- 2900.15 Backflow enclosure
- 2900.16 Irrigation controller - inside wall mount
- 2900.17 Irrigation Controller - Outside wall mount
- 2900.18 Master Control Valve
- 2900.19 Flow Sensor
- 2900.20 Remote Control Valve with ball valve
- 2900.21 Drip zone kit with ball valve
- 2900.22 Valve box installation
- 2900.23 Thrust blocks
- 2900.24 Pipe & Wire trenching with tracer wire
- 2900.25 Wire connectors
- 2900.26 Gate Valve
- 2900.27 Quick Coupling Valve with angle iron
- 2900.28 Tree bubbler
- 2900.29 Shrub bubbler
- 2900.30 Pop-up sprinkler
- 2900.31 Typical Stream Bubbler
- 2900.32 Pop-up Rotor Sprinkler
- 2900.33 Pop-up Rotor Sprinkler
- 2900.34 Garden bed
- 2900.35 Hose bib

**c. Codes and Benchmarks**

- MWELO



## 10400 Signage

Signage within a living schoolyard can serve a wide variety of purposes, informing various audiences about the schoolyard, its history, its ecological features, school community values, and providing educational moments. The process of determining what information to relay and in what format can be an opportunity for community engagement and promotion of living schoolyard projects. Signage may be professionally manufactured or created with the students.

### a. Considerations

- Consider implicit and explicit messaging when developing signage content and graphics.
- Consider managing visual clutter where multiple signs already exist. This could be addressed by graphic continuity, sign placement, and hierarchy of messaging or by consolidating the signage into one sign.
- Consider placement of sign so that it is accessible but not dominant within the landscape.
- Use materials and colors similar to other site furnishings and features on site.



Living schoolyard sign at Markham Elementary School, OUSD.



Handmade signs can set a welcoming tone.



Demonstration stormwater cistern sign at Skyline High School, OUSD.



**Process**

PROJECT TYPES

PROJECT PHASES

OUSD APPROVAL PROCESS



## 03. PROCESS

### 1. PROJECT TYPES

The Project Phases and Approvals Process described below apply to projects that require permitting by the Division of State Architects (DSA) and/or necessitate the services of a landscape architect/design consultant due to design complexity. Projects need to be reviewed by the DSA when the construction budget exceeds a threshold dollar amount (this figure changes regularly, see the California DSA's website) and/or when new structures are being constructed. Further information regarding DSA exemption is summarized below.

For smaller projects such as the installation of garden beds or areas of planting, refer to [OUSD's Gardens Toolkit](#) and seek approval from OUSD's Garden Council.

#### **Exemptions from DSA Plan Review: Parameters and Considerations**

Certain alteration, reconstruction, or small new construction projects on existing public (K–12) schools, may be exempt from DSA Processing. When authorizing construction of exempt projects, the school board assumes the responsibility for employing appropriately licensed architects or registered engineers to prepare the construction documents. The school district also assumes the responsibility for employing inspectors and laboratories to provide for the required testing and inspection of materials and work of construction. Depending on the scope of the project and/or

the cost of the project there are various situations where a project may be exempt. Always refer to the Document IR A-22 for the most updated cost thresholds and project scope to find if a project may be exempt.

#### **Project Exempt Based on Project Scope Regardless of Construction Cost**

There are certain structures or items not considered a school building per California Administrative Code. For a comprehensive description of the items that do not require a plan review see appendix of the document DSA IR A-22. Note that DSA Accessibility Review may be required in certain structures that are exempt for Structural or Fire Life Safety Plan review.

#### **Project Exempt Based on Project Scope, and for Reconstruction and Alteration to School Buildings Project Cost**

Reconstruction or alteration projects to school buildings are exempt when less than:

- \$119,230 in cost (at 2022) for Structural, Fire Life Safety and Accessibility projects
- between \$119,230 and \$268,268 (at 2022) for Structural, Fire Life Safety when certain conditions are met (see DSA IR A-22 for details)

Above costs shall be determined at the completion of construction and if the final actual project cost exceeds the specified cost thresholds, the project is no longer exempt and will require submittal to DSA for approval and construction oversight.

Even with the potential exemption, the project review requirement should be discussed during the pre-application meeting.

## 2. PROJECT PHASES

An OUSD living schoolyard project may include the following phases. An appropriate work plan based on the site and scale of the project should be developed at the onset of the Project Initiation Phase.

### a. Project Selection and Initiation

Facilities approves the site, vision, budget, scope, and limit of work for project. Health and Wellness/Education and Community Programming Team @ The Center advised on existing garden infrastructure and stewardship. The scope of the project should tie into OUSD’s living schoolyard policies and curriculum goals for the school while complementing the project budget. The team may include OUSD staff, the site Principal, site teacher, NGO partners (if any), design consultants, and school community members. The roles of each team member and means of communication should be clearly defined in this phase.

### b. Analysis of Site, Relevant Codes, and Permitting Requirements

OUSD Facilities to provide base maps of the site when possible. The team will conduct site analysis including ecology, infrastructure, microclimates, circulation, use zones, and other significant factors that may impact the site design. The team will conduct a review of applicable codes, permit requirements, and identify the Authority Having Jurisdiction (AHJ) for the various components of the project. The team will define key site issues, in relation to the project scope and site analysis, and assess the existing site to identify any elements that may be out of compliance within the limit of work.

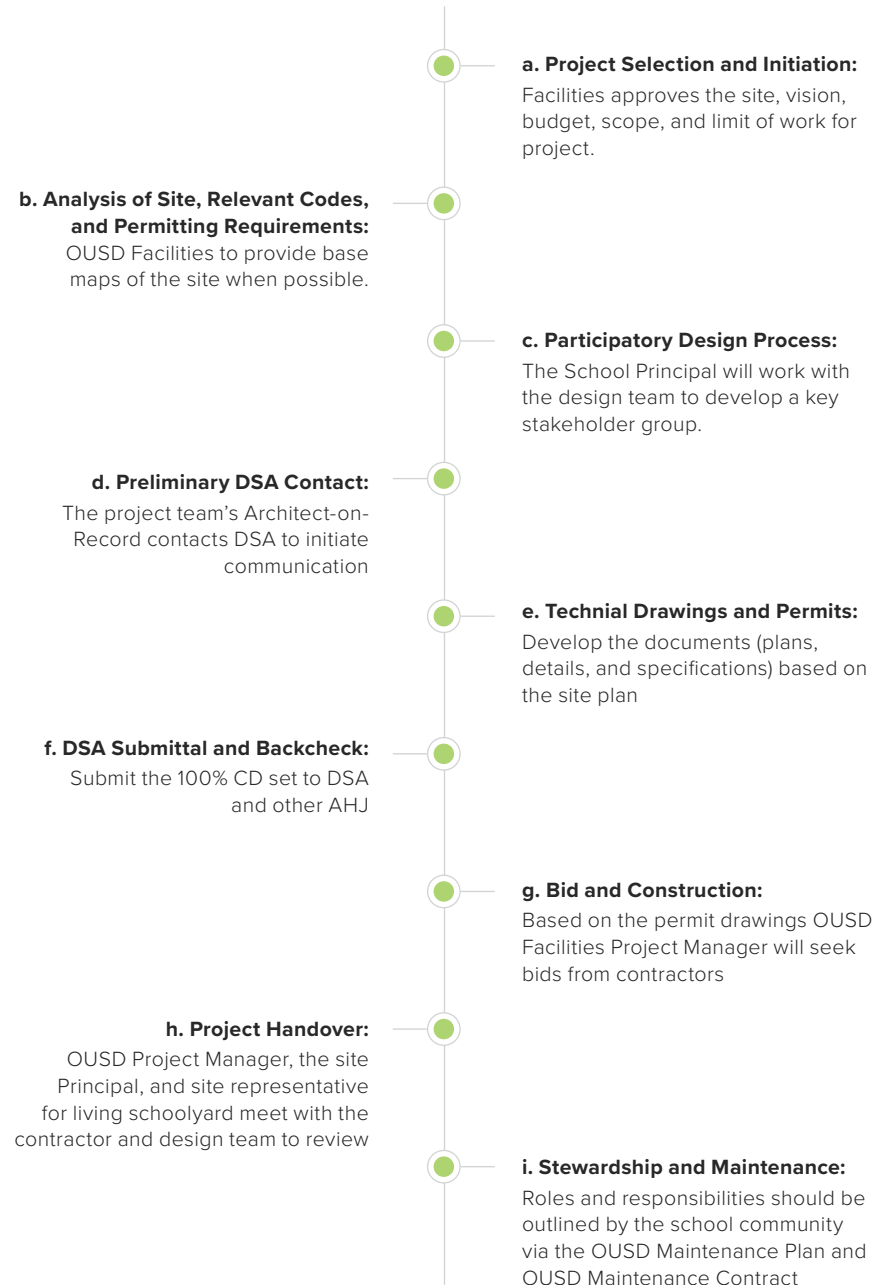

### c. Participatory Design Process

The School Principal will work with the design team to develop a key stakeholder group. The design team and stakeholder group will genuinely listen to the community, which may be comprised of site teachers and staff, students, families, neighbors, and local non-profit partners. This phase is an exchange of professional knowledge by the design team with local knowledge by the local community to develop a vision statement, goals, and a conceptual site plan for the project. If a project is small, the breadth of community engagement may match it and be abbreviated.

### d. Preliminary DSA Contact

The project team's Architect-on-Record contacts DSA to initiate communication regarding the scope, code review, and necessary submittals to clarify needed drawings and specifications for the DSA submittal in step 6 below.

### e. Technical Drawings and Permits

Develop the documents (plans, details, and specifications) based on the site plan developed in the Participatory Design Process and approved by OUSD. These drawings should match the scope of the project while providing clear direction for construction of the project and meeting all applicable codes and OUSD policies. A Preliminary submission of the project to DSA should be submitted following scope determination. This is an iterative process that requires coordination, consideration of codes, construction cost, and future maintenance and stewardship. At each stage of the design development and construction document creation review the plans with District departments and send two weeks in advance of meetings.



Collaborative, hands-on design at Melrose Leadership Academy, OUSD.



Ideas for the schoolyard at Markham Elementary, OUSD.

### f. DSA Submittal and Backcheck

Submit the 100% CD set to DSA and other AHJ and shepherd the project through any necessary review processes from the local fire marshal to DSA approval to secure the necessary permits required for the project from all authorities having jurisdiction over the project.

### g. Bid and Construction

Based on the permit drawings OUSD Facilities Project Manager will seek bids from contractors that meet the specific requirements for the project from Lease-Leaseback to competitive bidding to sole source. After contractor is approved, inspector-of-record hired (if required), and all permits are secured, proceed with construction. The contractor shall follow all Title 5, California Code of Regulations for safe construction on a school site. Contractor to meet with inspector, OUSD PM, other OUSD department reps (as needed) and design team representatives weekly and as necessary for field reviews to ensure project is built to plan. Contractor to coordinate specialized lab tests and inspections if needed and all of team to respond if special circumstances arise. Construction on schoolyards must be timed to have the least possible impact on instruction.

### h. Project Handover

At end of construction phase OUSD Project Manager, the site Principal, and site representative for living schoolyard to meet with the contractor and design team to review manuals, equipment and systems, and maintenance needs. At this meeting Contractor and Design team to provide the Record Drawings, manuals, certifications, and any other documentation that is necessary for OUSD to maintain for the site file.



Design workshop where students, teachers, family members, and community collaborate.



Drawing from student workshop.

**i. Stewardship and Maintenance**

Roles and responsibilities should be outlined by the school community via the OUSD Maintenance Plan and OUSD Maintenance Contract as part of the project handover. The roles should have been defined early in the design phase and the responsibilities should have been reviewed with each design submittal during the technical drawing phase. The plan may need refinement and revision with all responsible parties, including but not limited to OUSD Buildings & Grounds and Health and Wellness/ Education and Community Programming Team @ The Center, if any scope was changed during the construction phase.

**2. OUSD, DSA, AND AHJ APPROVAL PROCESSES**

Successful Living Schoolyard projects have buy-in from stakeholders across the school system- from the school site administrators, to the district’s facilities staff, to the DSA. Soliciting review and garnering approval from the correct body at each stage of the iterative design process ensures that the project is safe, sustainable, and meets the needs of the community that use and steward it. The Approval Process chart outlines the phases of a green schoolyard project, and the correlating approval required at each. Some projects may require additional approvals depending on site specific conditions—which would be identified during the process by District staff. This chart outlines the minimum oversight and collaboration required, not the maximum.

**APPROVALS PROCESS FOR GREEN SCHOOLYARDS**

This approvals process chart is relevant to OUSD schoolyard greening projects that require DSA approval, see narrative for DSA exemptions. Phases beyond the participatory process are contingent on the project being funded.

PROJECT PHASE	APPROVAL BODIES	APPROVAL PROCESS
Project Selection & Initiation	OSD Facilities Dept.	Facilities approves site for visioning to ensure it aligns with district plans. Health and Wellness advises on existing garden infrastructure and stewardship.
	OSD Health & Wellness Dept.	
Analysis of Site & Relevant Codes; Permitting Requirements	OSD Facilities Dept.	OSD to provide base map when possible. Conduct review of applicable codes, permit requirements, and Authority Having Jurisdiction (AHJ). Define key site issues and assess if anything within limit of work is currently out of compliance.
Participatory Design Process	School Site Admin	School principal advises on key community stakeholders to involve in engagement. Work with community to develop vision statement, goals, conceptual plan. Design components should reflect updated Guidelines and Standards.
	OSD Health & Wellness Dept.	
Preliminary DSA Contact	Division of the State Architect	DSA pre-application meeting should be scheduled to confirm the DSA processing and applicability of each discipline (Structural, Fire Life Safety and/or Accessibility) in a particular project. Pre-Application meeting should be held after the DD phase is completed. Architect, consultants, owner and/or client will be participants in the meeting. To arrange the meeting, the form DSA-91 will need to be filled.
Technical Drawings & Permits (DD, 50%CD, 90%CD, 100%CD)	OSD Facilities Dept.	Preliminary submission of project to DSA following scope determination. At each stage of design development and construction document creation: review drawing set with district depts., plan sent 2 weeks in advance of meeting. Consider maintenance and stewardship at each stage.
	OSD Health & Wellness Dept.	
	OSD Buildings & Grounds	
DSA Submittal & Backcheck	Division of State Architects	100% CD set sent to DSA for review and subsequent refinements.
Bid / Construction	OSD Facilities PM	Project Manager from OSD Facilities Dept. attends all construction meetings; other departments and stakeholders are brought in if/when specific issues arise. Punchwalk prior to final payment.
	OSD Health & Wellness Dept.	
Project Handover	OSD Buildings & Grounds	Contractor and designers review manuals and maintenance needs with OSD.
	Site Principal	
Stewardship & Maintenance	OSD Buildings & Grounds	Refine and revise preliminary maintenance and stewardship plan with responsible parties.

# **Maintenance and Stewardship**

**INTRODUCTION**

**OUSD STEWARDSHIP RESOURCES**

**KEY MAINTENANCE AND STEWARDSHIP ACTIVITIES**

**STEWARDSHIP STAKEHOLDERS**

**MAINTENANCE AND STEWARDSHIP PLAN**

**MAINTENANCE AND STEWARDSHIP BUDGET**

**STEWARDSHIP AT A GLANCE**



**04**

## 04. MAINTENANCE AND STEWARDSHIP

### 1. INTRODUCTION

Designing and building a living schoolyard is exciting and inspiring, but after the ribbon cutting, the deeper work of caring for and maintaining these dynamic, organic spaces begins. Stewardship is community-driven and should be woven into the overall culture of a school as much as possible. Like any other institution, schools are held together by relationships among people and place. Ongoing and sustained stewardship requires strong relationships between members of the school and District community, as well as with the natural world that exists in the schoolyard. This chapter's audience is the school community: site administration, teachers, parents and caregivers, community members, and anyone else involved in the living schoolyard at an OUSD site. As outlined in the Project Approval Process in Chapter 3, the school community will maintain some areas in a living schoolyard, and others will be maintained by OUSD. Clearly outlining and reviewing areas of the schoolyard and roles and responsibilities related to maintenance each year is important. This chapter provides insight and tips for those areas of the living schoolyard that are maintained by the school community.

### 2. OUSD STEWARDSHIP RESOURCES

It is important to note that OUSD has developed numerous resources that support schools in maintaining their living schoolyards and gardens. We list them here for quick reference:

#### a. OUSD School Gardens Toolkit

The OUSD School Gardens Toolkit is the District manual for starting, developing, enhancing, stewarding, and using gardens throughout OUSD. It should be referenced for specific and local guidance on school garden needs within the District.

#### b. OUSD Vegetation Policy

This policy was approved by the OUSD Board and outlines how schools and OUSD Buildings and Grounds define areas of responsibility on a schoolyard. This document gives schools clear guidance on what they can expect from Buildings and Grounds regarding living schoolyard management.

#### c. OUSD Maintenance Plan

The Maintenance Plan template provides schools with a comprehensive document to schedule and track maintenance tasks in a living schoolyard through the school year. This document covers workdays, waste management, infrastructure and repairs, irrigation, plant maintenance, and pest management. This document should be reviewed, filled out, and updated by each school site at the beginning, middle, and end of the school year.

#### d. OUSD Maintenance Contract

The OUSD Maintenance Contract outlines the stewardship responsibilities taken on by school communities and should be filled out by each school



with a garden or living schoolyard at the beginning of each year. A “Person of Record” must sign this form and attach a “Living Schoolyard Map” with the areas that the school community is responsible for clearly designated.

### **What is Stewardship and Why is it Important?**

Stewardship is an ethic that supports the care for and proper management of a place and its resources. The consistent and sustained stewardship of a living schoolyard is vitally important as the plants and ecosystems that are present will grow, die, decay, and grow again. Change is constant in a living schoolyard, but fortunately it follows a seasonal rhythm where routines can be created, as there will be times where it is necessary to manage these seasonal and lifecycle processes. But, these processes are exactly why living schoolyards are so beneficial to student learning and well-being, campus beauty, and school pride. They provide countless opportunities to discover, observe, and connect to the natural world and each other. For example, schoolyard workdays are chances for the community to come together in celebration, and student-led weeding, watering, and raking are ways students can practice stewardship, learn new skills, and take ownership and pride in their school.

This chapter outlines the key components and foundational understanding that are necessary for school communities to sustain ongoing stewardship of living schoolyards in OUSD.

## **3. KEY STEWARDSHIP ACTIVITIES**

There are a few key stewardship activities that will need to be performed by the school community on a daily and weekly basis in order to maintain a living schoolyard or garden. These activities can and should be done

by students whenever possible. Training students at the beginning of the year and developing routines around them will ensure that these tasks become part of the culture of the school.

### **a. Weeding**

Weeding is an ongoing task in any green space. The more weeds there are, the more student engagement opportunities you have. Many student hands can take care of weed patches in short order, provided they receive proper training on how to pull not only the shoot, but also the root. There are also lessons that can incorporate weeding, such as comparing fibrous and tap roots. Weeding is important as unwanted plants compete for water and nutrients with other desirable plants.

### **b. Watering**

Watering is critical for growing plants in the Bay Area climate. Irrigation systems can be installed, but student-led watering should be incorporated into a school’s irrigation plan. Students love to water. Watering cans and other rain-mimicking tools are useful and appropriate for students to use.

### **c. Mulching**

Mulching is a valuable tool against weeds and water evaporation. Mulch can be made of cardboard, woodchips, straw, compost, small rocks, or soil. Mulch should be applied around and among plantings and sheet mulching can be used to control weeds in an easy and cost-effective way. Students can make light work of large mulching activities, spreading cardboard and woodchips over a heavily weeded area.

### **d. Raking**

Rakes are an important tool to have on hand in any living schoolyard or garden setting. They can be used to clear pathways of debris, clear mulch when necessary, gather leaves and other fallen materials, and keep

garden areas looking their best. Students can safely use rakes in the living schoolyard with a little training.

### **e. Pruning**

Pruning ensures the proper growth of trees and helps clear dead, dying, or diseased parts of the tree. At least once a year, younger living schoolyard trees should be assessed for pruning. As trees mature, pruning happens less frequently.

### **f. A Note About Deadheading**

Deadheading flowering plants can help encourage more blooms. However, deadheading also takes away seedheads that can be used for teaching lessons on seed saving and plant life cycles. Students love to revisit plants and gather seeds. Seedheads are also crucial for birds, creating a better habitat for wildlife in the garden. School communities should find a balance between encouraging blooms and leaving some seed heads.

## **Stewardship, Design, and Planning**

Any new living schoolyard features or equipment added to a school should be relatively easy to understand and maintain. The following concepts are key to ensuring that students are the main stewards of their schoolyards and that they know how to interact with the space(s).

### **Child-sized Tools:**

In elementary schools, child-sized stewardship tools should be included in the budget and purchased right away. This ensures that maintenance and stewardship are incorporated into routines right away; items such as child-sized brooms, rakes, trash pickers, and gloves should be available immediately.

### **Simple Irrigation Systems:**

Any irrigation systems that are installed by the school community should be very simple such that students, new parents or caregivers, teachers, or administration can understand and maintain the system without barriers. If you have a multi-valve and line system, consider making a quick reference map that is kept in the irrigation box as well as with other living schoolyard maintenance notes. Irrigation inventory sheets should be part of any living schoolyard maintenance plan where irrigation parts and item numbers can be listed and therefore replacements can be made more easily. It's important to keep some replacement parts and batteries in a well-labeled container in the tool shed.

In addition, student-led watering should be considered in any irrigation plan. A handful of watering cans or five gallon buckets with "rain makers" (recycled yogurt containers with holes in the bottom) are an effective and efficient way to water specific garden areas and engage students in the task.

### **Supervision:**

It is important to think ahead to students' use of any living schoolyard spaces, or spaces accessible to students outside. A plan for how to train students on appropriate behavior, where and how they can access spaces, and who will supervise these spaces when students are present is critical. Consistent supervision can help students learn how to interact with particular spaces, learn what is safe, and where they are allowed to go.

## 4. STEWARDSHIP STAKEHOLDERS

It is vitally important that the relationships between all OUSD stakeholders be nourished and supported by each other. In order to do this effectively, it is also important to understand the context in which each of these stakeholders is operating. For example, OUSD currently has 12 gardeners overseeing nearly 100 school sites and other OUSD facilities. Each gardener has approximately 4 hours per week at each campus, barring emergencies at other facilities. It is extremely challenging for each of these gardeners to maintain anything on their assigned schoolyards beyond routine mowing, weed whacking, and occasional seasonal pruning. Therefore, any gardens or living schoolyard elements must be maintained by other stakeholders, and clear and consistent communications with OUSD Buildings and Grounds, including the gardeners, is critical to building goodwill and rapport.

There are many ways to support clear and consistent communications among stakeholders:

### Get Connected

School communities should reach out to and connect with their OUSD gardener. During gardener site visits, introduce yourself, ask how you can work together, and ask if you can get their contact information, such as their cell phone number or email. Help gardeners feel appreciated by sending them “thank you” notes from the school or students, or by providing a special gift at the end of the year. If a school’s “Person of Record” for the living schoolyard moves on, take time to introduce a new point person to your OUSD gardener.

### Walk The Site

After introducing yourself to your OUSD gardener, school communities should plan to walk the school site with your gardener to discuss plans, shared maintenance, and where and how the school community will fully take on stewardship. Please note that your OUSD gardener may have

very limited time for a walk and this session may need to be scheduled in advance and with approval from the OUSD Gardening and Laborer Department Manager.

### Meet

It may be helpful to hold a meeting once or twice a year with your OUSD gardener and other stakeholders to do the walk-through discussed above, and to discuss other maintenance matters.

### Stewardship Stakeholders

There are many players involved in schoolyard stewardship in OUSD. The following is a list of stakeholders and their roles related to the stewardship of OUSD living schoolyards.

#### a. OUSD Central Kitchen, Instructional Farm and Garden, and Education and Community Center: “The Center”

The Center is the home of the OUSD Education and Community Programming Team and is the hub for living schoolyard and garden support throughout OUSD.

#### b. OUSD Gardeners (OUSD Buildings and Grounds)

There are 12 gardeners who work throughout all of OUSD’s facilities on routine maintenance tasks such as mowing, weed-wacking, and occasional pruning. Each gardener has approximately 4 hours per week at each campus.

#### c. OUSD Garden Council

The OUSD Garden Council is an interdepartmental District team which meets monthly to develop and refine learning garden policies and systems, review and approve project proposals and ensure oversight and sustainability of all school learning gardens. The OUSD Garden Council

is made up of people from OUSD Risk, OUSD Buildings and Grounds, the OUSD Gardening Department, The Education Programming Team at The Center, OUSD Facilities, OUSD Sustainability, and OUSD Custodial.

#### **d. OUSD Garden Stewards/Environment-Food-Garden (EFG) Champions**

The OUSD Garden Steward and EFG roles are part of OUSD's District-wide Wellness Champion Program. Garden Stewards are responsible for stewarding their gardens and promoting student education using the garden as well as developing engagement opportunities for staff and community members.

#### **e. OUSD Custodial Staff**

OUSD custodians are important partners in stewardship at every school. Custodians are responsible for the overall cleanliness of their school sites. They should be consulted consistently and brought into conversations about schoolyard projects and management.

#### **f. OUSD Teachers**

OUSD teachers can become stewardship champions by supporting students in engaging in stewardship activities as part of instruction or during after school activities.

#### **g. OUSD Students**

Students should play a role in living schoolyard stewardship by engaging in weekly activities such as weeding, watering, litter pickup, and other tasks as necessary.

#### **h. OUSD School Communities**

School communities are made up of parents and caregivers, staff, and neighbors. Each of these constituents should all be involved in

stewardship. Communities can engage in the maintenance of a living schoolyard through various methods such as workdays, lessons that incorporate stewardship, and community watch support.

#### **i. OUSD Approved Partners**

There are many OUSD approved partners that support the stewardship of living schoolyards throughout the district. Growing Together, FoodCorps, and Climate Corps Education Outside, are all examples of approved partners that engage in stewardship of OUSD living schoolyards and gardens.

## **5. CREATING A MAINTENANCE PLAN**

Each OUSD school site should complete a Maintenance Plan in the Fall, and it should be updated in the spring or when staffing changes. The OUSD Maintenance Plan helps schools define and set goals around six different focus areas:

- 4R's (Reduce, Reuse, Recycling, Recovery)
- Infrastructure and Repair Needs
- Irrigation Systems
- Plant Maintenance
- Pest Control and Integrated Pest Management (IPM)
- Soil Bed/Prep

The OUSD Maintenance Agreement should be filled out by each school's "Person of Record" as designated in the yearly OUSD Maintenance Contract.

## 6. CREATING A STEWARDSHIP BUDGET

The ongoing stewardship of living schoolyards requires investments of time and funding. It is critical for schools, and/or any parent organizations that may exist, to include stewardship in their yearly budgets. Depending on needs, this budget can be anywhere from \$1000 to \$5000 and should be determined via a site walk and discussion with key stakeholders. Stewardship budgets should also include funds for any issues that may arise, such as:

- Irrigation repairs
- Fallen trees or broken branches
- Damaged tools or infrastructure
- Extra supplies
- New or updated infrastructure and materials
- Replacement of vandalized items
- General wear and tear

## 7. STEWARDSHIP AT A GLANCE

School communities inevitably face turnover and change. It is therefore important to be as organized as possible about your living schoolyard's history, stakeholders, routines, and successes and challenges. School sites should:

1. Record an oral history of the living schoolyard project (or write one down)
2. Use the forms that OUSD has created to ensure yearly maintenance plans are in place
3. Keep tools and materials tidy and labeled so that inventory is updated easily
4. Keep an updated list of key contacts, stakeholders, and roles involved in the project

Train teachers and students in ongoing stewardship tasks, and build a culture of stewardship throughout the school

# Appendices

APPENDIX A: STANDARD DETAILS

APPENDIX B: TREE LIST

APPENDIX C: PLANT LIST

APPENDIX D: MAINTENANCE AND  
STEWARDSHIP RESOURCES

APPENDIX E: LIVING SCHOOLYARDS:  
THE WHY



05

## APPENDIX A

### Standard Details

Appendix A contains technical design details for reference in the implementation of the components of a living schoolyard. Each detail contains Designer Notes, Construction Notes, and Maintenance Notes that serve to describe key factors when installing a given feature of the living schoolyard. Further discussion around each feature can be found in Chapter 2: DESIGN COMPONENTS. As of the date published, these details comply with applicable codes. Prior to using in your project, a comprehensive review for code compliance as well as further detailing as necessary for the particular site or application would be required.

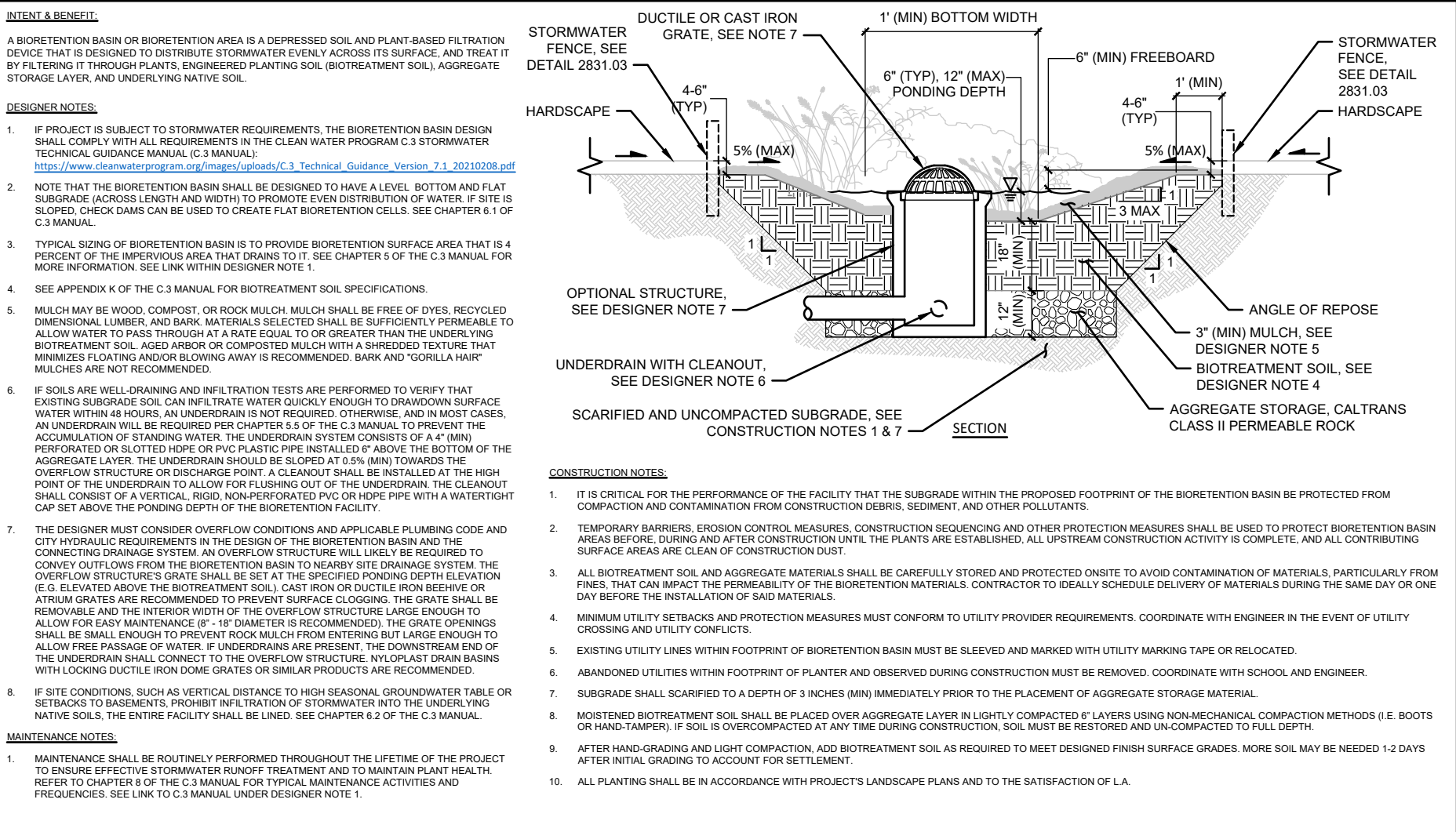

NOT FOR CONSTRUCTION

THIS DETAIL MAY NOT BE APPLICABLE IN ALL CIRCUMSTANCES AND IS PROVIDED FOR INFORMATIONAL PURPOSES ONLY. SPECIFIC SITE CONDITIONS AND SCHOOL/COMMUNITY REQUIREMENTS MUST BE TAKEN INTO CONSIDERATION. COPYRIGHT RETAINED JOINTLY BY THE OAKLAND UNIFIED SCHOOL DISTRICT AND TRUST FOR PUBLIC LAND. THIS DETAIL IS NOT TO BE REPRODUCED WITHOUT PERMISSION.

OAKLAND UNIFIED SCHOOL DISTRICT TRUST FOR PUBLIC LAND	BAY TREE DESIGN Lotus Water engineering	LIVING SCHOOL GROUND STANDARD DETAILS	DATE: OCTOBER 2022	NOT TO SCALE	DETAIL #
			BIORETENTION SCHOOL GROUND PLANTER		



**INTENT & BENEFITS:**

RAINWATER CISTERNS COLLECT RAINWATER FROM ROOFS AND TEMPORARILY STORE THE WATER BEFORE IT IS USED TO MEET NON-POTABLE DEMANDS, SUCH AS IRRIGATION. THIS DETAIL PROVIDES GUIDANCE IN THE DESIGN AND INSTALLATION OF A SIMPLE DEMONSTRATION RAINWATER HARVESTING SYSTEM THAT REDIRECTS ROOF RUNOFF TO AN ABOVE-GROUND CISTERN. THE STORED WATER CAN BE USED TO MANUALLY IRRIGATE ONSITE PLANTED AREAS. THIS DETAIL DOES NOT COVER MORE COMPLEX WATER REUSE SYSTEMS THAT INVOLVE GRAYWATER, BLACKWATER OR STORMWATER, USE STORED WATER TO MEET NON-IRRIGATION DEMANDS, ARE PART OF A LARGER PROJECT'S STORMWATER MANAGEMENT REQUIREMENT COMPLIANCE PLAN, INCLUDE A MUNICIPAL WATER MAKEUP CONNECTION AND/OR REQUIRE BUILDING PERMITS.

**RAINWATER CISTERN DESIGNER NOTES:**

1. THE DESIGN AND SIZING OF THE RAINWATER SYSTEM SHALL BE IN ACCORDANCE WITH THE CHAPTER 17 "NONPOTABLE RAINWATER CATCHMENT SYSTEMS" OF THE CALIFORNIA PLUMBING CODE: [www.iapmo.org/Pages/2013CaliforniaPlumbingCode.aspx](http://www.iapmo.org/Pages/2013CaliforniaPlumbingCode.aspx)
2. RAINWATER SHALL NOT BE COLLECTED FROM ROOFS CONTAINING ANY OF THE FOLLOWING: COPPER OR GALVANIZED METAL THAT HAS NOT BEEN TREATED TO REMOVE ZINC, UNTREATED ZINC COATINGS, FUNGICIDES-, HERBICIDES-, OR BIOCIDES-TREATED SURFACES, ASBESTOS PRODUCTS, OR ANY LEAD PRODUCTS. THE OVERFLOW PIPE SHALL BE KEPT OUT OF THE PATH OF TRAVEL. CONTRACTOR AND/OR HOMEOWNER MAY CHOOSE TO INCLUDE A BOX AROUND THE OVERFLOW PIPE TO PREVENT DAMAGE/TRIPPING HAZARDS.
3. CISTERN LOCATION CONSIDERATIONS:
  - 3.A. LOCATE CISTERNS SO AS TO NOT OBSTRUCT ACCESS TO WALKWAYS, DOORWAYS, WINDOWS OR OTHER REGULARLY ACCESSED PATHS OR FEATURES.
  - 3.B. CISTERNS SHOULD BE SETBACK 1'-2' FROM ADJACENT BUILDINGS OR STRUCTURES. ADDITIONAL SETBACKS FROM UTILITY INFRASTRUCTURE, E.G. ELECTRICAL CABINETS AND UTILITY POLES ARE REQUIRED AND SHOULD BE VERIFIED WITH THE UTILITY PROVIDER.
  - 3.C. CISTERN LOCATION SHALL ALLOW FOR INSPECTION AND MAINTENANCE, INCLUDING OVERHEAD ACCESS TO AT LEAST ONE ACCESS OPENING THAT CAN BE LOCKED TO PREVENT UNAUTHORIZED ACCESS.
  - 3.D. THE HEIGHT OF THE CISTERN SHALL BE 6' TALL (MAX) AND ALLOW ENOUGH VERTICAL SPACE BETWEEN THE TOP OF THE CONNECTING DOWNSPOUT AND THE CISTERN INLET TO INSTALL THE DEBRIS FILTER AND FIRST FLUSH DIVERTER.
  - 3.E. DO NOT LOCATE CISTERNS WHERE THEY CAN EASILY BE CLIMBED ON AND/OR PRESENT OTHER SAFETY CONCERNS.
4. PLASTIC CISTERNS MUST BE OPAQUE, U.V. STABILIZED, NON-COLLAPSIBLE AND WATER TIGHT. TANKS SHALL BE NSF AND FDA COMPLIANT.
5. GOOD PRE-TREATMENT WILL SIGNIFICANTLY REDUCE THE REQUIRED FREQUENCY OF CISTERN CLEANING AND PREVENT CLOGGING OF THE SYSTEM. RAINWATER SHALL BE PRE-TREATED PRIOR TO ENTRY INTO THE CISTERN BY PROVIDING THE FOLLOWING, STARTING AT THE ROOF GUTTER:
  - 5.A. LEAF SCREEN WITHIN THE GUTTER THAT PREVENTS LARGER DEBRIS FROM ENTERING THE DOWNSPOUT. LEAF SCREEN SHALL BE EASY TO CLEAN OUT.
  - 5.B. DEBRIS FILTER CONNECTED TO THE DOWNSPOUT. THE SIZE AND TYPE OF THE DEBRIS FILTER SHALL CONSIDER THE ROOF CATCHMENT AREA AND EASE OF MAINTENANCE.
  - 5.C. FIRST FLUSH DIVERTER, AND/OR AN EQUIVALENT PRE-TREATMENT DEVICE. SIMPLE FLOATING BALL TYPE FIRST FLUSH DIVERTERS ARE RECOMMENDED OVER MORE COMPLICATED DESIGNS.
6. A CALMING INLET SHALL BE INSTALLED AT THE END OF THE TANK INLET PIPE TO PREVENT INCOMING WATER FROM DISTURBING SEDIMENT AND TO INTRODUCE OXYGEN AT THE BOTTOM OF THE TANK.

7. AN AIR VENT WITH A MESH SCREEN HAVING HOLES LESS THAN 1 MILLIMETER SHALL BE PROVIDED ON THE TANK TO PREVENT MOSQUITOS FROM ENTERING WHILE ALLOWING AIR FLOW.
8. AN OVERFLOW OUTLET PIPE THAT CONNECTS TO THE EXISTING STORM DRAIN SYSTEM OR AN APPROVED LANDSCAPED AREA. IF HARD-PIPED TO A STORM DRAIN SYSTEM, THE AGENCY HAVING JURISDICTION MAY REQUIRE AN AIR GAP (TYPICALLY MEASURING 2X AS TALL AS THE DIAMETER OF THE PIPE) TO PREVENT BACKFLOW INTO THE CISTERN. IF DISCHARGED ABOVE-GRADE TO A LANDSCAPED AREA, A SCREEN AT THE END OF THE PIPE IS REQUIRED TO PREVENT RODENTS AND INSECTS FROM ENTERING PIPE.
9. THE OVERFLOW PIPE SHALL BE KEPT OUT OF THE PATH OF TRAVEL. DESIGNER MAY CHOOSE TO INCLUDE A BOX AROUND THE OVERFLOW PIPE TO PREVENT DAMAGE/TRIPPING HAZARDS.
10. THE DESIGNER MAY CHOOSE TO PLUMB THE CISTERN OUTLET PIPE TO A WATERING STATION CONSTRUCTED FROM A SUPPORT POST AND HOSE BIB STANDPIPE OR A MANUAL HAND-CRAKE PUMP. CAREFUL CONSIDERATION SHALL BE MADE TO PREVENT UNSUPERVISED USE OF THE RAINWATER, I.E. LOCKING UP OF THE OUTLET CONTROLS.
11. THE RAINWATER CISTERN SYSTEM MUST NOT BE DIRECTLY CONNECTED TO THE POTABLE WATER SYSTEM AT ANY TIME.

**RAINWATER CISTERN CONSTRUCTION NOTES:**

1. CISTERNS SHALL BE PLACED ON A STABLE AND LEVEL PAD (COMPACTED GRAVEL PAD WITH PERIMETER EDGING OR CONCRETE SLAB IN ACCORDANCE WITH TANK MANUFACTURER'S RECOMMENDATIONS) AND ADEQUATELY SECURED TO AN ADJACENT WALL WITH METAL ANCHORING STRAPS OR SOMETHING SIMILAR TO PROVIDE SEISMIC SAFETY. CISTERNS OVER 5,000 GALLONS REQUIRE A LICENSED ENGINEER TO PREPARE THE SYSTEM AND OBTAIN A BUILDING PERMIT.
2. ALL CISTERN CONNECTIONS SHALL BE WATER TIGHT.
3. THE OVERFLOW PIPE DIAMETER SHALL MATCH THE DIAMETER OF THE ORIGINAL DOWNSPOUT/RAINWATER LEADER LINE.
4. THE OVERFLOW PIPE SHALL BE COLOR CODED AND LABELED AS "RAINWATER, NOT FOR CONSUMPTION."
5. ALL CONNECTING HOSE BIBS SHALL BE LABELED AS "RAINWATER, NOT FOR CONSUMPTION."
6. ALL PIPING SHALL BE LEAD FREE.
7. THE "TRUTH TUBE" LEVEL GAUGE MEASURES THE VOLUME OF RAINWATER COLLECTED WITHIN THE CISTERN. THE LEVEL GAUGE SHALL BE INSTALLED ON THE OUTSIDE OF THE CISTERN AND PLUMBED TO THE CISTERN VIA MISALIGNMENT UNIONS AT THE TOP AND BOTTOM OF THE LEVEL GAUGE WITH ATTACHED INTEGRAL VALVES TO CONTROL GAUGE PRESSURE. THE TOP OF THE LEVEL GAUGE SHALL EXTEND AT MINIMUM ABOVE THE CISTERN MAXIMUM DEPTH LINE.

**MAINTENANCE NOTES:**

1. RAINWATER CISTERN SYSTEMS REQUIRE DILIGENT AND ROUTINE MAINTENANCE BY INFORMED STAFF TO PREVENT BLOCKAGES AND MAINTAIN GOOD WATER QUALITY.
2. AN OPERATION AND MAINTENANCE (O&M) PLAN MUST BE DEVELOPED PRIOR TO THE START OF THE OPERATION OF THE SYSTEM AND SHOULD BE STORED IN A SAFE LOCATION NEAR THE CISTERN. GUIDELINES FOR PREPARING THE O&M PLAN CAN BE FOUND IN CHAPTER 8 OF THE CLEAN WATER PROGRAM C.3 STORMWATER TECHNICAL GUIDANCE MANUAL (C.3 MANUAL): [https://www.cleanwaterprogram.org/images/uploads/C.3\\_Technical\\_Guidance\\_Version\\_7.1\\_20210208.pdf](https://www.cleanwaterprogram.org/images/uploads/C.3_Technical_Guidance_Version_7.1_20210208.pdf)
3. ADDITIONAL O&M GUIDANCE, INCLUDING A SUMMARY TABLE OF RECOMMENDED MAINTENANCE ACTIVITIES AND SCHEDULE, CAN BE FOUND IN THE SAN FRANCISCO RAINWATER HARVESTING MANUAL: [https://sfpc.org/sites/default/files/learning/RWH\\_Manual\\_Final-APR2018.pdf](https://sfpc.org/sites/default/files/learning/RWH_Manual_Final-APR2018.pdf)

© THIS DETAIL MAY NOT BE APPLICABLE IN ALL CIRCUMSTANCES AND IS PROVIDED FOR INFORMATIONAL PURPOSES ONLY. SPECIFIC SITE CONDITIONS AND SCHOOL/COMMUNITY REQUIREMENTS MUST BE TAKEN INTO CONSIDERATION. COPYRIGHT RETAINED JOINTLY BY THE OAKLAND UNIFIED SCHOOL DISTRICT AND TRUST FOR PUBLIC LAND. THIS DETAIL IS NOT TO BE REPRODUCED WITHOUT PERMISSION.

 <p>OAKLAND UNIFIED SCHOOL DISTRICT Community Schools, Thriving Students</p>	 <p>BAY TREE DESIGN</p>	<p>LIVING SCHOOL GROUND STANDARD DETAILS</p>	DATE: OCTOBER 2022	NOT TO SCALE	DETAIL #
			<p>DEMONSTRATION</p> <p>RAINWATER CISTERN - NOTES</p>		2300.02A
 <p>TRUST FOR PUBLIC LAND</p>	 <p>Lotus Water engineering</p>				

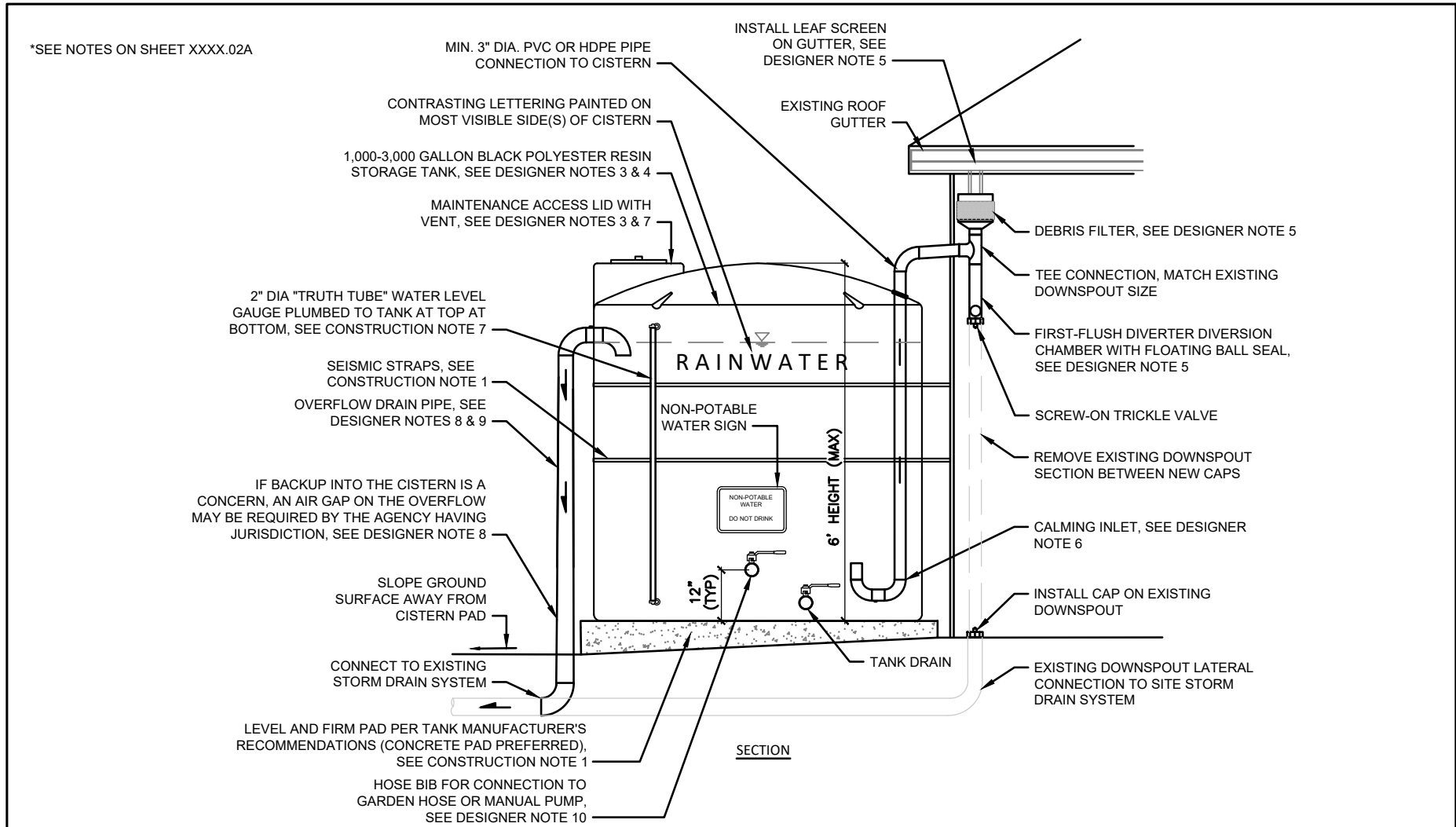

NOT FOR CONSTRUCTION

© THIS DETAIL MAY NOT BE APPLICABLE IN ALL CIRCUMSTANCES AND IS PROVIDED FOR INFORMATIONAL PURPOSES ONLY. SPECIFIC SITE CONDITIONS AND SCHOOL/COMMUNITY REQUIREMENTS MUST BE TAKEN INTO CONSIDERATION. COPYRIGHT RETAINED JOINTLY BY THE OAKLAND UNIFIED SCHOOL DISTRICT AND TRUST FOR PUBLIC LAND. THIS DETAIL IS NOT TO BE REPRODUCED WITHOUT PERMISSION.

OAKLAND UNIFIED SCHOOL DISTRICT Community Schools. Working Students.	BAY TREE DESIGN	LIVING SCHOOL GROUND STANDARD DETAILS	DATE: OCTOBER 2022	NOT TO SCALE	DETAIL #
			DEMONSTRATION RAINWATER CISTERN - DETAIL		
TRUST FOR PUBLIC LAND™	Lotus Water engineering				

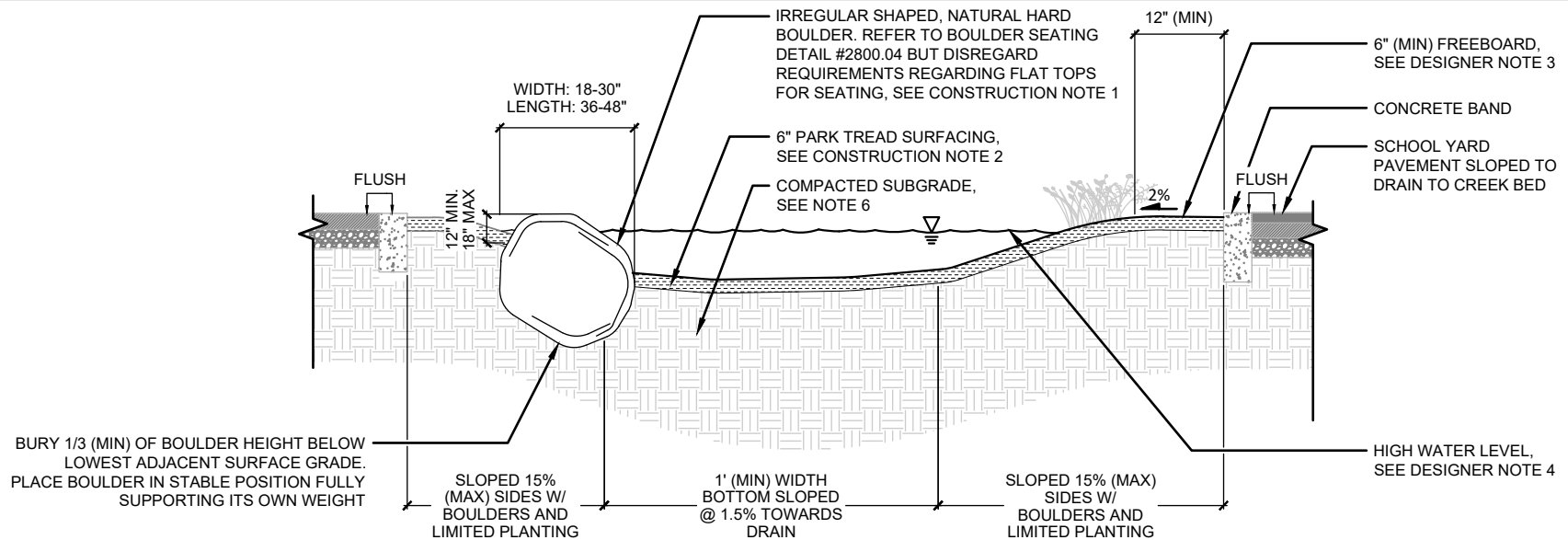

NOT FOR CONSTRUCTION

**INTENT & BENEFIT:**

A DRY CREEK BED IS A WIDE DRAINAGE SWALE THAT COLLECTS RUNOFF FROM ADJACENT PAVED SURFACES AND CONVEYS THE STORMWATER TO A STANDARD DRAINAGE STRUCTURE AT ITS LOW END OR A STORMWATER MANAGEMENT FACILITY, SUCH AS A BIORETENTION BASIN, THAT TREATS THE RUNOFF PRIOR TO IT LEAVING THE SITE. THIS DESIGN VERSION SHOWS A COMPLETELY PAVED CREEK BED TO ADDRESS SAFETY AND SECURITY CONCERNS, SO VERY LITTLE INFILTRATION OF STORMWATER WILL OCCUR WITHIN THE CREEK BED.

**DESIGNER NOTES:**

1. THE LAYOUT AND GRADING DESIGN OF DRY CREEK BED NEEDS TO BE THOUGHTFULLY TAILORED TO EACH SITE'S SPECIFIC SITE AND DRAINAGE CONDITIONS.
2. THE DRY CREEK BED DESIGN ELEMENT AS SHOWN DOES NOT PROVIDE ANY STORMWATER TREATMENT OR RETENTION/DETENTION BENEFITS. HOWEVER, THE CREEK BED CAN BE DESIGNED TO DIRECT RUNOFF TO A BIORETENTION BASIN (SEE DETAIL 1.00) WHICH CAN PROVIDE AN OPPORTUNITY FOR THE CAPTURED STORMWATER TO INFILTRATE THROUGH ENGINEERED BIOTREATMENT SOIL AND INTO THE UNDERLYING SITE SOIL. IF A BIORETENTION BASIN IS PROVIDED AT THE DOWNGRADIENT END OF THE DRY CREEK BED, A RAISED OVERFLOW STRUCTURE SHALL BE PROVIDED. IF THE DRY CREEK BED IS NOT CONNECTED TO A BIORETENTION BASIN, A STANDARD DRAINAGE STRUCTURE SHALL BE PROVIDED AT THE LOW POINT.
3. THE DRY CREEK BED SHALL BE SIZED TO CONVEY THE DESIGN FLOW RATE PRESCRIBED BY THE AUTHORITY HAVING JURISDICTION AND THE OVERALL SITE DRAINAGE DESIGN SHALL INCLUDE CONSIDERATIONS (E.G., OVERLAND FLOW RELEASE, BACKUP DRAIN INLET) FOR A CLOGGED DRAINAGE STRUCTURE WITHIN THE CREEK BED.
4. IF THE DRY CREEK BED CONNECTS TO A BIORETENTION BASIN OR OTHER STORMWATER FEATURE THAT ALLOWS FOR TEMPORARY PONDING OF WATER 24 HOURS (MAX) FOLLOWING A RAIN EVENT, THE MAXIMUM DEPTH OF WATER SHALL NOT EXCEED 12"; THE PREFERRED PONDING DEPTH IS 6". IF THE CREEK BED CONVEYS STORMWATER TO A STANDARD DRAINAGE STRUCTURE, THERE SHOULD NOT BE ANY PONDING OF WATER.

**CONSTRUCTION NOTES:**

1. FINAL SPACING AND INSTALLATION OF BOULDERS AND PLANTS TO BE TO THE SATISFACTION OF THE LANDSCAPE ARCHITECT AND/OR OUSD PROJECT MANAGER. IF PLANTS ARE INCORPORATED IN THE DESIGN, THEY SHALL BE LOCATED WITHIN THE SLOPED SIDES ONLY AND ABOVE THE WATER LEVEL. SUITABLE OPENINGS WITHIN THE PARK TREAD MATERIAL SHOULD BE PROVIDED TO ALLOW FOR THE PLANT ROOTS TO GET ADEQUATE WATER AND AIR.
2. COMPACTED SUBGRADE BELOW PARK TREAD SURFACING SHOULD BE COMPACTED TO A MINIMUM OF 90% RELATIVE COMPACTION. BASE ROCK IS NOT REQUIRED BENEATH COMPACTED SUBGRADE UNLESS NATIVE SOILS HAVE A HIGH AMOUNT OF CLAY OR CANNOT MEET THE 90% COMPACTION TESTING CRITERIA.

**MAINTENANCE NOTES:**

1. PARK TREAD SURFACING IS A LOW MAINTENANCE PAVEMENT MATERIAL AND DUE TO ITS NATURAL BINDING AGENTS, IT SHOULD NOT PRODUCE LOOSE AGGREGATE AND SEDIMENT THAT NEEDS TO BE FREQUENTLY REMOVED FROM ADJACENT PAVEMENT SURFACES AND/OR WITHIN DOWNSTREAM DRAINAGE ELEMENTS. IF REPAIR AND/OR MAINTENANCE IS REQUIRED, IT SHOULD BE PERFORMED IN ACCORDANCE TO THE MANUFACTURER'S RECOMMENDATIONS: <http://www.parktread.com/contact/>
2. TRASH AND DEBRIS SHALL BE ROUTINELY REMOVED FROM THE CREEK BED TO MAINTAIN THE CAPACITY OF THE CONVEYANCE MEASURE AND PREVENT DEBRIS FROM CLOGGING DOWNSTREAM DRAINAGE ELEMENTS.

© THIS DETAIL MAY NOT BE APPLICABLE IN ALL CIRCUMSTANCES AND IS PROVIDED FOR INFORMATIONAL PURPOSES ONLY. SPECIFIC SITE CONDITIONS AND SCHOOL/COMMUNITY REQUIREMENTS MUST BE TAKEN INTO CONSIDERATION. COPYRIGHT RETAINED JOINTLY BY THE OAKLAND UNIFIED SCHOOL DISTRICT AND TRUST FOR PUBLIC LAND. THIS DETAIL IS NOT TO BE REPRODUCED WITHOUT PERMISSION.

OAKLAND UNIFIED SCHOOL DISTRICT Community Schools, Thinking Students	BAY TREE DESIGN	LIVING SCHOOL GROUND STANDARD DETAILS	DATE: OCTOBER 2022	NOT TO SCALE	DETAIL #
			<h1>DRY CREEK BED</h1>		<h1>2300.03</h1>
TRUST FOR PUBLIC LAND™	Lotus Water engineering				

**INTENT & BENEFIT:**

A CONCRETE HEADER WILL PROTECT EXISTING ASPHALT AT EDGES WHEN RENOVATING ADJACENT ASPHALT PAVING FOR LIVING SCHOOLYARD IMPROVEMENTS.

**DESIGN NOTES:**

1. PROVIDE DISTINCT AREAS FOR ENTRY AND EXIT TO AREAS WITH LOOSE MATERIAL SURFACING WITH A WIDE THRESHOLD MATERIAL THAT CAN BE EASILY MAINTAINED SUCH AS A CONCRETE PATH, SAND BOX EDGING WITH TRANSFER PLATFORM FOR THOSE USING A WHEELCHAIR, OR A WOODEN BRIDGE.
2. PROVIDE A DIVIDER TO KEEP PEDESTRIAN TRAFFIC FROM FLOWING OUT OF THE LOOSE MATERIAL SURFACING AREA AT SPOTS OTHER THAN THE ENTRANCE/EXIT. DIVIDERS MAY BE A FENCE, PLANTING AREA, TOPOGRAPHY CHANGE, CURB, OR EMBEDDED LOG. IF THE DIVIDER BETWEEN LOOSE MATERIALS AND HARDSCAPE IS A FENCE, ALSO INCLUDE A CURB OR LINED-UP LOGS TO CONTAIN FLOW OF LOOSE MATERIALS UNDER THE FENCE.

**CONSTRUCTION NOTES:**

1. CERTAIN DIMENSIONS AND SPECIFICATIONS RELIANT UPON INPUT FROM CIVIL ENGINEER AND GEOTECH REPORT ON EXISTING SOIL CONDITIONS.
2. WHERE ASPHALT IS CUT CLEANLY WITHOUT CRUMBLING OF ADJACENT CONDITION, CONCRETE CURB MAY BE FORMED DIRECTLY AGAINST ADJACENT ASPHALT. WHERE CRUMBLING OCCURS, ASPHALT IS TO BE OVERCUT TO ALLOW FOR FORMWORK AND PATCHED.
3. FOR CONCRETE CURB, PLACE SCORE JOINTS 12' O.C. MAX.
4. FOR CONCRETE CURB, PLACE EXPANSION JOINTS 24' O.C. MAX.
5. PER OUSD VEGETATION POLICY (P.5), SCHOOL SITES MAY ACCEPT DONATIONS OF LOCALLY CHIPPED TREE PRUNINGS OR WOOD CHIPS FROM TREE TRIMMINGS OR OTHER APPROVED VENDORS INDICATED ON THE OUSD SCHOOL GARDEN COUNCIL'S VENDOR LIST. WOOD CHIPS MAY NOT BE ACCEPTED FROM UNAPPROVED SOURCES AS THE MATERIAL MAY CONTAIN INVASIVE PLANTS, DISEASE OR PESTS.
6. INSTALL TO THE SATISFACTION OF THE LANDSCAPE ARCHITECT AND/OR OUSD FACILITIES.

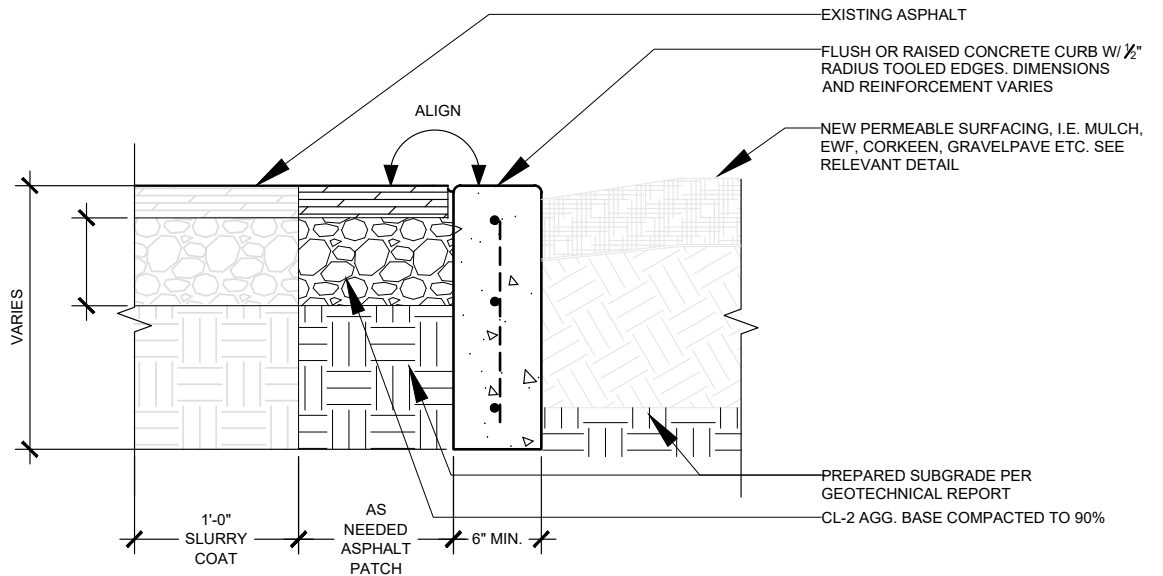

NOT FOR CONSTRUCTION

© THIS DETAIL MAY NOT BE APPLICABLE IN ALL CIRCUMSTANCES AND IS PROVIDED FOR INFORMATIONAL PURPOSES ONLY. SPECIFIC SITE CONDITIONS AND SCHOOL/COMMUNITY REQUIREMENTS MUST BE TAKEN INTO CONSIDERATION. COPYRIGHT RETAINED JOINTLY BY THE OAKLAND UNIFIED SCHOOL DISTRICT AND TRUST FOR PUBLIC LAND. THIS DETAIL IS NOT TO BE REPRODUCED WITHOUT PERMISSION.

		OUSD LIVING SCHOOLYARD STANDARD DETAILS	DATE: OCTOBER 2022	NOT TO SCALE	DETAIL #
			<b>FLUSH CONCRETE HEADER AT CUT ASPHALT EDGE</b>		

**INTENT & BENEFIT:**

PERMEABLE PAVERS PROVIDE MORE AREA FOR STORMWATER INFILTRATION ON-SITE. ADDITIONALLY, PAVERS ALLOW AN OPPORTUNITY FOR ADDED COLOR, TEXTURE, AND INTEREST FOR SPECIAL PAVING AREAS.

**DESIGN NOTES:**

1. PERMEABLE PAVERS CAN BE USED FOR ADA AND VEHICULAR ACCESS.
2. LOCATE LOOSE MATERIAL GROUND SURFACING AWAY FROM BUILDINGS, HIGH TRAFFIC AREAS, AND ACTIVE AREAS SUCH AS BALL PLAY.
3. CHOOSE PRODUCTS THAT DO NOT REQUIRE ANNUAL STEAMING OR POWER WASHING TO KEEP MAINTENANCE REQUIREMENTS LOW.
4. EACH UNIT PAVER SHOULD BE TOO HEAVY TO BE LIFTED BY STUDENTS.
5. SELECT LIGHT-COLORED / HIGH-ALBEDO MATERIALS WITH SOLAR REFLECTANCE INDEX OF AT LEAST 0.29
6. ALL WALKING SURFACES MUST HAVE A RUNNING SLOPE < 1:20 AND A CROSS-SLOPE < 1:48.

**CONSTRUCTION NOTES:**

1. CERTAIN DIMENSIONS AND SPECIFICATIONS RELIANT UPON INPUT FROM CIVIL ENGINEER AND GEOTECH REPORT ON EXISTING SOIL CONDITIONS.
2. VERIFY LOCATION OF UNDERGROUND UTILITIES, FACILITIES AND TREE ROOTS IN THE AREA.
3. GAP BETWEEN PAVERS NO GREATER THAN 1/4" TO MAINTAIN ADA ACCESSIBILITY.
4. VERIFY THAT SUBGRADE DRAINAGE IS INSTALLED AT PROPER ELEVATIONS AND THAT SMOOTH GRADING IS COMPLETE.
5. CORRECT SUBGRADE IRREGULARITIES TO ENSURE THAT SUBGRADE ELEVATION IS IN ACCORDANCE WITH MANUFACTURER'S REQUIREMENTS AND TO ENSURE POSITIVE DRAINAGE.
6. REMOVE ROCKS, DEBRIS, AND OTHER SIMILAR ITEMS.
7. WHERE ASPHALT IS CUT CLEANLY WITHOUT CRUMBLING OF ADJACENT CONDITION, CONCRETE CURB MAY BE FORMED DIRECTLY AGAINST ADJACENT ASPHALT. WHERE CRUMBLING OCCURS, ASPHALT IS TO BE OVERCUT TO ALLOW FOR FORMWORK AND PATCHED.
8. INSTALL TO THE SATISFACTION OF THE LANDSCAPE ARCHITECT AND/OR OUSD FACILITIES.

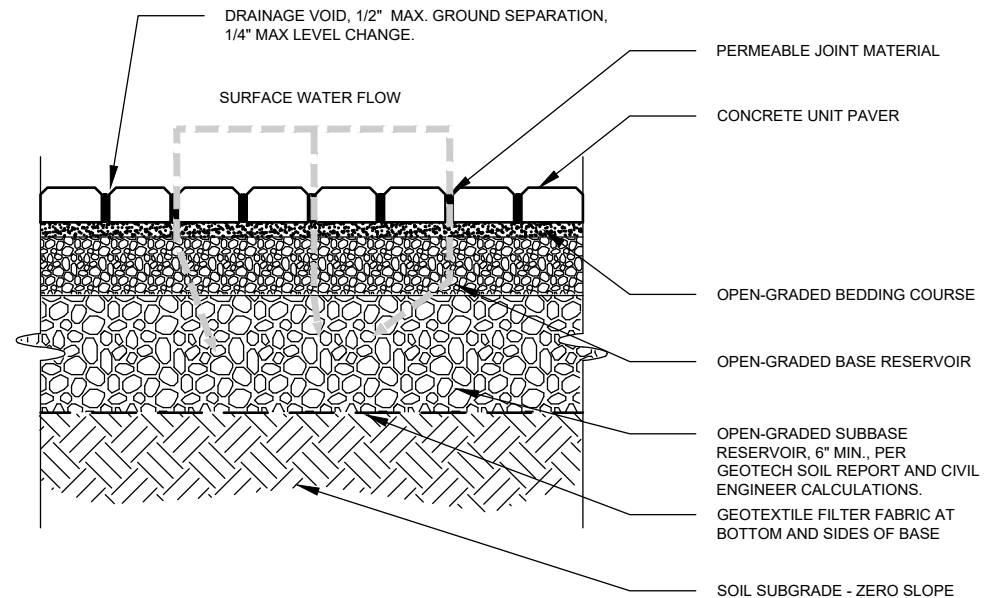

**MAINTENANCE NOTES:**

1. PERMEABLE PAVERS REQUIRE LITTLE MAINTENANCE.



NOT FOR CONSTRUCTION

© THIS DETAIL MAY NOT BE APPLICABLE IN ALL CIRCUMSTANCES AND IS PROVIDED FOR INFORMATIONAL PURPOSES ONLY. SPECIFIC SITE CONDITIONS AND SCHOOL/COMMUNITY REQUIREMENTS MUST BE TAKEN INTO CONSIDERATION. COPYRIGHT RETAINED JOINTLY BY THE OAKLAND UNIFIED SCHOOL DISTRICT AND TRUST FOR PUBLIC LAND. THIS DETAIL IS NOT TO BE REPRODUCED WITHOUT PERMISSION.

 <p>OAKLAND UNIFIED SCHOOL DISTRICT Community Schools. Thriving Students.</p>	 <p>BAY TREE DESIGN</p>	<p>OUSD LIVING SCHOOLYARD STANDARD DETAILS</p>	DATE: OCTOBER 2022	NOT TO SCALE	DETAIL #
			<p><b>PERMEABLE PAVERS FULL FILTRATION</b></p>		2730.02

**INTENT & BENEFIT:**

GRAVELPAVE2 PROVIDES A LOW-MAINTENANCE PERMEABLE SURFACE WITH A HIGH COMPRESSIVE STRENGTH, ALLOWING FOR ADA AND VEHICULAR ACCESS.

**DESIGN NOTES:**

1. GRAVELPAVE CAN BE USED IN AREAS NOT DESIGNED FOR ACTIVE PLAY AND WHERE CHILDREN WILL BE CLOSELY SUPERVISED SUCH AS OUTDOOR LEARNING ENVIRONMENTS.
2. SPECIFY GRAVEL COLORS THAT MEET CHPS SRI VALUES.
3. LIMIT MIGRATION OF GRAVEL BY INSTALLING IN AREAS BELOW SURROUNDING GRADE OR WITH BARRIERS SUCH AS CONCRETE CURBS OR WALLS. CREATE DISTINCT ENTRANCE POINTS TO WOOD GRAVEL AREAS WITH A THRESHOLD (CONCRETE, ASPHALT, WOOD DECKING, ...) TO FURTHER LIMIT MIGRATION OF MATERIAL.

**CONSTRUCTION NOTES:**

1. CERTAIN DIMENSIONS AND SPECIFICATIONS RELIANT UPON INPUT FROM CIVIL ENGINEER AND GEOTECH REPORT ON EXISTING SOIL CONDITIONS.
2. GRAVELPAVE2 SPECIFICATIONS:  
 UNIT SIZE: 20" X 20" X 1" OR 40" X 40" X 1"  
 AVAILABLE IN 9 STANDARD ROLL SIZES  
 UNIT WEIGHT: 19 OZ. OR 4.8 LB.  
 STRENGTH: 15,940 PSI  
 COMPOSITION: 100% RECYCLED HIGH DENSITY POLYETHYLENE
3. DO NOT BEGIN INSTALLATION OF POROUS PAVEMENTS UNTIL ALL HARD SURFACE PAVING ADJACENT TO POROUS PAVEMENT AREAS IS COMPLETED.
4. INSTALL GRAVELPAVE2 UNITS WHEN AMBIENT AIR TEMP. IS AT LEAST 55 DEGREES F.
5. DO NOT DRIVE ON, PARK ON, OR USE GRAVELPAVE2 SYSTEM UNTIL SYSTEM HAS BEEN PROPERLY ANCHORED AND FULLY FILLED WITH GRAVEL AGGREGATE FILL.
6. OBTAIN CLEAN, WASHED, FINE DECORATIVE GRAVEL, MUST BE SHARP AND ANGULAR (NOT ROUNDED) STONE, GRANITE HARDNESS, NOT TO BE OVERFILLED MORE THAN 1/4".
7. TYPICAL ANCHORS SHALL BE 8" LONG GALVANIZED NAILS WITH "FENDER" TYPE WASHERS.
8. OPTIONAL: TREE RESIN BINDERS MAY BE ADDED FOR ADDITIONAL AGGREGATE STABILIZATION, HOWEVER BINDERS WILL REDUCE POROSITY.
9. INSTALLATION TO BE TO THE SATISFACTION OF THE LANDSCAPE ARCHITECT AND/OR OUSD FACILITIES.

**MAINTENANCE NOTES:**

1. GRAVEL WILL NEED TO BE RAKED PERIODICALLY TO MAINTAIN ADA ACCESSIBILITY.
2. GRAVEL MAY NEED TO BE TOPPED OFF EVERY 10-15 YEARS DEPENDING ON INTENSITY OF USE.

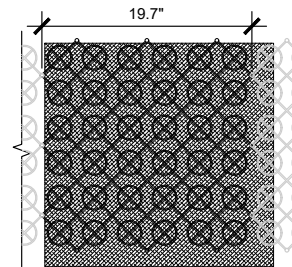

PLAN



GRAVELPAVE2 DURING INSTALLATION

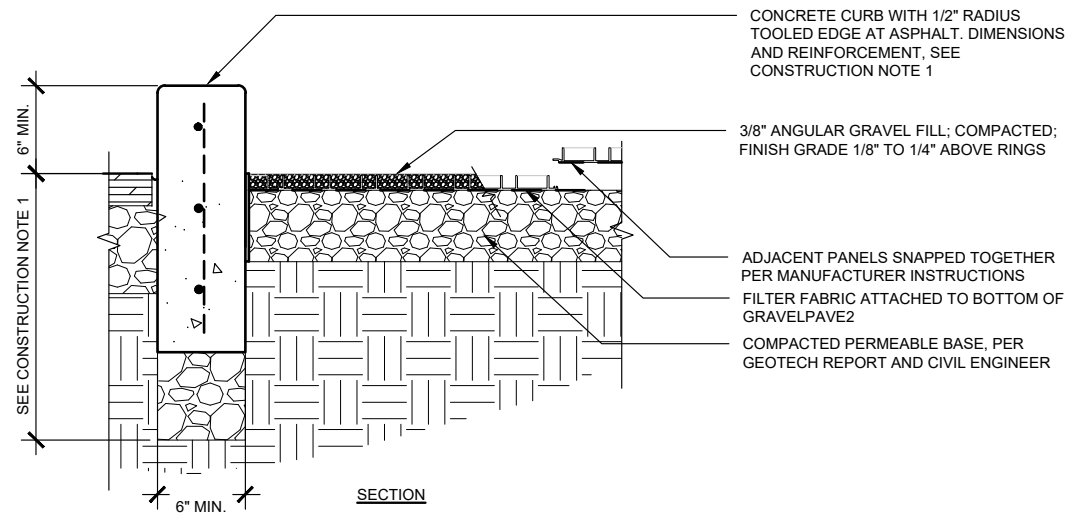

NOT FOR CONSTRUCTION



THIS DETAIL MAY NOT BE APPLICABLE IN ALL CIRCUMSTANCES AND IS PROVIDED FOR INFORMATIONAL PURPOSES ONLY. SPECIFIC SITE CONDITIONS AND SCHOOL/COMMUNITY REQUIREMENTS MUST BE TAKEN INTO CONSIDERATION. COPYRIGHT RETAINED JOINTLY BY THE OAKLAND UNIFIED SCHOOL DISTRICT AND TRUST FOR PUBLIC LAND. THIS DETAIL IS NOT TO BE REPRODUCED WITHOUT PERMISSION.



**BAY TREE DESIGN**

OUSD LIVING  
SCHOOLYARD  
STANDARD  
DETAILS

DATE: OCTOBER 2022

NOT TO SCALE

DETAIL #



**GRAVELPAVE2**

**2730.03**

**INTENT & BENEFIT:**

DECOMPOSED GRANITE (DG) PROVIDES AN ADA ACCESSIBLE, INEXPENSIVE, NATURAL, SEMI-PERMEABLE SURFACING OPTION FOR OUTDOOR LEARNING ENVIRONMENTS, NATURE EXPLORATION AREAS, AND PATHWAYS. DG OFFERS A MORE TACTILE SURFACE AND CAN BE SPECIFIED TO MEET CHPS SRI VALUES TO LOWER AMBIENT AIR TEMPERATURES RELATIVE TO ASPHALT.

**DESIGN NOTES:**

1. LIMIT MIGRATION OF DG FINES BY INSTALLING IN AREAS BELOW SURROUNDING GRADE OR WITH BARRIERS SUCH AS FENCES, LOGS AND CONCRETE SEAT WALLS. CREATE DISTINCT ENTRANCE POINTS TO DG AREAS WITH A THRESHOLD (I.E. CONCRETE, ASPHALT, WOOD DECKING) TO FURTHER LIMIT MIGRATION OF MATERIAL.
2. DG IS A SEMI-LOOSE MATERIAL WHICH CAN CLOG STORM DRAINS. PLANTING AND GRADING SHOULD BE USED TO MINIMIZE FINES GETTING INTO NEARBY CATCH BASINS AND AREA DRAINS.
3. ALL WALKING SURFACES MUST HAVE A RUNNING SLOPE < 1:20 AND A CROSS-SLOPE <1:48.

**CONSTRUCTION NOTES:**

1. CERTAIN DIMENSIONS AND SPECIFICATIONS RELIANT UPON INPUT FROM CIVIL ENGINEER AND GEOTECH REPORT ON EXISTING SOIL CONDITIONS.
2. DO NOT INSTALL STABILIZED AGGRGATE MIX WHEN AMBIENT TEMPERATURE IS BELOW 60 DEGREES FAHRENHEIT OR OVERNIGHT TEMPERATURE IS BELOW 32 DEGREES FAHRENHEIT.
3. DO NOT INSTALL STABILIZED AGGRGATE MIX IF THE POSSIBILITY OF RAIN IS FORECAST W/IN FOUR DAYS FOLLOWING INSTALLATION.
4. INSTALLER QUALIFICATIONS: INSTALLER TO PROVIDE EVIDENCE OF AT LEAST FIVE COMPLETED JOBS TO INDICATE EXPERIENCE IN PROVIDING 1/4-INCH MINUS DECOMPOSED GRANITE PAVING CONTAINING STABILIZER BINDER ADDITIVE.
5. USE LOCAL MATERIALS.
6. WHERE ASPHALT IS CUT CLEANLY WITHOUT CRUMBLING OF ADJACENT CONDITION, CONCRETE CURB MAY BE FORMED DIRECTLY AGAINST ADJACENT ASPHALT. WHERE CRUMBLING OCCURS, ASPHALT IS TO BE OVERCUT TO ALLOW FOR FORMWORK AND PATCHED.
7. FOR CONCRETE CURB, PLACE SCORE JOINTS 12' O.C., MAX.
8. FOR CONCRETE CURB, PLACE EXPANSION JOINTS 24' O.C., MAX.
9. INSTALLATION TO BE TO THE SATISFACTION OF THE LANDSCAPE ARCHITECT AND/OR OUSD FACILITIES.

**MAINTENANCE NOTES:**

1. MAY REQUIRE PATCHING EVERY 5-10 YEARS TO ADDRESS EROSION AND WEAR, PARTICULARLY ON ADA ACCESS PATHS.
2. CONCRETE THRESHOLD WILL REQUIRE PERIODIC BROOMING.

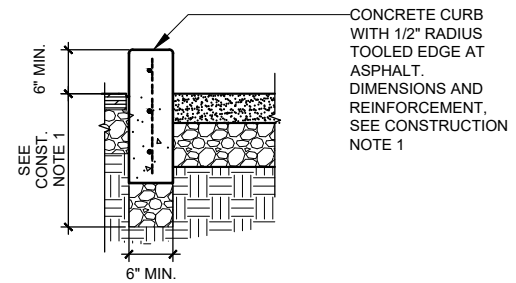

DG WITH RAISED CONCRETE CURB

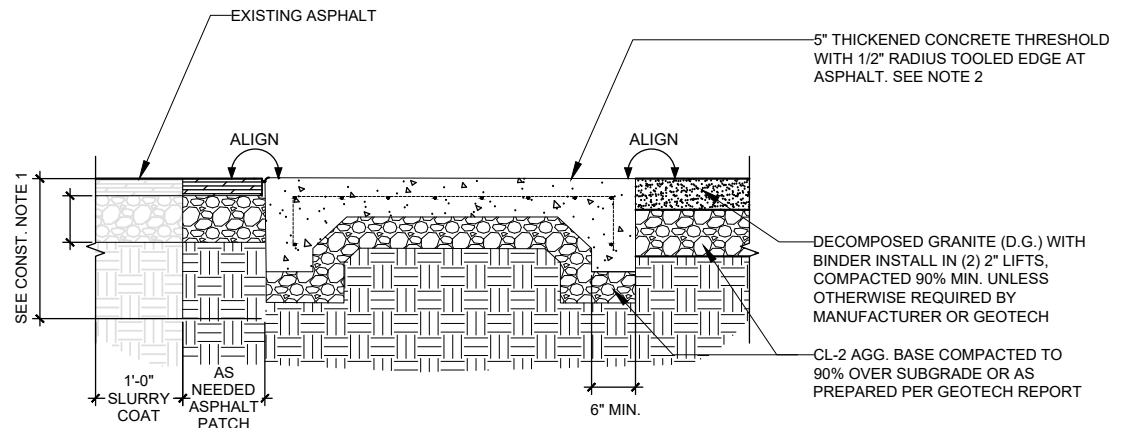

DG WITH CONCRETE THRESHOLD

NOT FOR CONSTRUCTION

© THIS DETAIL MAY NOT BE APPLICABLE IN ALL CIRCUMSTANCES AND IS PROVIDED FOR INFORMATIONAL PURPOSES ONLY. SPECIFIC SITE CONDITIONS AND SCHOOL/COMMUNITY REQUIREMENTS MUST BE TAKEN INTO CONSIDERATION. COPYRIGHT RETAINED JOINTLY BY THE OAKLAND UNIFIED SCHOOL DISTRICT AND TRUST FOR PUBLIC LAND. THIS DETAIL IS NOT TO BE REPRODUCED WITHOUT PERMISSION.

 <p>OAKLAND UNIFIED SCHOOL DISTRICT Community Schools, Strong Students</p>	 <p>BAY TREE DESIGN</p>	<p>OUSD LIVING SCHOOLYARD STANDARD DETAILS</p>	DATE: OCTOBER 2022	NOT TO SCALE	DETAIL #
			<p>DECOMPOSED GRANITE (DG) WITH STABILIZING BINDER</p>		



**INTENT & BENEFIT:**

PARKTREAD IS ADA-ACCESSIBLE, HIGHLY DURABLE, INEXPENSIVE, NATURAL, SEMI-PERMEABLE, AND OFFERS A HIGH SRI VALUE.

**DESIGN NOTES:**

1. PARKTREAD CAN BE USED FOR ADA AND VEHICULAR ACCESS.
2. LOCATE LOOSE MATERIAL GROUND SURFACING AWAY FROM BUILDINGS, HIGH TRAFFIC AREAS, AND ACTIVE AREAS SUCH AS BALL PLAY.
3. PARKTREAD HAS A HIGH ALBEDO RATING, KEEPING THE SURFACE COOLER THAN ASPHALT.
4. ALL WALKING SURFACES MUST HAVE A RUNNING SLOPE < 1:20 AND A CROSS-SLOPE <1:48.

**CONSTRUCTION NOTES:**

1. CERTAIN DIMENSIONS AND SPECIFICATIONS RELIANT UPON INPUT FROM CIVIL ENGINEER AND GEOTECH REPORT ON EXISTING SOIL CONDITIONS.
2. VERIFY LOCATION OF UNDERGROUND UTILITIES, FACILITIES AND TREE ROOTS IN THE AREA.
3. VERIFY THAT SUBGRADE DRAINAGE IS INSTALLED AT PROPER ELEVATIONS AND THAT SMOOTH GRADING IS COMPLETE.
4. CORRECT SUBGRADE IRREGULARITIES TO ENSURE THAT SUBGRADE ELEVATION IS IN ACCORDANCE WITH MANUFACTURER'S REQUIREMENTS AND TO ENSURE POSITIVE DRAINAGE.
5. REMOVE ROCKS, DEBRIS, AND OTHER SIMILAR ITEMS.
6. WHERE ASPHALT IS CUT CLEANLY WITHOUT CRUMBLING OF ADJACENT CONDITION, CONCRETE CURB MAY BE FORMED DIRECTLY AGAINST ADJACENT ASPHALT. WHERE CRUMBLING OCCURS, ASPHALT IS TO BE OVERCUT TO ALLOW FOR FORMWORK AND PATCHED.
7. INSTALL TO THE SATISFACTION OF THE LANDSCAPE ARCHITECT AND/OR OUSD FACILITIES.

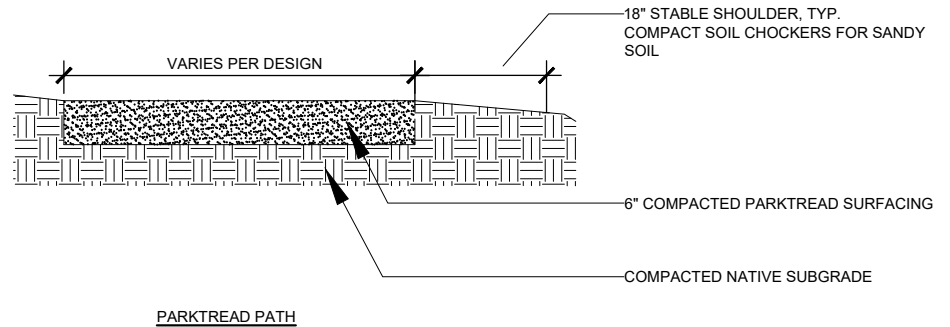

**MAINTENANCE NOTES:**

1. PARKTREAD REQUIRES LITTLE TO NO MAINTENANCE.



NOT FOR CONSTRUCTION

© THIS DETAIL MAY NOT BE APPLICABLE IN ALL CIRCUMSTANCES AND IS PROVIDED FOR INFORMATIONAL PURPOSES ONLY. SPECIFIC SITE CONDITIONS AND SCHOOL/COMMUNITY REQUIREMENTS MUST BE TAKEN INTO CONSIDERATION. COPYRIGHT RETAINED JOINTLY BY THE OAKLAND UNIFIED SCHOOL DISTRICT AND TRUST FOR PUBLIC LAND. THIS DETAIL IS NOT TO BE REPRODUCED WITHOUT PERMISSION.

 <p>OAKLAND UNIFIED SCHOOL DISTRICT Community Schools. Strong Students.</p>	 <p>BAY TREE DESIGN</p>	<p>OUSD LIVING SCHOOLYARD STANDARD DETAILS</p>	DATE: OCTOBER 2022	NOT TO SCALE	DETAIL #
			<p><b>PARKTREAD PAVING</b></p>		<p><b>2730.05</b></p>





**INTENT & BENEFIT:**

EWF AND MULCH SURFACING PROVIDES PERMEABILITY, MODERATION OF HEAT, ACCESSIBILITY (WITH EWF), WEED SUPPRESSION AND PLAY VALUE WITH A LOW-COST, SUSTAINABLE, NON-TOXIC MATERIAL.

**DESIGN NOTES:**

1. LOCATE LOOSE MATERIAL GROUND SURFACING AWAY FROM BUILDINGS, HIGH TRAFFIC AREAS, AND ACTIVE AREAS SUCH AS BALL PLAY.
2. PROVIDE DISTINCT AREAS FOR ENTRY AND EXIT TO THESE AREAS WITH A WIDE THRESHOLD MATERIAL THAT CAN BE EASILY MAINTAINED SUCH AS A CONCRETE PATH, SAND BOX EDGING WITH TRANSFER PLATFORM FOR THOSE USING A WHEELCHAIR, OR A WOODEN BRIDGE.
3. PROVIDE A DIVIDER TO KEEP PEDESTRIAN TRAFFIC FROM FLOWING OUT OF THE LOOSE MATERIAL SURFACING AREA AT SPOTS OTHER THAN THE ENTRANCE/EXIT. DIVIDERS MAY BE A FENCE, PLANTING AREA, TOPOGRAPHY CHANGE, CURB, OR EMBEDDED LOG.
4. ADA ACCESSIBILITY CAN BE ACHIEVED THROUGH A FLARED RAMP INTO EWF OR AN ALTERNATIVE SURFACE PATHWAY (I.E. PARKTREAD OR DG) THROUGH EITHER EWF OR WOOD CHIP MULCH.

**CONSTRUCTION NOTES:**

1. CERTAIN DIMENSIONS AND SPECIFICATIONS RELIANT UPON INPUT FROM CIVIL ENGINEER AND GEOTECH REPORT ON EXISTING SOIL CONDITIONS.
2. USE NATURAL COLOR EWF AND WOOD CHIPS. USING HARDWOOD WOOD CHIPS AND LARGER SIZES REDUCES RATE OF LOSS OF MATERIAL.
3. VERIFY LOCATION OF UNDERGROUND UTILITIES, FACILITIES AND TREE ROOTS IN THE AREA.
4. VERIFY THAT SUBGRADE DRAINAGE IS INSTALLED AT PROPER ELEVATIONS AND THAT SMOOTH GRADING IS COMPLETE.
5. CORRECT SUBGRADE IRREGULARITIES TO ENSURE THAT SUBGRADE ELEVATION IS IN ACCORDANCE WITH MANUFACTURER'S REQUIREMENTS AND TO ENSURE POSITIVE DRAINAGE.
6. REMOVE ROCKS, DEBRIS, AND OTHER SIMILAR ITEMS.
7. WHERE ASPHALT IS CUT CLEANLY WITHOUT CRUMBLING OF ADJACENT CONDITION, CONCRETE CURB MAY BE FORMED DIRECTLY AGAINST ADJACENT ASPHALT. WHERE CRUMBLING OCCURS, ASPHALT IS TO BE OVERCUT TO ALLOW FOR FORMWORK AND PATCHED.
8. INSTALL TO THE SATISFACTION OF THE LANDSCAPE ARCHITECT AND/OR OUSD FACILITIES.
9. PER OUSD VEGETATION POLICY (P.5), SCHOOL SITES MAY ACCEPT DONATIONS OF LOCALLY CHIPPED TREE PRUNINGS OR WOOD CHIPS FROM TREE TRIMMINGS OR OTHER APPROVED VENDORS INDICATED ON THE OUSD SCHOOL GARDEN COUNCIL'S VENDOR LIST. WOOD CHIPS MAY NOT BE ACCEPTED FROM UNAPPROVED SOURCES AS THE MATERIAL MAY CONTAIN INVASIVE PLANTS, DISEASE OR PESTS.

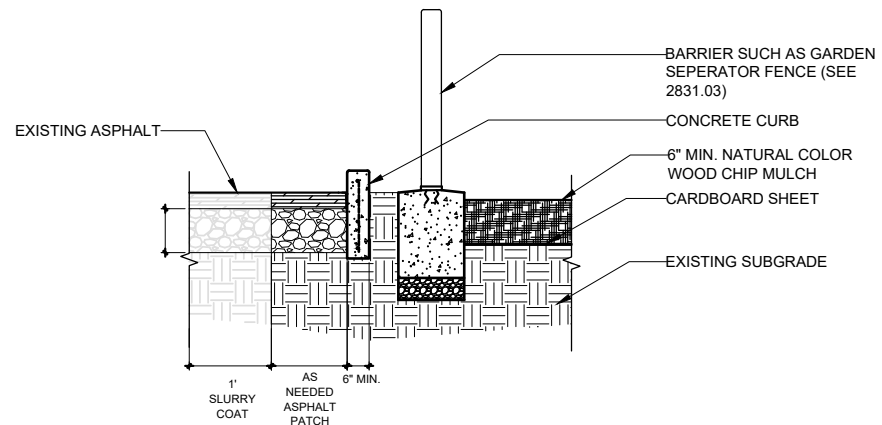
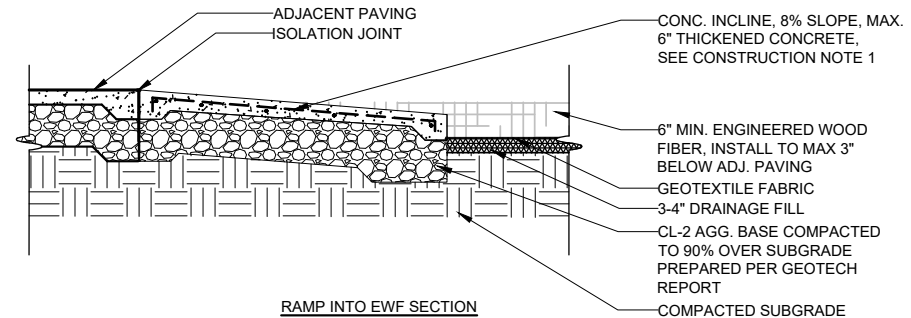

**MAINTENANCE NOTES:**

5. MATERIAL WILL NEED TO BE PERIODICALLY TOPPED OFF.



NOT FOR CONSTRUCTION

© THIS DETAIL MAY NOT BE APPLICABLE IN ALL CIRCUMSTANCES AND IS PROVIDED FOR INFORMATIONAL PURPOSES ONLY. SPECIFIC SITE CONDITIONS AND SCHOOL/COMMUNITY REQUIREMENTS MUST BE TAKEN INTO CONSIDERATION. COPYRIGHT RETAINED JOINTLY BY THE OAKLAND UNIFIED SCHOOL DISTRICT AND TRUST FOR PUBLIC LAND. THIS DETAIL IS NOT TO BE REPRODUCED WITHOUT PERMISSION.

 <p>OAKLAND UNIFIED SCHOOL DISTRICT Community Schools, Working Students</p>	 <p>BAY TREE DESIGN</p>	<p>OUSD LIVING SCHOOLYARD STANDARD DETAILS</p>	DATE: OCTOBER 2022	NOT TO SCALE	DETAIL #
			<p><b>ENGINEERED WOOD FIBER (EWF) &amp; WOOD CHIP MULCH</b></p>		

LOOSE MATERIALS SUCH AS MULCH AND ENGINEERED WOOD FIBER ARE VALUABLE ELEMENTS TO LIVING SCHOOLYARDS. MORE THAN JUST A SURFACING MATERIAL, THEY PROVIDE LOW-TECH, LOW-COST, SUSTAINABLE PLAY OPPORTUNITIES.

**BENEFITS OF LOOSE SURFACING MATERIALS:**

1. SUSTAINABILITY - PERMEABLE, MODERATE TEMPERATURES, BIODEGRADABLE, BENEFICIAL TO SOIL HEALTH
2. LOW TECH/LOW COST - TYPICALLY CAN BE INSTALLED BY NON-PROFESSIONALS AND COST LESS THAN 'PLAYGROUND ELEMENTS'
3. PLAY VALUE - PROVIDE TACTILE CREATIVE PLAY OPPORTUNITIES WHILE BEING SAFER TO FALL ONTO THAN UNITARY SURFACES SUCH AS PLAY SURFACING TILES OR POURED-IN-PLACE RUBBER.

**DRAWBACKS OF LOOSE SURFACING MATERIALS:**

1. IN UNDERSTAFFED CIRCUMSTANCES, LOOSE MATERIALS CAN POSE A PROBLEM AS SOME MAINTENANCE IS REQUIRED TO MITIGATE LOOSE MATERIAL MIGRATION TO OTHER PARTS OF THE SCHOOLYARD.

THE FOLLOWING DESIGN PRINCIPLES SHOULD BE FOLLOWED TO HELP REDUCE THE UNDESIRE EFFECTS OF USING LOOSE SURFACING MATERIALS:

1. LOCATE LOOSE MATERIAL GROUND SURFACING AWAY FROM BUILDINGS, HIGH TRAFFIC AREAS, AND ACTIVE AREAS SUCH AS BALL PLAY.
2. CONSIDER THE FUNCTION OF THE AREA YOU ARE DESIGNING AND HOW THE BENEFITS OF THE MATERIAL WILL REINFORCE THE FUNCTION WHEN SELECTING THE TYPE AND QUANTITY OF A GIVEN LOOSE SURFACING MATERIAL.
3. PROVIDE DISTINCT AREAS FOR ENTRY AND EXIT TO THESE AREAS WITH A WIDE THRESHOLD MATERIAL THAT CAN BE EASILY MAINTAINED SUCH AS A CONCRETE PATH, SAND BOX EDGING WITH TRANSFER PLATFORM FOR THOSE USING A WHEELCHAIR, OR A WOODEN BRIDGE.
4. PROVIDE A DIVIDER TO KEEP PEDESTRIAN TRAFFIC FROM FLOWING OUT OF THE LOOSE MATERIAL SURFACING AREA AT SPOTS OTHER THAN THE ENTRANCE/EXIT. DIVIDERS MAY BE A FENCE, PLANTING AREA, TOPOGRAPHY CHANGE, CURB, OR EMBEDDED LOG. IF USING A FENCE WHERE MATERIAL CAN PASS UNDERNEATH, AN ADDITIONAL BARRIER SUCH AS A CURB OR A LOG WOULD HELP LESSEN THE MIGRATION OF LOOSE MATERIALS.



A STABILIZED DECOMPOSED GRANITE THRESHOLD, FENCING AND AN EMBEDDED LOG HELP TO KEEP MULCH CONTAINED.





A BUTTERFLY GARDEN TUCKED AWAY FROM MORE ACTIVE PLAY AND SEPARATED FROM PLAY SURFACING BY DISTANCE AS WELL AS A CONCRETE SEATWALL.



SIMPLY LOCATING LOOSE MATERIALS AWAY FROM BUILDINGS AND AT A LOW POINT IN THE YARD GREATLY REDUCES THE ISSUE OF MESS AND MAINTENANCE. GRASS TRANSITIONS ACT TO WIPE OFF FEET.

NOT FOR CONSTRUCTION

© THIS DETAIL MAY NOT BE APPLICABLE IN ALL CIRCUMSTANCES AND IS PROVIDED FOR INFORMATIONAL PURPOSES ONLY. SPECIFIC SITE CONDITIONS AND SCHOOL/COMMUNITY REQUIREMENTS MUST BE TAKEN INTO CONSIDERATION. COPYRIGHT RETAINED JOINTLY BY THE OAKLAND UNIFIED SCHOOL DISTRICT AND TRUST FOR PUBLIC LAND. THIS DETAIL IS NOT TO BE REPRODUCED WITHOUT PERMISSION.

 	<b>BAY TREE DESIGN</b>	OUSD LIVING SCHOOLYARD STANDARD DETAILS	DATE: OCTOBER 2022	NOT TO SCALE	DETAIL #
			<b>LOOSE SURFACING MATERIALS</b>		

**INTENT & BENEFITS:**

ENGINEERED WOOD FIBER (EWF) IS ADA ACCESSIBLE, INEXPENSIVE, NON-TOXIC, LOWERS AMBIENT AIR TEMPERATURES, IS PERMEABLE, AND PROVIDES THE BEST ASTM-APPROVED ATTENUATED SURFACE FOR PREVENTING LONG BONE FRACTURES.

**DESIGN NOTES:**

1. ADA ACCESSIBILITY CAN BE ACHIEVED THROUGH A FLARED RAMP INTO EWF OR AN ALTERNATIVE SURFACE PATHWAY (I.E. PARKTREAD OR DG) THROUGH EWF. WHERE SPACE DOES NOT ALLOW FOR FLARED RAMP, CURBS CAN BE INSTALLED ALONG THE SIDES OF THE DIRECT ADA ROUTE.
2. LOCATE LOOSE MATERIAL GROUND SURFACING SUCH AS EWF AWAY FROM BUILDINGS, HIGH TRAFFIC AREAS, AND ACTIVE AREAS SUCH AS BALL PLAY.
3. PROVIDE DISTINCT AREAS FOR ENTRY AND EXIT TO THESE AREAS WITH A WIDE THRESHOLD MATERIAL THAT CAN BE EASILY MAINTAINED SUCH AS A CONCRETE PATH, SAND BOX EDGING WITH TRANSFER PLATFORM FOR THOSE USING A WHEELCHAIR, OR A WOODEN BRIDGE.
4. PROVIDE A DIVIDER TO KEEP PEDESTRIAN TRAFFIC FROM FLOWING OUT OF THE LOOSE MATERIAL SURFACING AREA AT SPOTS OTHER THAN THE ENTRANCE/EXIT. DIVIDERS MAY BE A FENCE, PLANTING AREA, TOPOGRAPHY CHANGE, CURB, OR EMBEDDED LOG.

**CONSTRUCTION NOTES:**

1. CERTAIN DIMENSIONS AND SPECIFICATIONS RELIANT UPON INPUT FROM CIVIL ENGINEER AND GEOTECH REPORT ON EXISTING SOIL CONDITIONS.
2. COMPLY WITH THE FOLLOWING: ACI 301, "SPECIFICATION FOR STRUCTURAL CONCRETE," SECTIONS 1 THROUGH 5; ACI 117, "SPECIFICATIONS FOR TOLERANCES FOR CONCRETE CONSTRUCTION JOINT AND MATERIALS."
3. FORM ISOLATION JOINTS OF PERFORMED JOINT-FILLER STRIPS. EXTEND JOINT FILLERS FULL WIDTH AND DEPTH OF JOINT.

**MAINTENANCE NOTES:**

1. SURFACE OF EWF TO BE KEPT ABOVE LOWEST PART OF CONCRETE RAMP TO MAINTAIN ACCESSIBILITY THROUGH RAKING AND PERIODICALLY TOPPING OFF EWF MATERIAL.

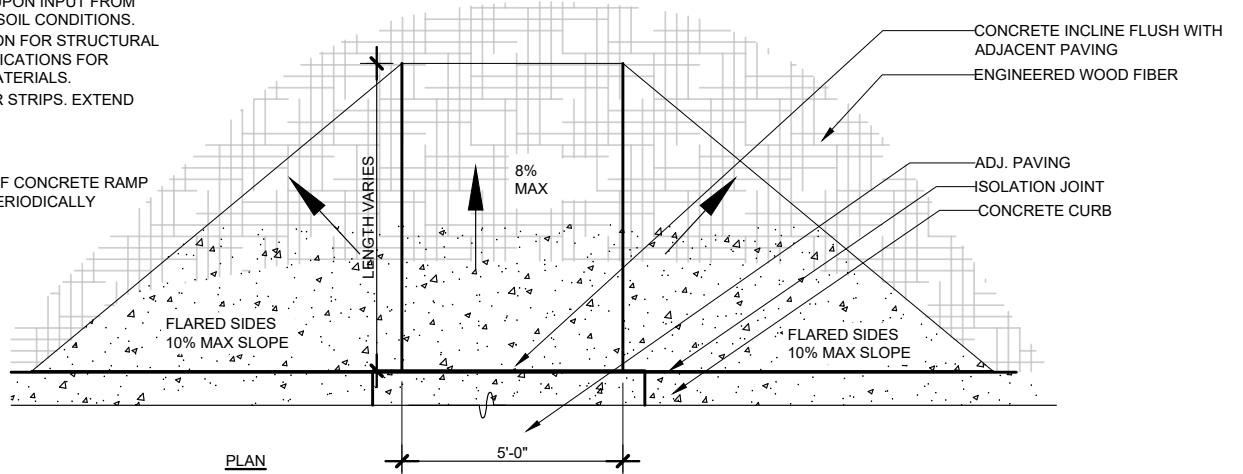
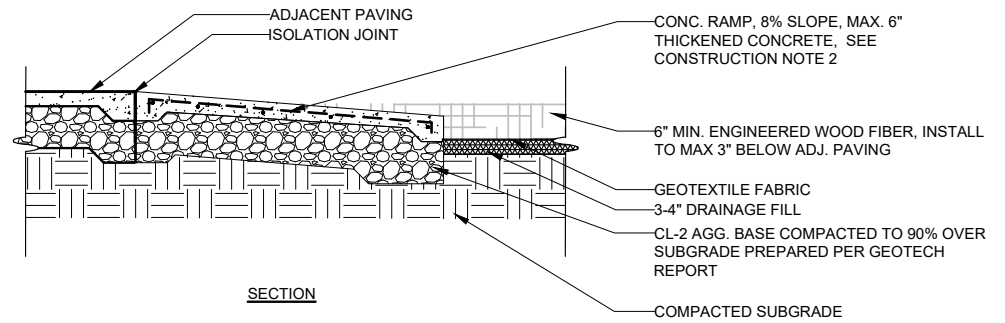

NOT FOR CONSTRUCTION

© THIS DETAIL MAY NOT BE APPLICABLE IN ALL CIRCUMSTANCES AND IS PROVIDED FOR INFORMATIONAL PURPOSES ONLY. SPECIFIC SITE CONDITIONS AND SCHOOL/COMMUNITY REQUIREMENTS MUST BE TAKEN INTO CONSIDERATION. COPYRIGHT RETAINED JOINTLY BY THE OAKLAND UNIFIED SCHOOL DISTRICT AND TRUST FOR PUBLIC LAND. THIS DETAIL IS NOT TO BE REPRODUCED WITHOUT PERMISSION.



**BAY TREE DESIGN**

OUSD LIVING SCHOOLYARD STANDARD DETAILS

DATE: OCTOBER 2022

NOT TO SCALE

DETAIL #



**ENGINEERED WOOD FIBER (EWF)**  
AS RESILIENT PAVING, WITH INCLINE DETAIL

**2740.01**

**INTENT & BENEFIT:**

ENGINEERED CORK SURFACING IS A RESILIENT SAFETY SURFACE WHICH IS RENEWABLE, NATURAL, PERMEABLE, AND DOES NOT INCREASE AMBIENT AIR TEMPERATURES.

**DESIGN NOTES:**

1. ECS CAN BE INSTALLED IN SIMILAR APPLICATIONS TO Poured-IN-PLACE RUBBER
2. ECS CAN BE INSTALLED OVER 95% CRUSHED AGGREGATE/STONE BASE OF 4-6" THICKNESS, OVER FULLY CURED ASPHALT, OR OVER CONCRETE WITH A MIN. 7 DAYS OF CURE TIME.
3. DO NOT SITUATE ECS DIRECTLY ADJACENT TO SAND.

**CONSTRUCTION NOTES:**

1. CERTAIN DIMENSIONS AND SPECIFICATIONS RELIANT UPON INPUT FROM CIVIL ENGINEER AND GEOTECH REPORT ON EXISTING SOIL CONDITIONS.
2. DO NOT PROCEED WITH PLAYGROUND SURFACING INSTALLATION UNTIL ALL APPLICABLE SITE WORK, INCLUDING SUBSTRATE PREPARATION, FENCING, PLAYGROUND EQUIPMENT INSTALLATION AND OTHER RELEVANT WORK HAS BEEN COMPLETED.
3. REMOVE ANY LOOSE MATERIAL AND FILL CRACKS IN EXISTING CONCRETE OR ASPHALT.
4. CONSIDER DUST AND TRAFFIC IN ADJACENT WORK AREAS THAT MAY IMPACT SURFACE FINISH.
5. INSTALL SURFACING ON A DRY SUB-SURFACE WITH NO PROSPECT OF RAIN WITHIN INITIAL DRYING PERIOD, AND WITHIN 40 DEGREES F AND 90 DEGREES F.
6. ALLOW TOP LAYER TO CURE FOR 2-3 DAYS (DEPENDENT ON WEATHER). AT THE END OF CURING PERIOD, VERIFY THAT THE SURFACE IS SUFFICIENTLY DRY AND FIRM TO ALLOW FOOT TRAFFIC AND USE WITHOUT DAMAGE TO THE SURFACE.
7. PRODUCT MUST CURE 28 DAYS FOR WEAR LAYER ONLY INSTALLATIONS.

**MAINTENANCE NOTES:**

1. MONTHLY REMOVAL OF LEAVES AND DEBRIS TO PREVENT ROTTING.
2. WHEN NECESSARY, CLEAN SURFACE WITH BRUSHES AND COOL WATER. A HIGH-PRESSURE WASHER MAY ALSO BE USED, BUT USING TOO HIGH A PRESSURE CAN DISSOCIATE THE GRANULES FROM EACH OTHER.

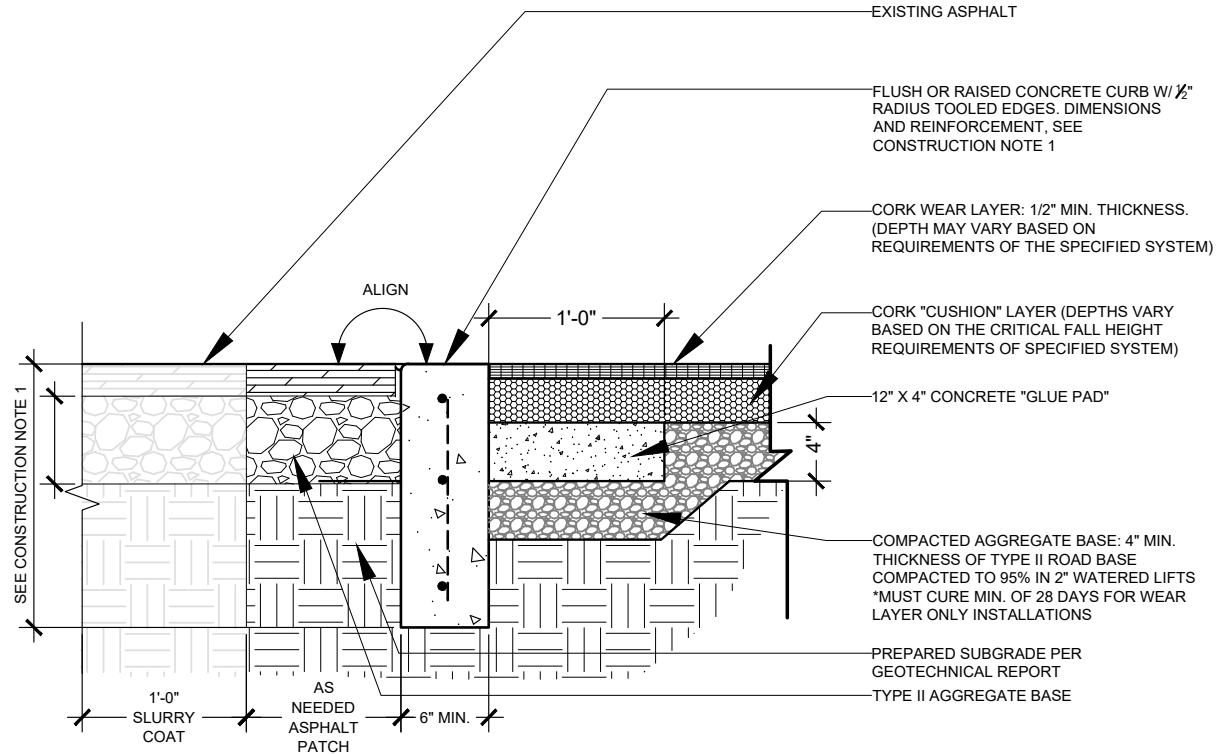

NOT FOR CONSTRUCTION

© THIS DETAIL MAY NOT BE APPLICABLE IN ALL CIRCUMSTANCES AND IS PROVIDED FOR INFORMATIONAL PURPOSES ONLY. SPECIFIC SITE CONDITIONS AND SCHOOL/COMMUNITY REQUIREMENTS MUST BE TAKEN INTO CONSIDERATION. COPYRIGHT RETAINED JOINTLY BY THE OAKLAND UNIFIED SCHOOL DISTRICT AND TRUST FOR PUBLIC LAND. THIS DETAIL IS NOT TO BE REPRODUCED WITHOUT PERMISSION.



**BAY TREE DESIGN**

OUSD LIVING SCHOOLYARD STANDARD DETAILS

DATE: OCTOBER 2022

NOT TO SCALE

DETAIL #



**ENGINEERED CORK SURFACING (CORKEEN)**

**2740.02**

**INTENT & BENEFIT:**

RAISED BEDS PROVIDE PLANTING AREAS FOR GARDENING AND PLANTS FOR PLAY AND LEARNING IN AREAS THAT DO NOT HAVE ADEQUATE IN-GROUND SOIL. THIS DETAIL IS DESIGNED TO THE SCALE OF CHILDREN, AND IS THE ONLY DSA-APPROVED ADA-ACCESSIBLE PLANTING BED. THIS DETAIL CAN BE USED IN CONJUNCTION WITH THE OUSD GARDEN TOOLKIT.

**DESIGN NOTES:**

1. DESIGNED IN COLLABORATION WITH THE SUPERVISING ARCHITECT FOR THE STATE OF CALIFORNIA EDUCATION DEPARTMENT, 'ACCESSIBLE GARDENS' OFFERS THE ONLY DSA-APPROVED ACCESSIBLE RAISED PLANTER BED. IT PROVIDES EASY ACCESSIBILITY TO THE GARDEN BED FOR ADULTS AND CHILDREN IN WHEELCHAIRS IN A COMFORTABLE, FORWARD-FACING POSITION.
2. PLANTERS MAY NOT BE PLACED WITHIN EMERGENCY ACCESS LANES. DETERMINE LOCATION OF EMERGENCY ACCESS PRIOR TO SITE SELECTION FOR PLANTERS.
3. ALL DIMENSIONS IN FEET AND INCHES. DO NOT SCALE DRAWING.
4. MANUFACTURER: ACCESSIBLE GARDENS  
 MODEL: ADA COMPLIANT 'FORWARD FACING' WHEELCHAIR GARDEN  
 MATERIAL: CEDAR OR REDWOOD  
 COLOR: NATURAL  
 SIZE: 45" WIDE X 48" LONG X 30" HIGH

**CONSTRUCTION NOTES:**

1. APPLY NON-TOXIC WOOD STAIN TO WOOD.

**MAINTENANCE NOTES:**



1. PERIODIC SANDING AND STAINING TO IMPROVE LONGEVITY
2. PERFORM ANNUAL CHECK OF JOINTS AND FASTENERS, TIGHTEN IF NECESSARY.
3. TURN OVER SOIL WITH EACH GROWING SEASON TO PROPERLY AERATE AND LOOSEN THE SOIL TO FACILITATE ROOT GROWTH.
4. REPLACE SOIL EVERY FEW YEARS FOR BEST RESULTS.



Accessible Gardens, [www.accessiblegardens.com](http://www.accessiblegardens.com)

NOT FOR CONSTRUCTION

© THIS DETAIL MAY NOT BE APPLICABLE IN ALL CIRCUMSTANCES AND IS PROVIDED FOR INFORMATIONAL PURPOSES ONLY. SPECIFIC SITE CONDITIONS AND SCHOOL/COMMUNITY REQUIREMENTS MUST BE TAKEN INTO CONSIDERATION. COPYRIGHT RETAINED JOINTLY BY THE OAKLAND UNIFIED SCHOOL DISTRICT AND TRUST FOR PUBLIC LAND. THIS DETAIL IS NOT TO BE REPRODUCED WITHOUT PERMISSION.

 <p>OAKLAND UNIFIED SCHOOL DISTRICT Community, Informed, Working Students</p>	<p><b>BAY TREE DESIGN</b></p>	<p>OUSD LIVING SCHOOLYARD STANDARD DETAILS</p>	<p>DATE: OCTOBER 2022</p>	<p>NOT TO SCALE</p>	<p>DETAIL #</p>
 <p>TRUST FOR PUBLIC LAND™</p>			<p><b>ADA RAISED PLANTER BED</b></p>	<p><b>2800.02</b></p>	

**INTENT & BENEFIT:**

RAISED BEDS PROVIDE PLANTING AREAS FOR GARDENING AND PLANTS FOR PLAY AND LEARNING IN AREAS THAT DO NOT HAVE ADEQUATE INGROUND SOIL. THIS DETAIL IS DESIGNED TO THE SCALE OF CHILDREN AND CAN BE USED IN CONJUNCTION WITH THE OUSD GARDEN TOOLKIT.

**DESIGN NOTES:**

1. PLANTERS MAY NOT BE PLACED WITHIN EMERGENCY ACCESS LANES. DETERMINE LOCATION OF EMERGENCY ACCESS PRIOR TO SITE SELECTION FOR PLANTERS.
2. ALL MATERIALS CHOSEN FOR SAFETY OF CHILDREN AND AS APPROPRIATE FOR GROWING EDIBLE PLANTS, PER OUSD GARDEN TOOLKIT.
3. PER OUSD VEGETATION POLICY (P.5), RAISED PLANTER BEDS CAN BE BUILT ON ASPHALT AS LONG AS IT IS NOT BROKEN UP AND PLANTERS ARE NOT BLOCKING DRIVEWAYS OR OTHER SAFETY ROUTES FOR STUDENTS AND/OR EMERGENCY VEHICLES. PLACE IN A SUNNY LOCATION.
4. ALL WOOD TO BE UNTREATED REDWOOD OR CEDAR. GRADE: CONSTRUCTION HEART. MOISTURE CONTENT: S-DRY. MAXIMUM MOISTURE 19% PRIOR TO INSTALLATION.
5. FASTENERS: RECYCLED CONTENT OF STEEL PRODUCTS - PROVIDE PRODUCTS WITH AN AVERAGE RECYCLED CONTENT OF STEEL PRODUCTS SO POST-CONSUMER RECYCLED CONTENT PLUS ONE-HALF OF PRE-CONSUMER RECYCLED CONTENT IS NOT LESS THAN 60 PERCENT.
6. BED LINER: MACCAFERRI MACDRAIN-C DRAINAGE COMPOSITE, OR APPROVED EQUAL.

**CONSTRUCTION NOTES:**

7. SET MEMBERS LEVEL, PLUMB, AND TRUE TO LINE. DISCARD PIECES WITH DEFECTS THAT WOULD LOWER REQUIRED STRENGTH OR RESULT IN UNACCEPTABLE APPEARANCE OF EXPOSED MEMBERS.
8. INSTALL MEMBERS FULL LENGTH WITHOUT SPLICES UNLESS OTHERWISE SPECIFICALLY DETAILED.
9. TOLERANCES: 1/4-INCH FROM TRUE POSITION, MAX. VARIATION FROM PLANE: 1/4-INCH IN 10-FEET MAX.
10. WOOD STABILIZER: TIMBER PRO INTERNAL WOOD STABILIZER BY TIMBER PRO UV USA, OR APPROVED EQUAL. TREAT ALL EXPOSED WOOD SURFACES WITH WOOD STABILIZER PROVIDING AN EVEN COATING ON ALL SURFACES PER MANUFACTURER'S INSTRUCTIONS.
11. INSTALL TO THE SATISFACTION OF THE LANDSCAPE ARCHITECT AND/OR OUSD FACILITIES.

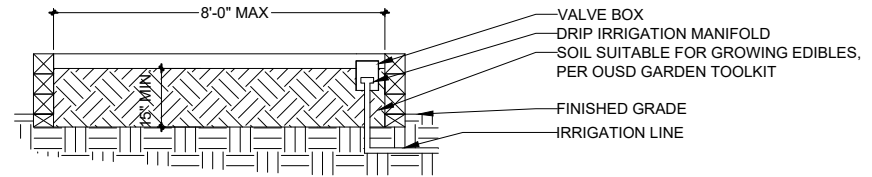

**SECTION ELEVATION**

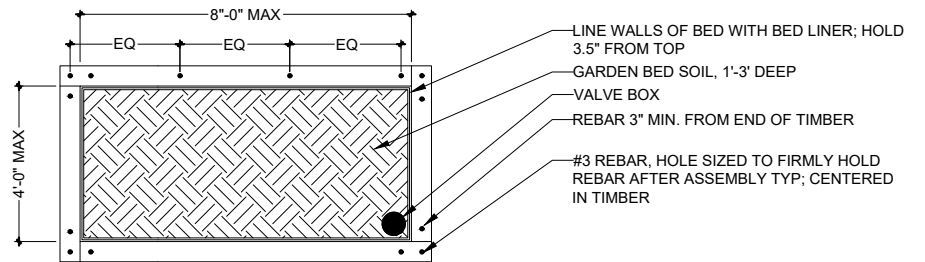

**PLAN**

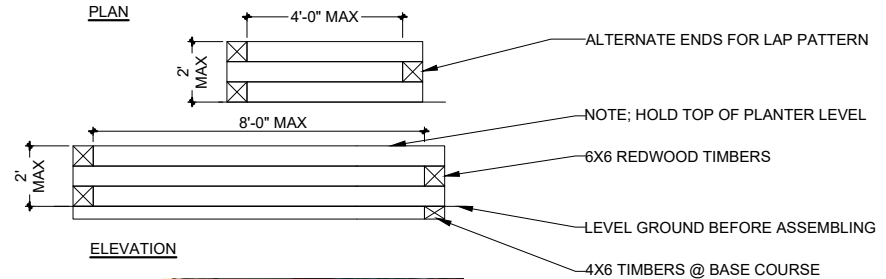

**ELEVATION**



NOT FOR CONSTRUCTION

© THIS DETAIL MAY NOT BE APPLICABLE IN ALL CIRCUMSTANCES AND IS PROVIDED FOR INFORMATIONAL PURPOSES ONLY. SPECIFIC SITE CONDITIONS AND SCHOOL/COMMUNITY REQUIREMENTS MUST BE TAKEN INTO CONSIDERATION. COPYRIGHT RETAINED JOINTLY BY THE OAKLAND UNIFIED SCHOOL DISTRICT AND TRUST FOR PUBLIC LAND. THIS DETAIL IS NOT TO BE REPRODUCED WITHOUT PERMISSION.



**BAY TREE DESIGN**

OUSD LIVING  
SCHOOLYARD  
STANDARD  
DETAILS

DATE: OCTOBER 2022

NOT TO SCALE

DETAIL #



**RAISED PLANTER BED**

**2800.03**

**INTENT & BENEFIT:**  
 STOCK TANKS AFFORD AN EASY AND LOW-COST WAY TO ADD PLANTER BEDS TO A SCHOOLYARD. BECAUSE THEY DO NOT REQUIRE POWER TOOLS TO INSTALL, THEY CAN BE INSTALLED BY VOLUNTEERS ON A COMMUNITY WORKDAY.

**DESIGN NOTES:**

1. STOCK TANKS MAY NOT BE PLACED WITHIN EMERGENCY ACCESS LANES. DETERMINE LOCATION OF EMERGENCY ACCESS PRIOR TO SITE SELECTION FOR PLANTERS.
2. CAN BE PAINTED
3. SOURCE LOCALLY AT HARDWARE STORES AND GARDEN CENTERS.
4. COMMONLY AVAILABLE IN 2' WIDE BY 4', 6', AND 8' LONG, AS WELL AS CURCULAR SHAPES.
5. 24" HEIGHT MINIMUM

**CONSTRUCTION NOTES:**

1. PRE-DRILL 1/2" HOLES EVERY 12 TO 16" PRIOR TO INSTALLATION AND FILLING - SOME STOCK TANKS COME WITH EXISTING HOLES.
2. INSTALL DRAIN CLOTH TO AVOID SOIL LOSS THROUGH HOLES.
3. SET ON A FLAT, SOLID SURFACE.



NOT FOR CONSTRUCTION

© THIS DETAIL MAY NOT BE APPLICABLE IN ALL CIRCUMSTANCES AND IS PROVIDED FOR INFORMATIONAL PURPOSES ONLY. SPECIFIC SITE CONDITIONS AND SCHOOL/COMMUNITY REQUIREMENTS MUST BE TAKEN INTO CONSIDERATION. COPYRIGHT RETAINED JOINTLY BY THE OAKLAND UNIFIED SCHOOL DISTRICT AND TRUST FOR PUBLIC LAND. THIS DETAIL IS NOT TO BE REPRODUCED WITHOUT PERMISSION.

	<b>BAY TREE DESIGN</b>	OUSD LIVING SCHOOLYARD STANDARD DETAILS	DATE: OCTOBER 2022	NOT TO SCALE	DETAIL #
			<b>STOCK TANK PLANTERS</b>	<b>2800.04</b>	

**INTENT & BENEFIT:**

BOULDERS PROVIDE SEATING, GREAT NATURE EXPLORATION ELEMENTS, SLOPE STABILIZATION AND CURRICULUM OPPORTUNITIES. BOULDERS ARE INEXPENSIVE AND EASY TO INSTALL.

**DESIGN NOTES:**

1. BOULDERS IN A CLUSTER TO BE A MAXIMUM OF 2' DISTANCE APART.
2. ENSURE MINIMUM 6' DISTANCE BETWEEN ALL OTHER FIXED OBJECTS.
3. LOCATE AWAY FROM PATHS TO AVOID TRIPPING. BOULDERS TO BE LOCATED IN LESS ACTIVE PLAY AREAS SUCH AS NATURE PLAY AND GARDEN AREAS.
4. SPECIFY AND SELECT BOULDERS THAT OFFER CURRICULUM OPPORTUNITIES RELATED TO GEOLOGY AND/OR HISTORY.
5. INTEGRATE ACCESSIBILITY IN THESE ELEMENTS TO ALL STUDENTS, LEAVING A SPOT WITH 30"x48" CLEARANCE NEXT TO THESE ELEMENTS (OR SIMILAR SEATING NEARBY).

**CONSTRUCTION NOTES:**

1. SPECIFIED DEPTHS OF MULCH AND TOPSOIL ARE DEPTHS AFTER SETTLEMENT, SPECIFIED DEPTH OF GRANULAR BASE IS COMPACTED DEPTH. 95% COMPACTION IS RECOMMENDED.
2. ALL BOULDERS TO BE SIZED AS INDICATED IN THE FIELD OR ON DRAWINGS.
3. LANDSCAPE ARCHITECT TO LOCATE BOULDERS IN FIELD.
4. ENSURE THAT ALL BOULDERS ARE STABLE AND FREE FROM ALL MOVEMENT AFTER INSTALLATION IS COMPLETE.
5. PRIOR TO PROJECT COMPLETION ENSURE THAT ALL SHARP CORNERS AND EDGES ON EXPOSED SIDES OF STONES ARE ELIMINATED (ROUNDED) BY GRINDING OR OTHER SIMILAR MEANS TO SATISFACTION OF THE LANDSCAPE ARCHITECT AND/OR OUSD PROJECT MANAGER.
6. ENSURE THAT ALL STONE BOULDERS ARE INSTALLED WITH SEATING SURFACE LEVEL.
7. INSTALLATION OF BOULDERS TO BE TO THE SATISFACTION OR THE LANDSCAPE ARCHITECT AND/OR OUSD PROJECT MANAGER.

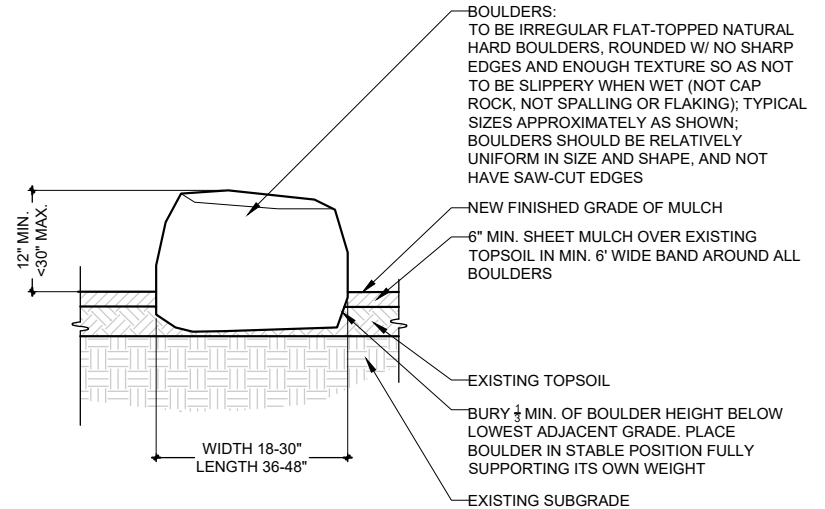

**SECTION**

NOT FOR CONSTRUCTION

© THIS DETAIL MAY NOT BE APPLICABLE IN ALL CIRCUMSTANCES AND IS PROVIDED FOR INFORMATIONAL PURPOSES ONLY. SPECIFIC SITE CONDITIONS AND SCHOOL/COMMUNITY REQUIREMENTS MUST BE TAKEN INTO CONSIDERATION. COPYRIGHT RETAINED JOINTLY BY THE OAKLAND UNIFIED SCHOOL DISTRICT AND TRUST FOR PUBLIC LAND. THIS DETAIL IS NOT TO BE REPRODUCED WITHOUT PERMISSION.

 <b>OAKLAND UNIFIED SCHOOL DISTRICT</b> <small>Community Schools. Strong Students.</small>	<b>BAY TREE DESIGN</b>	OUSD LIVING SCHOOLYARD STANDARD DETAILS	DATE: OCTOBER 2022	NOT TO SCALE	DETAIL #
			<b>SINGLE BOULDER SEATING</b>		<b>2800.05</b>





**INTENT & BENEFIT:**

STONE CIRCLES PROVIDE SOCIAL SEATING, GREAT NATURE PLAY ELEMENTS, EDUCATIONAL OPPORTUNITIES, ARE DURABLE AND EASY TO CONSTRUCT.

**DESIGN NOTES:**

1. GAPS BETWEEN STONES IN CLUSTER ARE TO RANGE FROM 10" TO 24" TO REDUCE DANGER OF ENTANGLEMENT AND ENTRAPMENT. CLUSTERS OF STONES TO BE A MINIMUM OF 6' DISTANCE APART.
2. ENSURE MINIMUM 6' DISTANCE BETWEEN ALL BOULDERS NOT IN CLUSTER, TREE TRUNKS AND/OR TREE CAGES, OR OTHER FIXED OBJECTS.
3. SELECT BOULDERS THAT DO NOT HAVE SHARP EDGES AND HAVE ENOUGH TEXTURE THAT THEY ARE NOT SLIPPERY WHEN WET.
4. SELECT BOULDERS THAT OFFER CURRICULUM OPPORTUNITIES RELATED TO GEOLOGY AND/OR HISTORY.

**CONSTRUCTION NOTES:**

1. SPECIFIED DEPTHS OF MULCH AND TOPSOIL ARE DEPTHS AFTER SETTLEMENT, SPECIFIED DEPTH OF GRANULAR BASE IS COMPACTED DEPTH. 95% COMPACTION IS RECOMMENDED.
2. INSTALL ALL BOULDERS WITH MINIMUM ONE-THIRD BELOW FINISHED GRADE OF SURROUNDING MULCH AS SHOWN IN SINGLE BOULDER DETAIL.
3. ENSURE THAT ALL BOULDERS ARE STABLE AND FREE FROM ALL MOVEMENT AFTER INSTALLATION IS COMPLETE.
4. ENSURE THAT ALL STONE BOULDERS ARE INSTALLED WITH SEATING SURFACE LEVEL.
5. PRIOR TO PROJECT COMPLETION ENSURE THAT ALL SHARP CORNERS AND EDGES ON EXPOSED SIDES OF STONES ARE ELIMINATED (ROUNDED) BY GRINDING OR OTHER SIMILAR MEANS TO SATISFACTION OF THE LANDSCAPE ARCHITECT AND/OR OUSD PROJECT MANAGER.
6. INSTALLATION OF BOULDERS TO BE TO THE SATISFACTION OR THE LANDSCAPE ARCHITECT AND/OR OUSD PROJECT MANAGER.

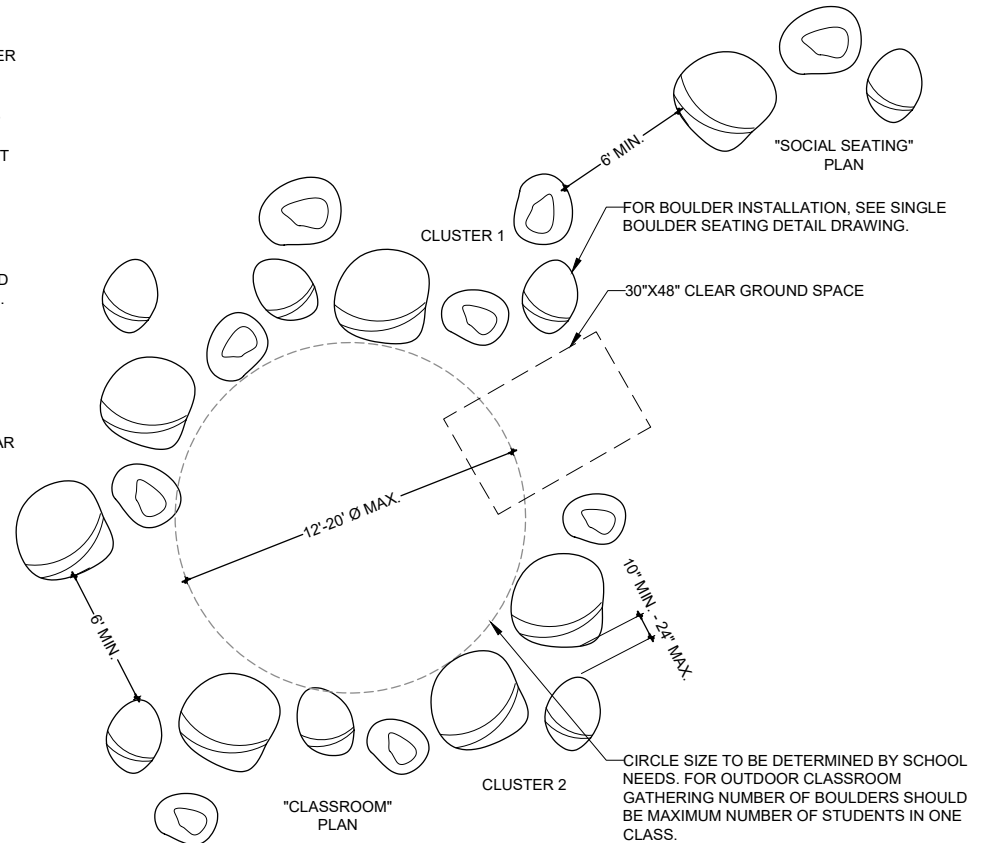

NOT FOR CONSTRUCTION

© THIS DETAIL MAY NOT BE APPLICABLE IN ALL CIRCUMSTANCES AND IS PROVIDED FOR INFORMATIONAL PURPOSES ONLY. SPECIFIC SITE CONDITIONS AND SCHOOL/COMMUNITY REQUIREMENTS MUST BE TAKEN INTO CONSIDERATION. COPYRIGHT RETAINED JOINTLY BY THE OAKLAND UNIFIED SCHOOL DISTRICT AND TRUST FOR PUBLIC LAND. THIS DETAIL IS NOT TO BE REPRODUCED WITHOUT PERMISSION.

 		OUSD LIVING SCHOOLYARD STANDARD DETAILS	DATE: OCTOBER 2022	NOT TO SCALE	DETAIL #
			<h1>MULTIPLE BOULDER SEATING</h1>		

**INTENT & BENEFIT:**

LOG SEATING CONTRIBUTES TO THE NATURAL FEEL OF A LIVING SCHOOLYARD WHILE PROVIDING SEATING AS WELL AS BOUNDARIES BETWEEN PLAY ELEMENTS AND SURFACING.

**DESIGN NOTES:**

- MULTIPLE SEATING LOGS MAY BE INSTALLED END-TO-END IN A ZIG-ZAG PATTERN, ANGLE CUT ENDS TO CREATE MITER JOINT. ENSURE MAXIMUM  $\frac{1}{4}$ " GAP AT JOINT.

**CONSTRUCTION NOTES:**

- SPECIFIED DEPTH OF TOPSOIL IS DEPTH AFTER SETTLEMENT. SPECIFIED DEPTH OF DECOMPOSED GRANITE IS COMPACTED DEPTH. 95% COMPACTION IS RECOMMENDED.
- ALL SEATING LOGS TO BE SOLID CEDAR OR REDWOOD WITH BARK REMOVED AND SKINNED/TURNED TO REMOVE IRREGULARITIES SUCH AS BRANCH STUBS.
- ALL LOGS TO BE INSTALLED WITH SEATING SURFACE LEVEL END-TO-END.
- TOP AND SIDES TO BE SANDED SMOOTH TO LIMIT SPLINTERS. CORNERS ROUTED  $\frac{1}{4}$ " RADIUS OR SANDED TO AVOID SHARP EDGES.
- ALL TIMBER, LUMBER, AND LOGS TO BE FREE FROM WARPS, CHECKS AND CRACKS.
- LOG BENCH INSTALLATION TO BE TO THE SATISFACTION OF THE LANDSCAPE ARCHITECT AND/OR OUSD PROJECT MANAGER.
- GREEN WASTE RECYCLE CAN HEWN THE LOGS FLAT ON TOP AND BOTTOM.

**MAINTENANCE NOTES:**

- LOGS MAY BE SANDED TO REDUCE THE RISK OF SPLINTERS EVERY 5-7 YEARS.

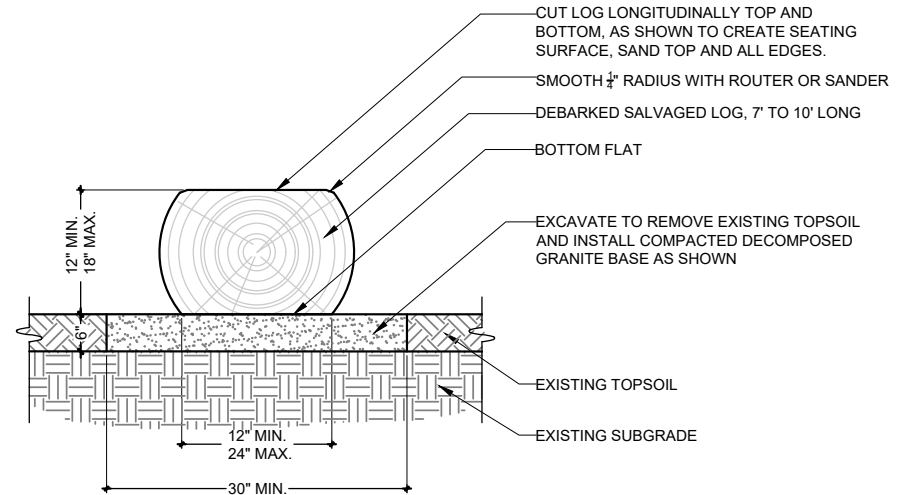

SECTION

NOT FOR CONSTRUCTION



THIS DETAIL MAY NOT BE APPLICABLE IN ALL CIRCUMSTANCES AND IS PROVIDED FOR INFORMATIONAL PURPOSES ONLY. SPECIFIC SITE CONDITIONS AND SCHOOL/COMMUNITY REQUIREMENTS MUST BE TAKEN INTO CONSIDERATION. COPYRIGHT RETAINED JOINTLY BY THE OAKLAND UNIFIED SCHOOL DISTRICT AND TRUST FOR PUBLIC LAND. THIS DETAIL IS NOT TO BE REPRODUCED WITHOUT PERMISSION.

		OUSD LIVING SCHOOLYARD STANDARD DETAILS	DATE: OCTOBER 2022	NOT TO SCALE	DETAIL #
			<h2>FIXED LOG SEATING</h2>		<h1>2800.07</h1>

**INTENT & BENEFITS:**

TREE ROUND SEATING ADDS TOPOGRAPHICAL INTEREST TO NATURE PLAY AREAS AS WELL AS SEATING OPTIONS USING A NATURAL MATERIAL

**DESIGN NOTES:**

1. ALL SEATING STUMPS TO BE INSTALLED VERTICAL AND WITH TOPS CUT HORIZONTAL VARY HEIGHTS AS INDICATED ON SECTION.
2. GAPS BETWEEN STUMP TO RANGE BETWEEN 10" AND 24" TO REDUCE DANGER OF ENTANGLEMENT AND ENTRAPMENT.
3. ENSURE 6' MINIMUM DISTANCE BETWEEN ALL OTHER FIXED OBJECTS.

**CONSTRUCTION NOTES:**

1. SPECIFIED DEPTH OF TOPSOIL IS DEPTH AFTER SETTLEMENT. SPECIFIED DEPTH OF DRAINAGE ROCK IS COMPACTED DEPTH. 95% COMPACTION IS RECOMMENDED.
2. ALL WOOD TO BE SOLID CEDAR OR REDWOOD WITH BARK REMOVED AND SKINNED/TURNED TO REMOVE IRREGULARITIES SUCH AS BRANCH STUBS. ALL WOOD TO BE SANDED AND FREE OF SPLINTERS.
3. ALL TIMBER, LUMBER AND LOGS TO BE FREE FROM WARPS, CHECKS, AND CRACKS.
4. STUMP SEATING INSTALLATION TO BE TO THE SATISFACTION OF THE LANDSCAPE ARCHITECT AND/OR OUSD PROJECT MANAGER.
5. TREE ROUNDS CAN BE SOURCED THROUGH OUSD GARDEN REQUEST FORM.

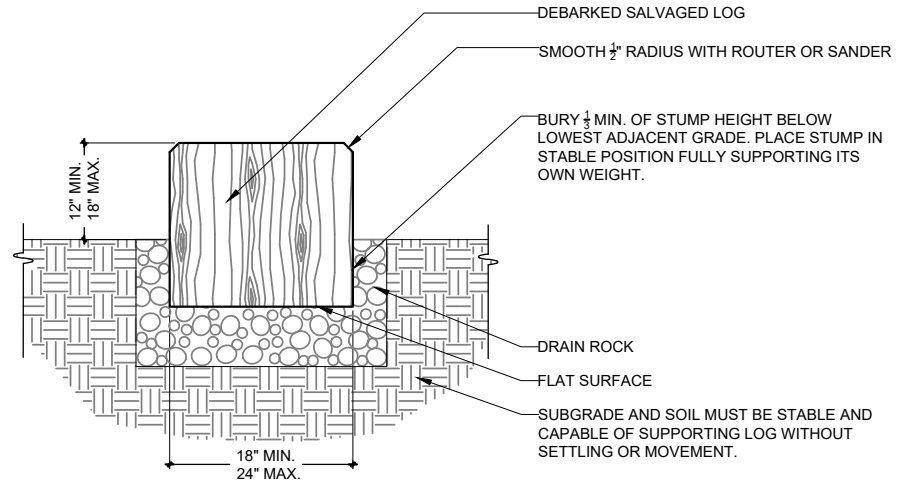

**SECTION**

NOT FOR CONSTRUCTION

© THIS DETAIL MAY NOT BE APPLICABLE IN ALL CIRCUMSTANCES AND IS PROVIDED FOR INFORMATIONAL PURPOSES ONLY. SPECIFIC SITE CONDITIONS AND SCHOOL/COMMUNITY REQUIREMENTS MUST BE TAKEN INTO CONSIDERATION. COPYRIGHT RETAINED JOINTLY BY THE OAKLAND UNIFIED SCHOOL DISTRICT AND TRUST FOR PUBLIC LAND. THIS DETAIL IS NOT TO BE REPRODUCED WITHOUT PERMISSION.

 <p>OAKLAND UNIFIED SCHOOL DISTRICT Community Schools. Strong Students.</p>	 <p>BAY TREE DESIGN</p>	<p>OUSD LIVING SCHOOLYARD STANDARD DETAILS</p>	DATE: OCTOBER 2022	NOT TO SCALE	DETAIL #
			<p><b>FIXED TREE ROUND SEATING</b></p>		



**INTENT & BENEFIT:**

TREE ROUND SEATING ADDS TOPOGRAPHICAL INTEREST TO NATURE PLAY AREAS AS WELL AS SEATING OPTIONS USING A NATURAL MATERIAL.

**DESIGN NOTES:**

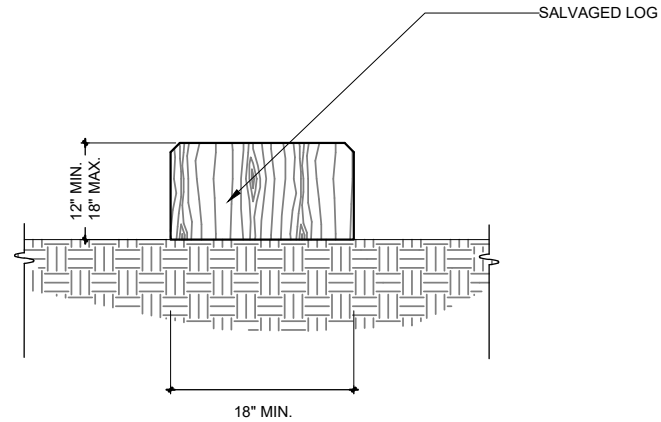

1. STUMPS SHOULD BE SMALL ENOUGH TO MOVE, BUT NOT LIGHT ENOUGH FOR CHILDREN TO PICK UP EASILY.
2. GAPS BETWEEN STUMP TO RANGE BETWEEN 10" AND 24" TO REDUCE DANGER OF ENTANGLEMENT AND ENTRAPMENT.
3. ENSURE 6" MINIMUM DISTANCE BETWEEN ALL OTHER FIXED OBJECTS.
4. TREE ROUNDS CAN BE OBTAINED THROUGH OUSD



SECTION

NOT FOR CONSTRUCTION

© THIS DETAIL MAY NOT BE APPLICABLE IN ALL CIRCUMSTANCES AND IS PROVIDED FOR INFORMATIONAL PURPOSES ONLY. SPECIFIC SITE CONDITIONS AND SCHOOL/COMMUNITY REQUIREMENTS MUST BE TAKEN INTO CONSIDERATION. COPYRIGHT RETAINED JOINTLY BY THE OAKLAND UNIFIED SCHOOL DISTRICT AND TRUST FOR PUBLIC LAND. THIS DETAIL IS NOT TO BE REPRODUCED WITHOUT PERMISSION.

 <p>OAKLAND UNIFIED SCHOOL DISTRICT Community Schools. Strong Students.</p>	 <p>BAY TREE DESIGN</p>	<p>OUSD LIVING SCHOOLYARD STANDARD DETAILS</p>	DATE: OCTOBER 2022	NOT TO SCALE	DETAIL #
			<p><b>MOVEABLE TREE ROUND SEATING</b></p>		



**INTENT & BENEFIT:**

THIS FENCE IS INEXPENSIVE, LIGHT-WEIGHT, AND OFFERS A FLEXIBLE SOLUTION TO KEEP BALLS IN ACTIVE BALL PLAY AREAS WHEN NEEDED.

**DESIGN NOTES:**

1. COMMERCIAL GRADE FULLY EDGED SPORT NETTING WITH UV STABILIZING MATERIAL.
2. ALL METAL PARTS TO BE GALVANIZED STEEL; ALL HARDWARE TO BE STAINLESS STEEL.
3. WHEN LOCATING FENCING, CONSIDER CIRCULATION AND NECESSARY OPENINGS AND/OR GATES.

**CONSTRUCTION NOTES:**

1. STAKE CENTER OF EACH POST AND RECEIVE WRITTEN APPROVAL FROM OWNER REPRESENTATIVE PRIOR TO INSTALLATION. SPACING SHALL BE ADJUSTED TO AVOID DAMAGE TO EXISTING TREE ROOTS GREATER THAN 2 INCHES.
2. STRUCTURAL ENGINEER TO PROVIDE FOOTING DIMENSIONS AND REINFORCEMENT ELEMENTS PER GEOTECH REPORT.
3. CONTRACTOR TO PROVIDE WARRANTY STATING THAT THE FENCING IS SECURE AND STABLE, TIGHT, CORROSION-FREE, IN PROPER ALIGNMENT, COMPLETE IN DETAIL AND FINISH AND FREE OF HAZARDOUS CONDITIONS AT FINAL ACCEPTANCE AND FOR A PERIOD OF ONE YEAR FOLLOWING FINAL CLOSE OUT.

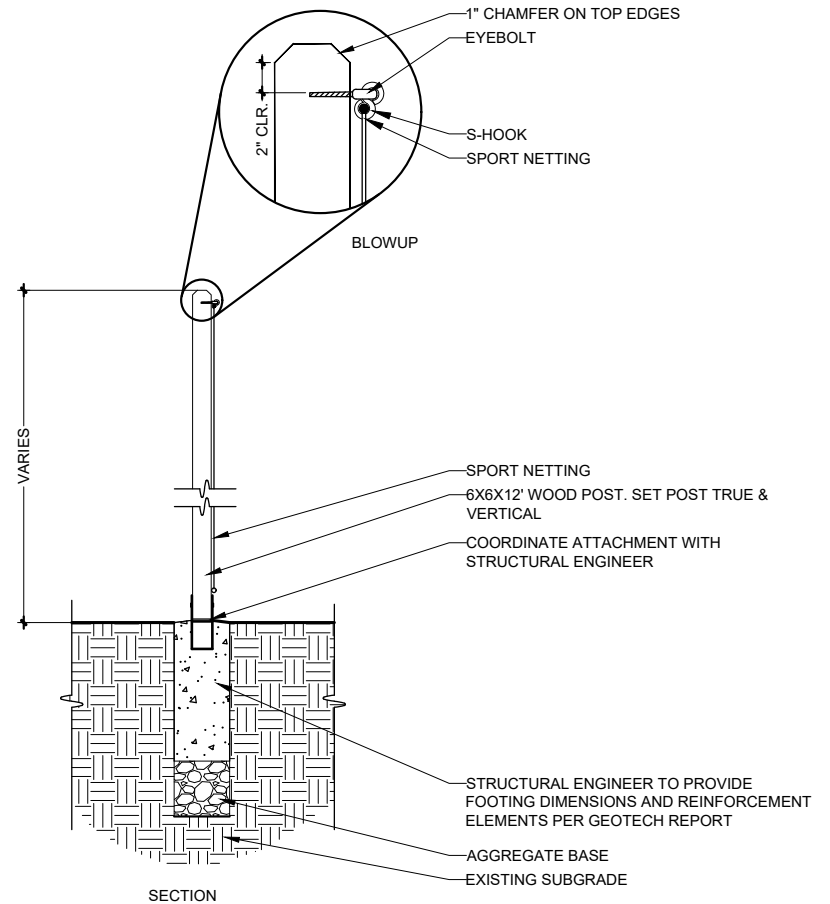

NOT FOR CONSTRUCTION

© THIS DETAIL MAY NOT BE APPLICABLE IN ALL CIRCUMSTANCES AND IS PROVIDED FOR INFORMATIONAL PURPOSES ONLY. SPECIFIC SITE CONDITIONS AND SCHOOL/COMMUNITY REQUIREMENTS MUST BE TAKEN INTO CONSIDERATION. COPYRIGHT RETAINED JOINTLY BY THE OAKLAND UNIFIED SCHOOL DISTRICT AND TRUST FOR PUBLIC LAND. THIS DETAIL IS NOT TO BE REPRODUCED WITHOUT PERMISSION.

<p>OAKLAND UNIFIED SCHOOL DISTRICT Community Schools, Strong Students</p>	<p>BAY TREE DESIGN</p>	<p>OUSD LIVING SCHOOLYARD STANDARD DETAILS</p>	DATE: OCTOBER 2022	NOT TO SCALE	DETAIL #
			<p><b>BALL COURT FENCING</b></p>		<p><b>2831.01</b></p>



**INTENT & BENEFIT:**

NATURAL MATERIAL, APPROPRIATELY PROPORTIONED FENCING ACTS AS A SEPERATOR BETWEEN GARDEN AREAS, PROTECTING THEM FROM MORE ACTIVE PLAY, WHILE MAINTAINING VISIBILITY WITHIN THE SITE.

**DESIGN NOTES:**

1. WHEN LOCATING FENCING, CONSIDER CIRCULATION AND NECESSARY OPENINGS AND/OR GATES.
2. AS FENCING IS USED TO CONTAIN LOOSE SURFACING MATERIAL, INSTALL A RAISED CURB OR LOGS TO MORE FULLY CONTAIN MATERIAL.

**CONSTRUCTION NOTES:**

1. MATERIALS: NATIONAL LUMBER GRADES AUTHORITY (NLGA), OR WWPA (WESTERN WOOD PRODUCTS ASSOC.). NEW CEDAR OR REDWOOD, UNTREATED. GRADE: CONSTRUCTION HEART. FSC CERTIFIED.
2. WOOD MOISTURE CONTENT: MILL STAMPED S-DRY. MAX MOISTURE 19% PRIOR TO INSTALLATION. LUMBER SHALL EXHIBIT NO GROWTH OF FUNGUS WHEN INSTALLED.
3. ALL METAL PARTS TO BE GALVANIZED STEEL; ALL HARDWARE TO BE STAINLESS STEEL.
4. ALL EXPOSED EDGES TO BE FILLETED TO  $\frac{3}{4}$ " RADIUS.
5. STAKE CENTER OF EACH POST AND RECEIVE WRITTEN APPROVAL FROM OWNER REPRESENTATIVE PRIOR TO INSTALLATION. SPACING SHALL BE ADJUSTED TO AVOID DAMAGE TO EXISTING TREE ROOTS GREATER THAN 2 INCHES.
6. STRUCTURAL ENGINEER TO PROVIDE FOOTING DIMENSIONS AND REINFORCEMENT ELEMENTS PER GEOTECH REPORT.
7. CONTRACTOR TO PROVIDE WARRANTY STATING THAT THE FENCING IS SECURE AND STABLE, TIGHT, CORROSION-FREE, SANDED/FINISHED TO BE SPLINTER RESISTANT, IN PROPER ALIGNMENT, COMPLETE IN DETAIL AND FINISH AND FREE OF HAZARDOUS CONDITIONS AT FINAL ACCEPTANCE AND FOR A PERIOD OF ONE YEAR FOLLOWING FINAL CLOSE OUT.

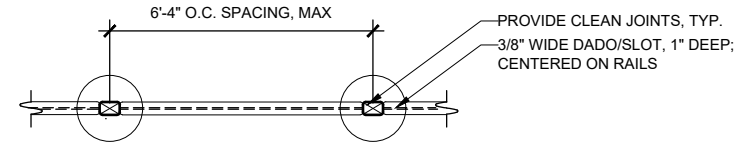

PLAN

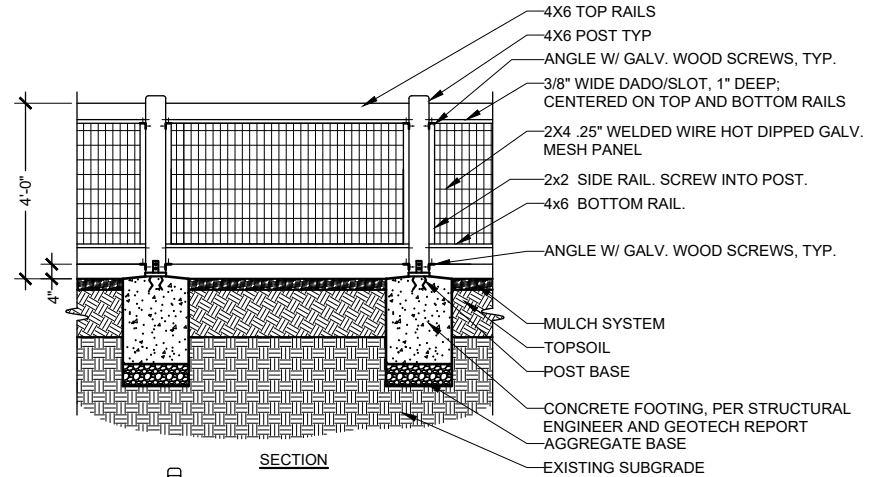

SECTION

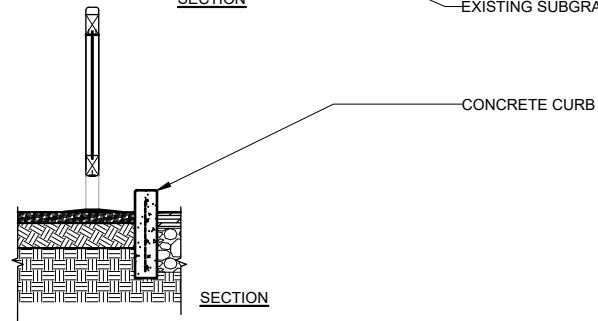

SECTION

NOT FOR CONSTRUCTION

© THIS DETAIL MAY NOT BE APPLICABLE IN ALL CIRCUMSTANCES AND IS PROVIDED FOR INFORMATIONAL PURPOSES ONLY. SPECIFIC SITE CONDITIONS AND SCHOOL/COMMUNITY REQUIREMENTS MUST BE TAKEN INTO CONSIDERATION. COPYRIGHT RETAINED JOINTLY BY THE OAKLAND UNIFIED SCHOOL DISTRICT AND TRUST FOR PUBLIC LAND. THIS DETAIL IS NOT TO BE REPRODUCED WITHOUT PERMISSION.



**BAY TREE DESIGN**

OUSD LIVING SCHOOLYARD STANDARD DETAILS

DATE: OCTOBER 2022

NOT TO SCALE

DETAIL #

**GARDEN SEPARATOR FENCE**

**2831.02**



**INTENT & BENEFIT:**

STORMWATER FENCING PROTECTS THE SOIL AND PLANTS WITHIN STORMWATER AREAS, WHILE OFFERING A VISUAL DEMARCATION OF AN OFF-LIMITS AREA TO KEEP SOIL FROM BEING COMPACTED.

**DESIGN NOTES:**

1. INCORPORATE SIGNAGE FOR EDUCATIONAL PURPOSES.
2. MAKE PART OF THE STORMWATER COLLECTION SYSTEM ACCESSIBLE TO CHILDREN WHERE STORMWATER IS CONSIDERED CLEAN SO THAT THEY MAY INTERACT WITH IT FOR LEARNING AND PLAY PURPOSES.

**CONSTRUCTION NOTES:**

1. MATERIALS: NATIONAL LUMBER GRADES AUTHORITY (NLGA), OR WWPA (WESTERN WOOD PRODUCTS ASSOC.), NEW CEDAR OR REDWOOD, UNTREATED. GRADE: CONSTRUCTION HEART, FSC CERTIFIED.
2. WOOD MOISTURE CONTENT: MILL STAMPED S-DRY. MAX MOISTURE 19% PRIOR TO INSTALLATION. LUMBER SHALL EXHIBIT NO GROWHT OF FUNGUS WHEN INSTALLED.
3. ALL METAL PARTS TO BE GALVANIZED STEEL; ALL HARDWARE TO BE STAINLESS STEEL.
4. ALL EXPOSED EDGES TO BE FILLETED TO  $\frac{3}{8}$ " RADIUS.
5. STAKE CENTER OF EACH POST AND RECEIVE WRITTEN APPROVAL FROM OWNER REPRESENTATIVE PRIOR TO INSTALLATION. SPACING SHALL BE ADJUSTED TO AVOID DAMAGE TO EXISTING TREE ROOTS GREATER THAN 2 INCHES.
6. STRUCTURAL ENGINEER TO PROVIDE FOOTING DIMENSIONS AND REINFORCEMENT ELEMENTS PER GEOTECH REPORT.
7. CONTRACTOR TO PROVIDE WARRANTY STATING THAT THE FENCING IS SECURE AND STBLE, TIGHT, CORROSION-FREE, IN PROPER ALIGNMENT, COMPLETE IN DETAIL AND FINISH AND FREE OF HAZARDOUS CONDITIONS AT FINAL ACCEPTANCE AND FOR A PERIOD OF ONE YEAR FOLLOWING FINAL CLOSE-OUT.

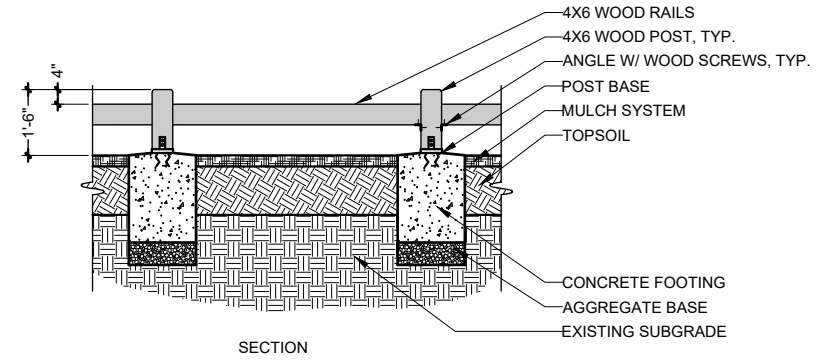
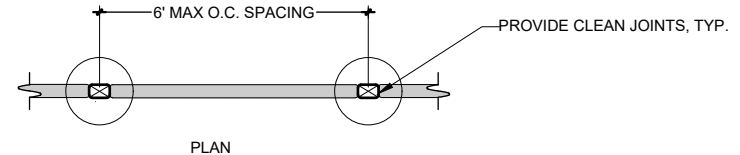

© THIS DETAIL MAY NOT BE APPLICABLE IN ALL CIRCUMSTANCES AND IS PROVIDED FOR INFORMATIONAL PURPOSES ONLY. SPECIFIC SITE CONDITIONS AND SCHOOL/COMMUNITY REQUIREMENTS MUST BE TAKEN INTO CONSIDERATION. COPYRIGHT RETAINED JOINTLY BY THE OAKLAND UNIFIED SCHOOL DISTRICT AND TRUST FOR PUBLIC LAND. THIS DETAIL IS NOT TO BE REPRODUCED WITHOUT PERMISSION.

		OUSD LIVING SCHOOLYARD STANDARD DETAILS	DATE: OCTOBER 2022	NOT TO SCALE	DETAIL #
			<h1>STORMWATER FENCE</h1>		<h1>2831.03</h1>

**INTENT & BENEFITS:**

ESTABLISHMENT FENCES PROVIDE A VISUAL DEMARICATION OF TEMPORARY OFF-LIMITS AREAS WHILE NEW PLANTINGS ARE ESTABLISHED.

**NOTES:**

1. POWERSAND TOP OF POST TO CREATE SMOOTH, FLAT TOP AFTER INSTALL. (POUNDING CAN CAUSE SPLINTERING, SO SANDING AFTER INSTALLATION IS REQUIRED)
2. FENCE TO BE IN PLACE FOR TWO TO THREE YEARS OR UNTIL PLANTS ARE ESTABLISHED.
3. FENCE TO BE TO THE SATISFACTION OF LANDSCAPE ARCHITECT AND/OR OUSD FACILITIES



STANDARD CLOVE HITCH

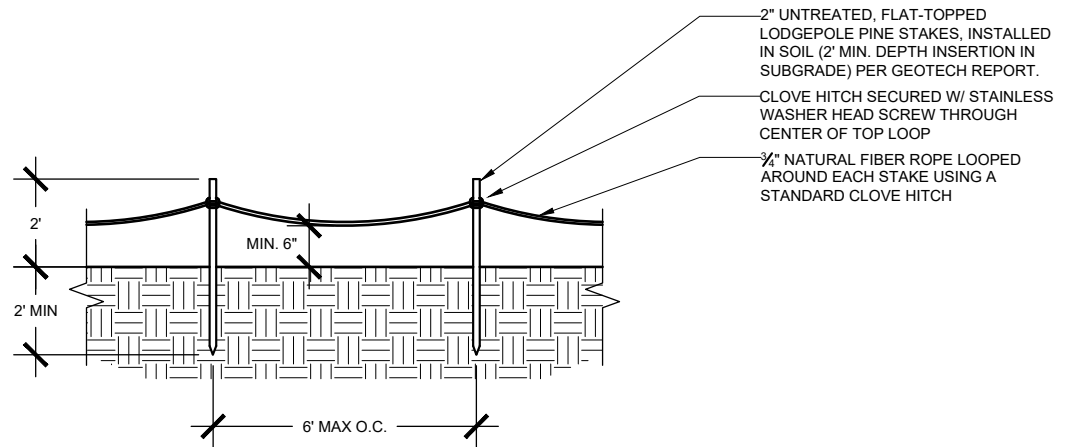

NOT FOR CONSTRUCTION

© THIS DETAIL MAY NOT BE APPLICABLE IN ALL CIRCUMSTANCES AND IS PROVIDED FOR INFORMATIONAL PURPOSES ONLY. SPECIFIC SITE CONDITIONS AND SCHOOL/COMMUNITY REQUIREMENTS MUST BE TAKEN INTO CONSIDERATION. COPYRIGHT RETAINED JOINTLY BY THE OAKLAND UNIFIED SCHOOL DISTRICT AND TRUST FOR PUBLIC LAND. THIS DETAIL IS NOT TO BE REPRODUCED WITHOUT PERMISSION.



**BAY TREE DESIGN**

OUSD LIVING SCHOOLYARD STANDARD DETAILS

DATE: OCTOBER 2022

NOT TO SCALE

DETAIL #



**ESTABLISHMENT FENCE FOR NEW PLANTING AREAS**

**2831.04**



**INTENT AND BENEFITS**

HEALTHY TREES ARE A KEY COMPONENT TO A THRIVING LIVING SCHOOLYARD. TREES ARE CARBON SEQUESTERS, PROVIDE SHADE, FILTER THE AIR, SLOW DOWN RUNOFF FROM RAINSTORM EVENTS, PROVIDE HABITAT FOR BENEFICIAL BIRDS, AND PROVIDE PLAY AND LEARNING OPPORTUNITIES.

**DESIGN NOTES**

1. ALL DIMENSIONS ARE IN FEET AND INCHES. DO NOT SCALE DRAWINGS
2. TREES SHALL BE LOCATED AWAY FROM ANY OBSTACLES TO FUTURE GROWTH OF TREE CROWN, SUCH AS OVERHEAD WIRES OR BUILDING OVERHANG. TREE CROWN SIZE DETERMINED BY 75% OF URBAN FOREST ECOSYSTEM INSTITUTE 'SELECTREE' GUIDE HEIGHT & WIDTH. TRUNK CALIPER TO MEET ANSI Z60.1 CURRENT EDITION FOR ROOT BALL SIZE.
3. BUYING LARGER TREES IN 24-36" BOX CONTAINERS WHERE BUDGET ALLOWS PROVIDE MORE IMMEDIATE RESULTS AND TYPICALLY GREATER CHANCE FOR SUCCESS IN A SCHOOLYARD.

**CONSTRUCTION NOTES**

1. TREE PIT WIDTH SHOULD BE A MINIMUM OF 3 TIMES THE WIDTH OF THE DIAMETER OF THE ROOTBALL. EXCAVATE CIRCULAR PLANTING PITS WITH SIDES SLOPING INWARD AT A 45-DEGREE ANGLE. TRIM PERIMETER OF PIT BOTTOM LEAVING CENTER AREA OF BOTTOM RAISED SLIGHTLY TO SUPPORT ROOTBALL AND ASSIST IN DRAINAGE AWAY FROM CENTER. LOOSEN SIDES OF PLANTING PIT SMOOTHED DURING EXCAVATION.
2. PLANTING PIT SHALL BE AT A DEPTH SO THAT ROOT FLARE TO BE 5 TO 6 INCHES ABOVE ADJACENT FINISHED GRADE IN ALL AREAS THAT WILL BE SHEET MULCHED. WHERE SHEET MULCHING WILL NOT BE USED, THE ROOT FLARE TO BE 4 INCHES ABOVE FINISHED GRADE.
3. BEFORE PLANTING, TEST TREE PITS FOR DRAINAGE. FILL TREE PITS WITH WATER, CHECK HOLES AFTER 24 HOURS. IF WATER HAS NOT DRAINED OUT, SEEK REMEDIAL ACTION. INSTALL DRAINAGE CHIMNEY IF NECESSARY.
4. PERFORM SOIL TEST AND AMMEND AS RECOMMENDED BY QUALIFIED INDIVIDUAL. WHERE ADVISABLE, USE UNAMENDED NATIVE SOIL AS BACKFILL FOR PLANTING CA NATIVE TREES. USE IMPORTED SOIL FOR BACKFILL PER SOIL LAB RECOMMENDATIONS IF PLANTING NON-NATIVE TREES.

5. REMOVE ROOTBALL FROM CONTAINER W/O DAMAGING ROOTBALL OR PLANT. CAREFULLY REMOVE ANY LOOSE SOIL AROUND THE TRUNK. TOP OF ROOTBALL SHOULD NOT BE DISTURBED OR COVERED WITH SOIL.
6. BACKFILL AROUND ROOTBALL IN 6" LIFTS, TAMPING TO SETTLE SOIL AND ELIMINATE AIR POCKETS. WHEN PLANTING PIT IS HALF FILLED, WATER THOROUGHLY BEFORE PLACING REMAINDER OF BACKFILL. REPEAT WATERING UNTIL NO MORE WATER IS ABSORBED. CONTINUE BACKFILL PROCESS TO THE TOP OF ROOT BALL IN 6" LIFTS, WATER AGAIN AFTER PLACING AND TAMPING FINAL LAYER OF SOIL. DO NOT OVER-COMPACT.
7. REMOVE WRAP, TIES, AND NURSERY STAKES FROM TRUNK AFTER TRANSPLANTING APPROVAL AND INSPECT FOR DAMAGE.
8. INSTALL FOUR (4) TREE STAKES AND TIES ONLY TO PROPER LEVEL TO HOLD TREE UPRIGHT. POSITION STRAPS AT POINT WHERE THE TREE WILL SNAP TO UPRIGHT POSITION BY ITSELF WHEN RELEASED IF TOP IS PULLED TO ONE SIDE AS IF WIND LOADED. STAKE TREES TO PROVIDE SUPPORT FOR STRONG WIND EVENTS BUT ALLOW TRUNK MOVEMENT TO STRENGTHEN ROOT SYSTEM AND FLEXIBILITY OF TRUNK. STAKING VARIES BY SPECIES. CONSULT LANDSCAPE ARCHITECT OR ARBORIST. DO NOT PUNCTURE ROOTBALL.
9. REPAIR ALL DAMAGED ADJACENT GRASS WITH SOD. INSTALL MULCH IN MINIMUM 4-FOOT DIAMETER CIRCLE OVER TREE PIT WITH NO MORE THAN 1" MULCH ON TOP OF ROOTBALL. DO NOT MULCH OR COMPOST WITHIN 6 INCHES OF TRUNKS OR STEMS.
10. SPECIFIED DEPTHS OF MULCH, TOPSOIL AND PLANTING SOIL MIX ARE DEPTHS AFTER SETTLEMENT.
11. INSTALL 2 BELOW-GRADE TREE BUBBLERS PER TREE FOR IRRIGATION, ONE ON UPHILL SIDE OF ROOTBALL.
12. CONTINUE TO WATER AND MAINTAIN TREE UNTIL PROJECT TURN-OVER MEETING WITH SCHOOL STAFF. ALL TREE PLANTING TO BE TO THE SATISFACTION OF THE LANDSCAPE ARCHITECT AND/OR OUSD FACILITIES.

**MAINTENANCE NOTES**

1. TREES SHOULD BE MAINTAINED SO AS TO ENCOURAGE INTERACTION, TAKING INTO ACCOUNT THE SCALE OF CHILDREN.

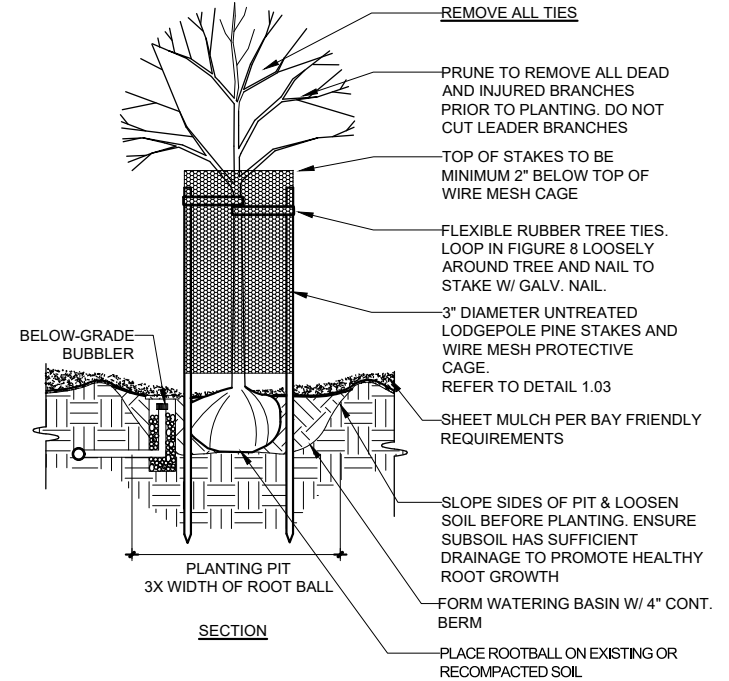

NOT FOR CONSTRUCTION

© THIS DETAIL MAY NOT BE APPLICABLE IN ALL CIRCUMSTANCES AND IS PROVIDED FOR INFORMATIONAL PURPOSES ONLY. SPECIFIC SITE CONDITIONS AND SCHOOL/COMMUNITY REQUIREMENTS MUST BE TAKEN INTO CONSIDERATION. COPYRIGHT RETAINED JOINTLY BY THE OAKLAND UNIFIED SCHOOL DISTRICT AND TRUST FOR PUBLIC LAND. THIS DETAIL IS NOT TO BE REPRODUCED WITHOUT PERMISSION.

<p>OAKLAND UNIFIED SCHOOL DISTRICT Community Learning Through Students</p>	<p><b>BAY TREE DESIGN</b></p>	<p>OUSD LIVING SCHOOLYARD STANDARD DETAILS</p>	<p>DATE: OCTOBER 2022</p>	<p>NOT TO SCALE</p>	<p>DETAIL #</p>
<p>TRUST FOR PUBLIC LAND™</p>			<p><b>TREE PLANTING IN SOFT SURFACE BOX &amp; 15-GAL CONTAINERS</b></p>	<p><b>2900.01</b></p>	

**INTENT & BENEFIT:**

HEALTHY TREES ARE A KEY COMPONENT TO A THRIVING LIVING SCHOOLYARD. TREES ARE CARBON SEQUESTERS, PROVIDE SHADE, FILTER THE AIR, SLOW DOWN RUNOFF FROM RAINSTORM EVENTS, PROVIDE HABITAT FOR BENEFICIAL BIRDS, AND PROVIDE PLAY AND LEARNING OPPORTUNITIES. WHEN PLANTING IN AN AREA SURROUNDED BY HARD SURFACING, ROOTABLE SOIL CONSIDERATIONS ARE KEY TO SUCCESS.

**DESIGN NOTES:**

1. TREES SHALL BE LOCATED AWAY FROM ANY OBSTACLES TO FUTURE GROWTH OF TREE CROWN, SUCH AS OVERHEAD WIRES OR BUILDING OVERHANG. TREE CROWN SIZE DETERMINED BY 75% OF URBAN FOREST ECOSYSTEM INSTITUTE 'SELECTREE' GUIDE HEIGHT & WIDTH. TRUNK CALIPER TO MEET ANSI Z60.1 CURRENT EDITION FOR ROOT BALL SIZE.
2. ROOTABLE SOIL VOLUME WILL VARY PER SIZE OF TREE, CAMPUS LOCATION, URBAN HEAT, WIDTH AND DEPTH. AS A GUIDE, SMALL TREES REQUIRE 800-1200 CF, MEDIUM TREES 1200-1600 CF AND LARGE TREES 1500-200 CF. SEE TREE LIST FOR TREE SIZE CLASSIFICATION.
3. BUYING LARGER TREES IN 24-36" BOX CONTAINERS WHERE BUDGET ALLOWS PROVIDES MORE IMMEDIATE RESULTS AND TYPICALLY GREATER CHANCE FOR SUCCESS IN A SCHOOLYARD.

**CONSTRUCTION NOTES:**

1. TRUNK CALIPER TO MEET ANSI Z60.1 CURRENT EDITION FOR ROOT BALL SIZE.
2. ROOTABLE SOIL VOLUME WILL VARY PER SIZE OF TREE, CAMPUS LOCATION, URBAN HEAT, WIDTH AND DEPTH. AS A GUIDE, SMALL TREES REQUIRE 800-1200 CF, MEDIUM TREES 1200-1600 CF AND LARGE TREES 1500-200 CF. SEE TREE LIST FOR TREE SIZE CLASSIFICATION.
3. EXCAVATE CIRCULAR PLANTING PITS WITH SIDES SLOPING INWARD AT A 45-DEGREE ANGLE. TRIM PERIMETER OF PIT BOTTOM LEAVING CENTER AREA OF BOTTOM RAISED SLIGHTLY TO SUPPORT ROOTBALL AND ASSIST IN DRAINAGE AWAY FROM CENTER. LOOSEN SIDES OF PLANTING PIT SMOOTHED DURING EXCAVATION.
4. PLANTING PIT SHALL BE AT A DEPTH SO THAT ROOT FLARE TO BE 5 TO 6 INCHES ABOVE ADJACENT FINISHED GRADE IN ALL AREAS THAT WILL BE SHEET MULCHED. WHERE SHEET MULCHING WILL NOT BE USED, THE ROOT FLARE TO BE 4 INCHES ABOVE FINISHED GRADE.
5. SOIL COMPACTION RATE TO BE MEASURED IN TWO AREAS AT EACH TREE PLANTING SITE. IF SOIL COMPACTED TO MORE THAN 85%, A QUALIFIED PERSON SHALL SPECIFY AMENDMENTS.
6. BEFORE PLANTING, TEST TREE PITS FOR DRAINAGE. FILL TREE PITS WITH WATER, CHECK HOLES AFTER 24 HOURS. IF WATER HAS NOT DRAINED OUT, SEEK REMEDIAL ACTION. INSTALL DRAINAGE CHIMNEY IF NECESSARY.

7. PERFORM SOIL TEST AND AMMEND AS RECOMMENDED BY QUALIFIED INDIVIDUAL. WHERE ADVISABLE, USE UNAMENDED NATIVE SOIL AS BACKFILL FOR PLANTING CA NATIVE TREES. USE IMPORTED SOIL FOR BACKFILL PER SOIL LAB RECOMMENDATIONS IF PLANTING NON-NATIVE TREES.
8. REMOVE ROOTBALL FROM CONTAINER W/O DAMAGING ROOTBALL OR PLANT. CAREFULLY REMOVE ANY LOOSE SOIL AROUND THE TRUNK. TOP OF ROOTBALL SHOULD NOT BE DISTURBED OR COVERED WITH SOIL.
9. BACKFILL AROUND ROOTBALL IN 6" LIFTS, TAMPING TO SETTLE SOIL AND ELIMINATE AIR POCKETS. WHEN PLANTING PIT IS HALF FILLED, WATER THOROUGHLY. REPEAT WATERING UNTIL NO MORE WATER IS ABSORBED. CONTINUE BACKFILL PROCESS TO THE TOP OF ROOT BALL IN 6" LIFTS, WATER AGAIN AFTER PLACING AND TAMPING FINAL LAYER OF SOIL. DO NOT OVER-COMPACT.
10. REMOVE WRAP, TIES, AND NURSERY STAKES FROM TRUNK AFTER TRANSPLANTING APPROVAL AND INSPECT FOR DAMAGE.
10. INSTALL FOUR TREE STAKES AND TIES ONLY TO PROPER LEVEL TO HOLD TREE UPRIGHT. POSITION STRAPS AT POINT WHERE THE TREE WILL SNAP TO UPRIGHT POSITION BY ITSELF WHEN RELEASED IF TOP IS PULLED TO ONE SIDE AS IF WIND LOADED. STAKE TREES TO PROVIDE SUPPORT FOR STRONG WIND EVENTS BUT ALLOW TRUNK MOVEMENT TO STRENGTHEN ROOT SYSTEM AND FLEXIBILITY OF TRUNK. STAKING VARIES BY SPECIES. CONSULT LANDSCAPE ARCHITECT OR ADBORIST. DO NOT PUNCTURE ROOTBALL.
11. REPAIR ALL DAMAGED ADJACENT GRASS WITH SOD. INSTALL MULCH IN MINIMUM 4-FOOT DIAMETER CIRCLE OVER TREE PIT WITH NO MORE THAN 1" MULCH ON TOP OF ROOTBALL. DO NOT MULCH OR COMPOST WITHIN 6 INCHES OF TRUNKS OR STEMS.
12. SPECIFIED DEPTHS OF MULCH, TOPSOIL AND PLANTING SOIL MIX ARE DEPTHS AFTER SETTLEMENT.
13. INSTALL 2 BELOW-GRADE TREE BUBBLERS PER TREE FOR IRRIGATION, ONE ON UPHILL SIDE OF ROOTBALL.
14. PRUNE BRANCHES TO HEIGHT THAT CONSIDERS FUNCTION OF SPACE AND SCALE OF CHILDREN. LOWER BRANCHES PROVIDE OPPORTUNITIES FOR INTERACTION AND SHADED AREAS.
15. CONTINUE TO WATER AND MAINTAIN TREE UNTIL PROJECT TURN-OVER MEETING WITH SCHOOL STAFF. ALL TREE PLANTING TO BE TO THE SATISFACTION OF THE LANDSCAPE ARCHITECT AND/OR OUSD FACILITIES.
16. CONTINUE TO WATER AND MAINTAIN TREE UNTIL PROJECT TURN-OVER MEETING WITH SCHOOL STAFF. ALL TREE PLANTING TO BE TO THE SATISFACTION OF THE LANDSCAPE ARCHITECT AND/OR OUSD FACILITIES.

**MAINTENANCE NOTES:**

1. PRUNE BRANCHES TO HEIGHT THAT CONSIDERS FUNCTION OF SPACE AND SCALE OF CHILDREN. LOWER BRANCHES PROVIDE OPPORTUNITIES FOR INTERACTION AND SHADED AREAS.

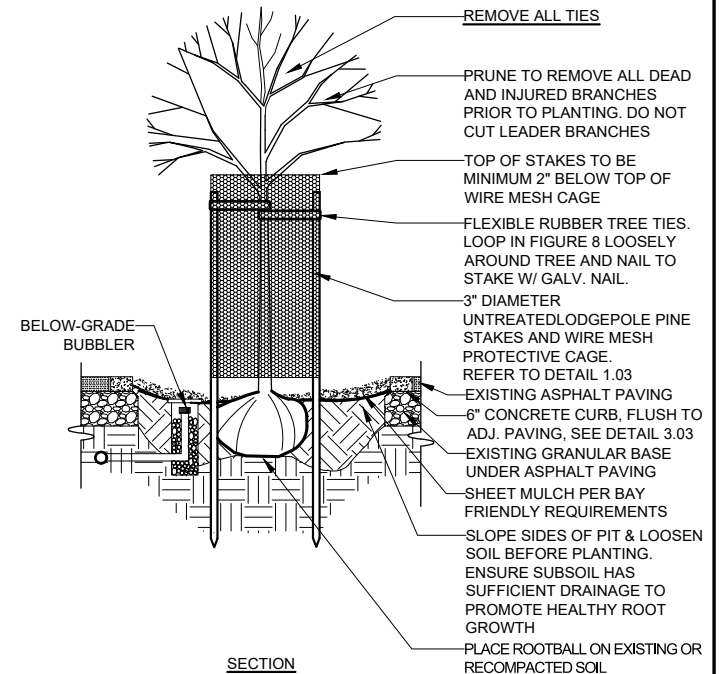

NOT FOR CONSTRUCTION



THIS DETAIL MAY NOT BE APPLICABLE IN ALL CIRCUMSTANCES AND IS PROVIDED FOR INFORMATIONAL PURPOSES ONLY. SPECIFIC SITE CONDITIONS AND SCHOOL/COMMUNITY REQUIREMENTS MUST BE TAKEN INTO CONSIDERATION. COPYRIGHT RETAINED JOINTLY BY THE OAKLAND UNIFIED SCHOOL DISTRICT AND TRUST FOR PUBLIC LAND. THIS DETAIL IS NOT TO BE REPRODUCED WITHOUT PERMISSION.



**BAY TREE DESIGN**

OUSD LIVING SCHOOLYARD STANDARD DETAILS

DATE: OCTOBER 2022

NOT TO SCALE

DETAIL #



**TREE PLANTING IN HARD SURFACE BOX AND 15-GAL CONTAINERS**

**2900.02**

**INTENT & BENEFIT:**

NEWLY PLANTED TREES REQUIRE PROTECTION UNTIL THEY ARE ROBUST ENOUGH TO WITHSTAND WIND PRESSURE AND THE ACTIVITIES IN THE SCHOOLYARD.

**DESIGN NOTES:**

1. TREE PROTECTION MEASURES GENERALLY ONLY NECESSARY INSIDE THE SCHOOLYARD.

**CONSTRUCTION NOTES:**

1. LODGEPOLE PINE STAKES TO BE DRIVEN INTO SUBGRADE OUTSIDE THE ROOTBALL PRIOR TO BACKFILLING (MIN 18" DEPTH).
2. LOOP NON-ABRASIVE RUBBER TREE TIES IN FIGURE 8 LOOSELY AROUND TREE AND NAIL TO STAKE WITH GALVANIZED NAIL. TO BE LOWERED AFTER 1 YEAR AND REMOVED AFTER 2 YEARS TO ENCOURAGE STRONG ROOT SYSTEMS.
3. TOP OF STAKES TO BE MIN. 2" BELOW TOP OF WIRE MESH CAGE.
4. 12.5-GAUGE (2"X2") GALVANIZED WELDED WIRE MESH; NAIL TO LODGEPOLES WITH 3/8" U FENCING NAILS; TURN WIRE ENDS INWARD.
5. ENSURE WIRE MESH 6" BELOW BRANCHES.
6. ENSURE 6" GAP BETWEEN WIRE MESH AND FINISHED GRADE OF SURFACE TREATMENT.
7. INSTALL WIRE MESH WITH HORIZONTAL WIRES ON THE OUTSIDE OF THE CAGE.
8. DO NOT USE GALVANIZED STEEL MESH FOR FRUIT TREES.
9. ALL PROTECTIVE TREE CAGES TO BE TO THE SATISFACTION OF THE LANDSCAPE ARCHITECT AND/OR OUSD FACILITIES.

**MAINTENANCE NOTES:**

1. WIRE MESH PROTECTIVE TREE CAGE TO REMAIN IN PLACE FOR FIVE (5) YEARS OR UNTIL TREE IS FULLY ESTABLISHED, WHICHEVER OCCURS FIRST.

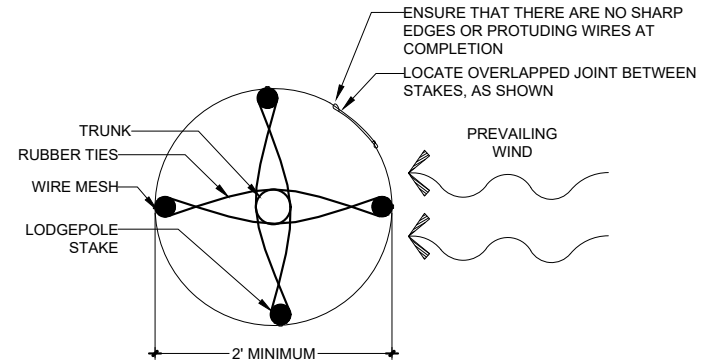

PLAN

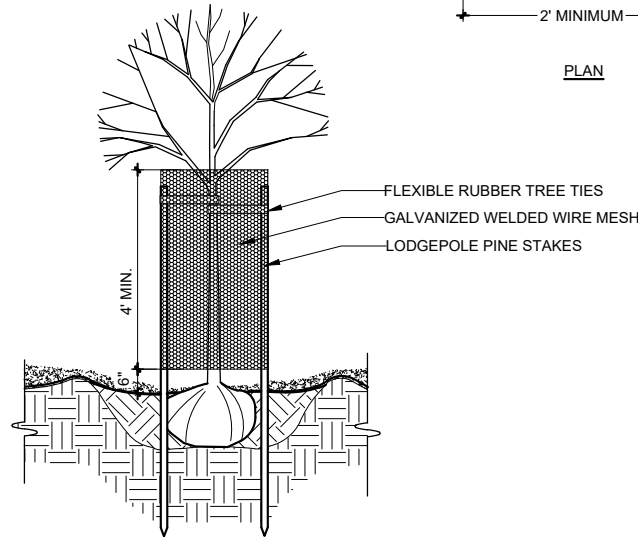



SECTION

NOT FOR CONSTRUCTION



THIS DETAIL MAY NOT BE APPLICABLE IN ALL CIRCUMSTANCES AND IS PROVIDED FOR INFORMATIONAL PURPOSES ONLY. SPECIFIC SITE CONDITIONS AND SCHOOL/COMMUNITY REQUIREMENTS MUST BE TAKEN INTO CONSIDERATION. COPYRIGHT RETAINED JOINTLY BY THE OAKLAND UNIFIED SCHOOL DISTRICT AND TRUST FOR PUBLIC LAND. THIS DETAIL IS NOT TO BE REPRODUCED WITHOUT PERMISSION.

		OUSD LIVING SCHOOLYARD STANDARD DETAILS	DATE: OCTOBER 2022	NOT TO SCALE	DETAIL #
			<h1>TREE PROTECTION</h1>		<h1>2900.03</h1>

**INTENT AND BENEFIT:**

SIMILAR TO TREES, LARGE SHRUBS PROVIDE MANY BENEFITS TO A LIVING SCHOOL YARD. SHRUBS ARE CARBON SEQUESTERS, FILTER THE AIR, SLOW DOWN RUNOFF FROM RAINSTORM EVENTS, PROVIDE HABITAT FOR BENEFICIAL BIRDS, AND PROVIDE PLAY AND LEARNING OPPORTUNITIES.

**DESIGN NOTES:**

1. PLANTS SHALL BE CHOSEN FOR THEIR ABILITY TO THRIVE, PROVIDE INTENDED BENEFIT, AND IN CONSIDERATION OF ADJACENT USES.
2. SITUATE PLANTS SO AS TO PROVIDE CLEAR SITE LINES TO MAIN AREAS USED BY CHILDREN. TALLER SHRUBS THAT NATURALLY GROW IN A VASE SHAPE ARE IDEAL.
3. ALLOW AMPLY SPACE FOR PLANTINGS SUCH THAT THEY WILL NOT REQUIRE PRUNING.
4. SELECT PLANTS TO WORK WITH MWEL0.

**CONSTRUCTION NOTES:**

1. PRUNE TO REMOVE ALL DEAD AND INJURED BRANCHES PRIOR TO PLANTING. PRUNE TO REMOVE ALL CROSSING AND OVERLAPPING BRANCHES. PRUNE TO REMOVE ALL SIDE SHOOTS TO 3' ABOVE NEW FINISHED GRADE. ALL PRUNING TO BE TO BEST ARBORICULTURAL PRACTICE. ALL CUTS TO BE MADE AT NARROWEST PART OF BRANCH (DO NOT DAMAGE BRANCH COLLAR) USING CLEAN AND SHARP TOOLS.
2. CAREFULLY REMOVE ANY LOOSE SOIL AROUND TRUNK. TOP OF ROOTBALL SHOULD NOT BE DISTURBED OR COVERED WITH SOIL.
3. PLANT MULTI-STEM SHRUBS WITH TOP OF ROOTBALL AT EXISTING GRADE.
4. BACKFILL AROUND ROOTBALL IN 6" LIFTS, TAMPING TO SETTLE SOIL AND ELIMINATE AIR POCKETS. WHEN PLANTING PIT IS HALF FILLED, WATER THOROUGHLY BEFORE PLACING REMAINDER OF BACKFILL IN 6" LIFTS. REPEAT WATERING UNTIL NO MORE WATER IS ABSORBED. CONTINUE BACKFILL PROCESS TO THE TOP OF ROOT BALL, WATER AGAIN AFTER PLACING AND TAMPING FINAL LAYER OF SOIL. DO NOT OVER-COMPACT.
5. SPECIFIED DEPTHS OF MULCH, TOPSOIL AND PLANTING SOIL MIX ARE DEPTHS AFTER SETTLEMENT
6. REMOVE ANY WRAP AND TIES FROM TRUNKS AND INSPECT FOR DAMAGE.
7. WATER THOROUGHLY AFTER INSTALLATION AND UNTIL PROJECT TURN-OVER MEETING WITH SCHOOL STAFF.
8. INSTALL 1 TREE BUBBLER PER SHRUB FOR IRRIGATION ON UPHILL SIDE OF ROOTBALL.
9. ALL SHRUB PLANTINGS TO BE TO THE SATISFACTION OF THE LANDSCAPE ARCHITECT AND/OR OUSD FACILITIES.

**MAINTENANCE NOTES:**

1. ONLY PRUNE SHRUBS WHEN NECESSARY

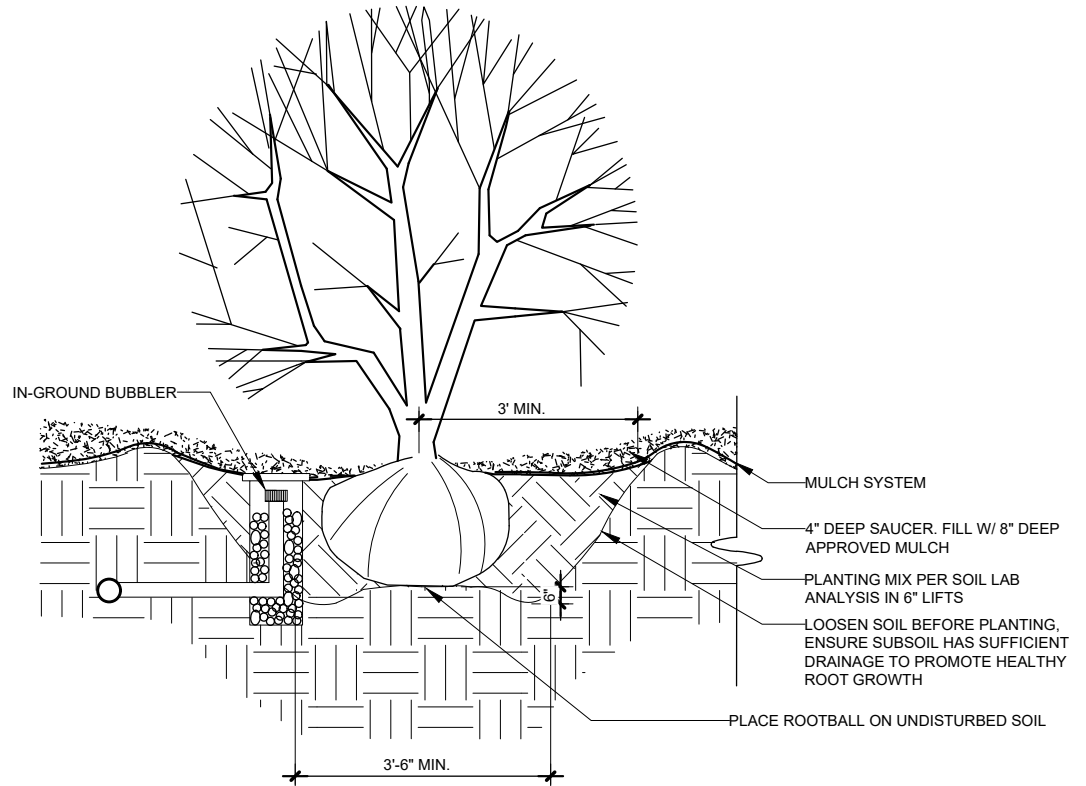

NOT FOR CONSTRUCTION



THIS DETAIL MAY NOT BE APPLICABLE IN ALL CIRCUMSTANCES AND IS PROVIDED FOR INFORMATIONAL PURPOSES ONLY. SPECIFIC SITE CONDITIONS AND SCHOOL/COMMUNITY REQUIREMENTS MUST BE TAKEN INTO CONSIDERATION. COPYRIGHT RETAINED JOINTLY BY THE OAKLAND UNIFIED SCHOOL DISTRICT AND TRUST FOR PUBLIC LAND. THIS DETAIL IS NOT TO BE REPRODUCED WITHOUT PERMISSION.



**BAY TREE DESIGN**

OUSD LIVING SCHOOLYARD STANDARD DETAILS

DATE: OCTOBER 2022

NOT TO SCALE

DETAIL #



**SHRUB PLANTING**  
**15-GAL & 5-GAL CONTAINERS**

**2900.04**

**INTENT & BENEFIT:**

BACKFLOW PREVENTION IS A CRITICAL COMPONENT OF THE IRRIGATION SYSTEM FOR THE HEALTH AND SAFETY OF THE CHILDREN AND ADULTS ON CAMPUS. BACKFLOW PREVENTION PROTECTS THE POTABLE WATER SUPPLY FROM CONTAMINANTS AND POLLUTANTS BEING INTRODUCED INTO THE PORTABLE/DRINKING WATER SYSTEM. THIS DETAIL PROVIDES AN APPROVED INSTALLATION METHOD FOR THE BACKFLOW ASSEMBLY.

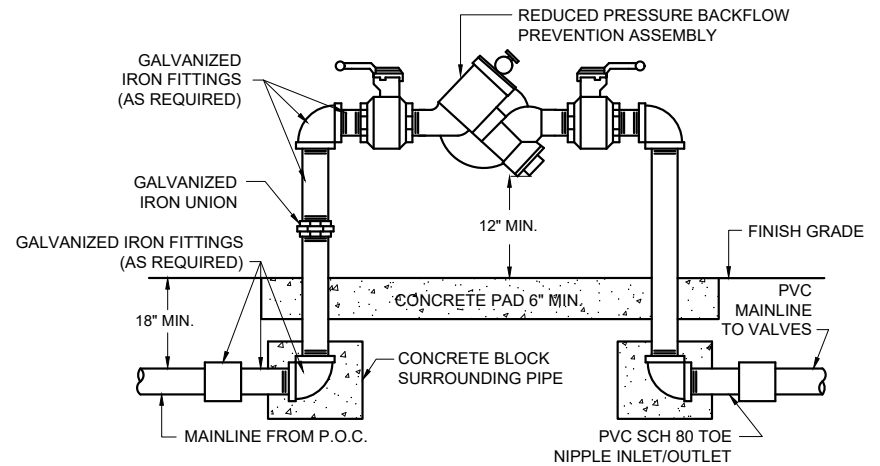

**NOTES:**

1. EVENLY COAT METAL FITTINGS EXPOSED TO SOIL AND CONCRETE WITH 3M SCOTCHRAP PIPE PRIMER AND THEN WRAP WITH 3M SCOTCHRAP NO. 51 BLACK TAPE (3/4" OVERLAP). USE DIELECTRIC FITTINGS WHERE DISSIMILAR METALS COME INTO CONTACT.
2. LOCAL CODES SHALL GOVERN THE INSTALLATION REQUIREMENTS.
3. BACKFLOW PREVENTER SHALL BE INSTALLED A MINIMUM OF 12" AND A MAXIMUM OF 30" FROM BOTTOM OF DEVICE TO FINISH GRADE.
4. REFER TO BACKFLOW ENCLOSURE DETAIL 6.02 FOR CONCRETE PAD DIMENSIONS.



NOT FOR CONSTRUCTION

© THIS DETAIL MAY NOT BE APPLICABLE IN ALL CIRCUMSTANCES AND IS PROVIDED FOR INFORMATIONAL PURPOSES ONLY. SPECIFIC SITE CONDITIONS AND SCHOOL/COMMUNITY REQUIREMENTS MUST BE TAKEN INTO CONSIDERATION. COPYRIGHT RETAINED JOINTLY BY THE OAKLAND UNIFIED SCHOOL DISTRICT AND TRUST FOR PUBLIC LAND. THIS DETAIL IS NOT TO BE REPRODUCED WITHOUT PERMISSION.

 <p>OAKLAND UNIFIED SCHOOL DISTRICT Community Learning Through Standards</p>	<p><b>BAY TREE DESIGN</b></p>	<p>OUSD LIVING SCHOOLYARD STANDARD DETAILS</p>	<p>DATE: OCTOBER 2022</p>	<p>NOT TO SCALE</p>	<p>DETAIL #</p>
 <p>TRUST FOR PUBLIC LAND™</p>	 <p>BROOKWATER</p>		<p><b>REDUCED PRESSURE BACKFLOW ASSEMBLY - 2" AND SMALLER</b></p>	<p><b>2900.05</b></p>	

**INTENT & BENEFIT:**

A BACKFLOW ENCLOSURE PROTECTS THE BACKFLOW ASSEMBLY FROM VANDALISM AND THEFT. IT ALSO PROTECTS THE CHILDREN FROM FALLING ONTO THE BACKFLOW DEVICE. THE ENCLOSURE HAS ROUNDED METAL SUPPORTS WITH NO SHARP CORNERS OR EDGES SO IT'S PERFECT FOR SCHOOLS AND PARKS.

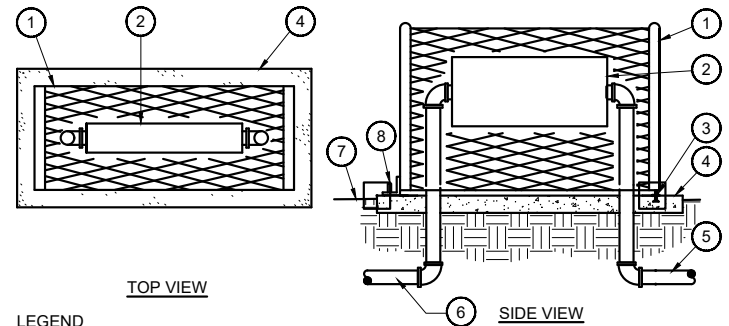

- LEGEND**
- |   |  |
|---|--|
| 1. METAL BACKFLOW ENCLOSURE.  | 5. MAINLINE TO VALVES.                               |
| 2. BACKFLOW PREVENTER.  | 6. MAINLINE FROM POINT OF CONNECTION OR WATER METER. |
| 3. HOLD DOWN ASSEMBLY (TYPICAL).  | 7. FINISH GRADE.                                     |
| 4. POURED CONCRETE BASE. - 6" MINIMUM THICKNESS - EXTEND 4" BEYOND OUTSIDE DIMENSIONS OF ENCLOSURE. | 8. SUPPORT ROD (TYPICAL).                            |

NOT FOR CONSTRUCTION

© THIS DETAIL MAY NOT BE APPLICABLE IN ALL CIRCUMSTANCES AND IS PROVIDED FOR INFORMATIONAL PURPOSES ONLY. SPECIFIC SITE CONDITIONS AND SCHOOL/COMMUNITY REQUIREMENTS MUST BE TAKEN INTO CONSIDERATION. COPYRIGHT RETAINED JOINTLY BY THE OAKLAND UNIFIED SCHOOL DISTRICT AND TRUST FOR PUBLIC LAND. THIS DETAIL IS NOT TO BE REPRODUCED WITHOUT PERMISSION.

<p>OAKLAND UNIFIED SCHOOL DISTRICT Community Learning Through Students</p>	<p>BAY TREE DESIGN</p>	<p>OUSD LIVING SCHOOLYARD STANDARD DETAILS</p>	DATE: OCTOBER 2022	NOT TO SCALE	DETAIL #
			<p><b>BACKFLOW ENCLOSURE</b></p>		<p><b>2900.06</b></p>
<p>TRUST FOR PUBLIC LAND™</p>	<p>BROOKWATER</p>				

**INTENT & BENEFIT:**

THE IRRIGATION CONTROLLER IS WEATHER BASED TO CONSERVE WATER. AS WATER IS ONE OF OUR MOST VALUABLE RESOURCES, THE PROPER CONTROL SYSTEM IS ESSENTIAL FOR A WATER CONSERVING IRRIGATION SYSTEM. THE CONTROLLER WILL AUTOMATICALLY ADJUST THE WATERING SCHEDULE BASED ON WEATHER.

**WIRE CONDUIT SIZING**

- 1-9 WIRES = 1" CONDUIT
- 10-16 WIRES = 1 1/4" CONDUIT
- 17-23 WIRES = 1 1/2" CONDUIT
- 24-38 WIRES = 2" CONDUIT
- 39-54 WIRES = 2 1/2" CONDUIT

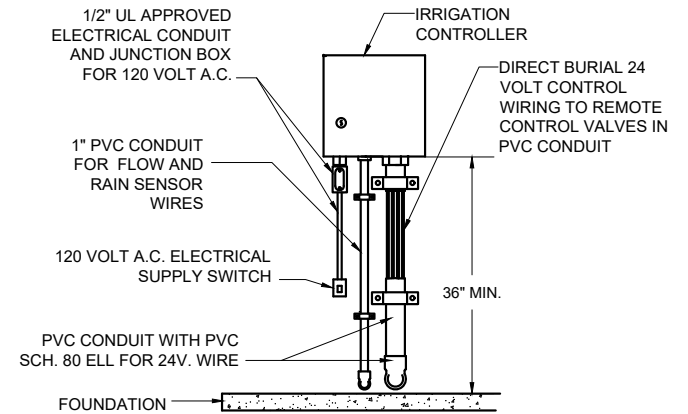

NOT FOR CONSTRUCTION

© THIS DETAIL MAY NOT BE APPLICABLE IN ALL CIRCUMSTANCES AND IS PROVIDED FOR INFORMATIONAL PURPOSES ONLY. SPECIFIC SITE CONDITIONS AND SCHOOL/COMMUNITY REQUIREMENTS MUST BE TAKEN INTO CONSIDERATION. COPYRIGHT RETAINED JOINTLY BY THE OAKLAND UNIFIED SCHOOL DISTRICT AND TRUST FOR PUBLIC LAND. THIS DETAIL IS NOT TO BE REPRODUCED WITHOUT PERMISSION.

 <p>OAKLAND UNIFIED SCHOOL DISTRICT Community Learning Through Students</p>	<p><b>BAY TREE DESIGN</b></p>	<p>OUSD LIVING SCHOOLYARD STANDARD DETAILS</p>	<p>DATE: OCTOBER 2022</p>	<p>NOT TO SCALE</p>	<p>DETAIL #</p>
 <p>TRUST FOR PUBLIC LAND™</p>	 <p>BROOKWATER</p>		<p><b>IRRIGATION CONTROLLER - INSIDE WALL MOUNT</b></p>	<p><b>2900.07</b></p>	

**INTENT & BENEFIT:**

THE IRRIGATION CONTROLLER IS WEATHER BASED TO CONSERVE WATER. AS WATER IS ONE OF OUR MOST VALUABLE RESOURCES, THE PROPER CONTROL SYSTEM IS ESSENTIAL FOR A WATER CONSERVING IRRIGATION SYSTEM. THE CONTROLLER WILL AUTOMATICALLY ADJUST THE WATERING SCHEDULE BASED ON WEATHER.

**WIRE CONDUIT SIZING**

- 1-9 WIRES = 1" CONDUIT
- 10-16 WIRES = 1 1/4" CONDUIT
- 17-23 WIRES = 1 1/2" CONDUIT
- 24-38 WIRES = 2" CONDUIT
- 39-54 WIRES = 2 1/2" CONDUIT

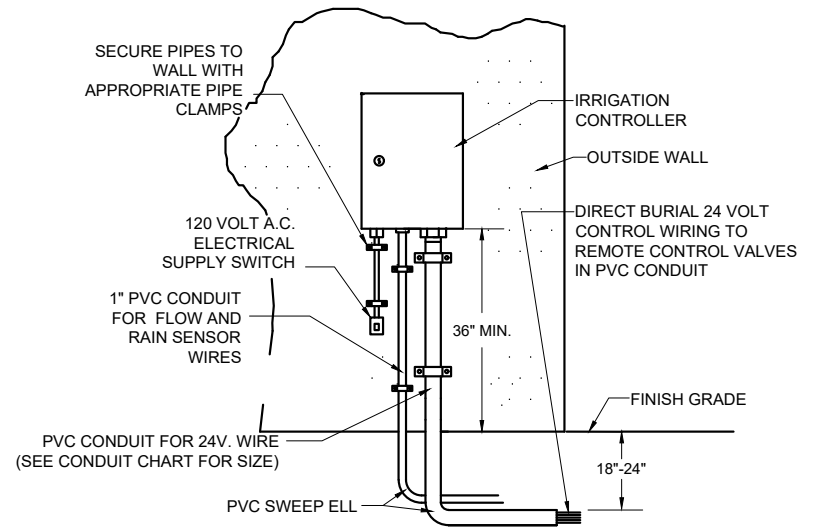

NOT FOR CONSTRUCTION

© THIS DETAIL MAY NOT BE APPLICABLE IN ALL CIRCUMSTANCES AND IS PROVIDED FOR INFORMATIONAL PURPOSES ONLY. SPECIFIC SITE CONDITIONS AND SCHOOL/COMMUNITY REQUIREMENTS MUST BE TAKEN INTO CONSIDERATION. COPYRIGHT RETAINED JOINTLY BY THE OAKLAND UNIFIED SCHOOL DISTRICT AND TRUST FOR PUBLIC LAND. THIS DETAIL IS NOT TO BE REPRODUCED WITHOUT PERMISSION.

 <p>OAKLAND UNIFIED SCHOOL DISTRICT Community Learning Through Students</p>	<p><b>BAY TREE DESIGN</b></p>	<p>OUSD LIVING SCHOOLYARD STANDARD DETAILS</p>	<p>DATE: OCTOBER 2022</p>	<p>NOT TO SCALE</p>	<p>DETAIL #</p>
 <p>TRUST FOR PUBLIC LAND™</p>	 <p>BROOKWATER</p>		<p><b>IRRIGATION CONTROLLER - OUTSIDE WALL MOUNT</b></p>	<p><b>2900.08</b></p>	





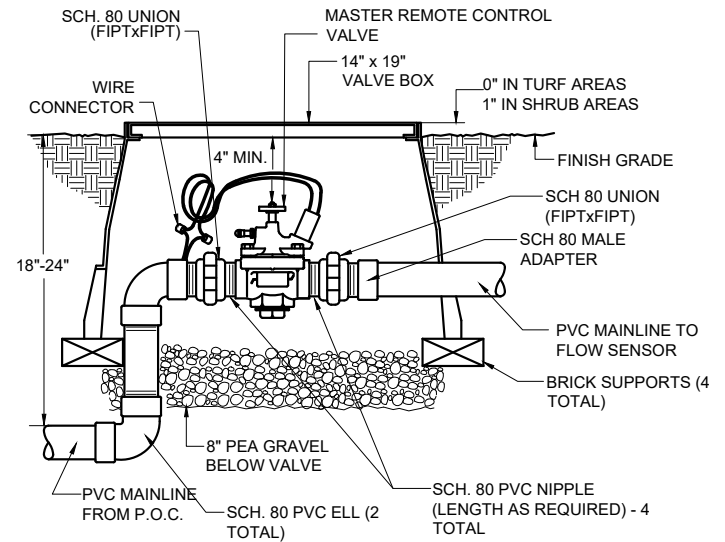

**INTENT & BENEFIT:**

A MASTER CONTROL VALVE IS USED TO CONTROL THE ENTIRE IRRIGATION SYSTEM. THIS MASTER VALVE IS INSTALLED DOWNSTREAM OF THE BACKFLOW PREVENTER AND IS CONNECTED TO THE CONTROLLER. IF A LEAK IN THE MAINLINE OCCURS, THE CONTROLLER WILL SENSE THE INCREASE IN WATER VIA A FLOW SENSOR, AND THE MASTER VALVE WILL CLOSE, STOPPING WATER FROM ENTERING THE SYSTEM. THIS IS BENEFICIAL IN CONSERVING WATER THROUGH LEAKS. THE MASTER VALVE CAN ALSO DETECT ZONE VALVE MALFUNCTION AND ALERT THE USER.



NOT FOR CONSTRUCTION

© THIS DETAIL MAY NOT BE APPLICABLE IN ALL CIRCUMSTANCES AND IS PROVIDED FOR INFORMATIONAL PURPOSES ONLY. SPECIFIC SITE CONDITIONS AND SCHOOL/COMMUNITY REQUIREMENTS MUST BE TAKEN INTO CONSIDERATION. COPYRIGHT RETAINED JOINTLY BY THE OAKLAND UNIFIED SCHOOL DISTRICT AND TRUST FOR PUBLIC LAND. THIS DETAIL IS NOT TO BE REPRODUCED WITHOUT PERMISSION.

 	 	OUSD LIVING SCHOOLYARD STANDARD DETAILS	DATE: OCTOBER 2022	NOT TO SCALE	DETAIL #
			<h2 style="margin: 0;">MASTER CONTROL VALVE</h2>		

**INTENT & BENEFIT:**

A FLOW SENSOR DETECTS WATER FLOW THROUGH THE IRRIGATION SYSTEM AND TRANSMITS A SIGNAL TO THE CONTROLLER. IT CAN USE THAT INFORMATION TO DETECT UNSCHEDULED LOW OR HIGH FLOW EVENTS. IF THERE IS A LEAK AND TOO MUCH FLOW IS DETECTED, THE FLOW SENSOR SENDS AN SIGNAL TO THE CONTROLLER AND THE CONTROLLER WILL SHUT OFF THE MASTER VALVE, SAVING WATER. IF THERE IS A LOW FLOW EVENT (SUCH AS A VALVE THAT DOES NOT COME ON), THE SENSOR WILL ALERT THE CONTROLLER AND THE CONTROLLER WILL ALERT THE USER. THIS DEVICE CAN SAVE WATER AND PLANT MATERIAL.

**NOTES:**

1. FLOW SENSOR MUST BE INSTALLED WITH INSERT (TOP) VERTICAL AND BODY (TEE) POSITIONED HORIZONTALLY.
2. THE UNOBSTRUCTED STRAIGHT PIPE LENGTH UPSTREAM OF THE FLOW SENSOR SHALL BE 10 TIMES THE FLOW SENSOR SIZE. (IE. A 2" FLOW SENSOR WILL HAVE A PIPE LENGTH OF 20").
3. THE UNOBSTRUCTED STRAIGHT PIPE LENGTH DOWNSTREAM OF THE FLOW SENSOR SHALL BE 5 TIMES THE FLOW SENSOR SIZE. (IE. A 2" FLOW SENSOR WILL HAVE A PIPE LENGTH OF 10").
4. THE ABOVE PIPE LENGTHS SHALL BE FREE OF ANY VALVES, FITTINGS, OR PIPE BENDS.
5. USE ONLY MANUFACTURER APPROVED SHIELDED FLOW SENSOR CABLE. THE CABLE SHALL BE INSTALLED IN A SEPARATE 1" CONDUIT FROM THE SENSOR TO THE CONTROLLER. ALLOW ENOUGH FLEXIBILITY IN THE CABLE TO ALLOW FOR FUTURE SERVICE OF THE SENSOR.
- 6.

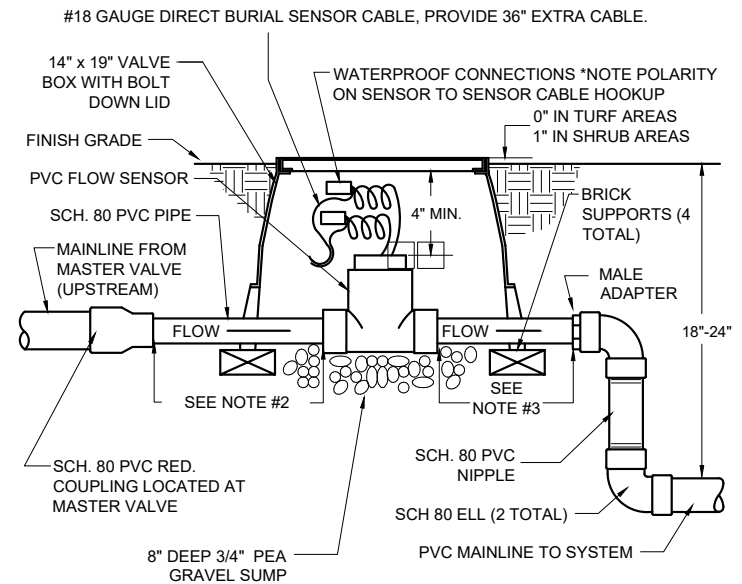

NOT FOR CONSTRUCTION

© THIS DETAIL MAY NOT BE APPLICABLE IN ALL CIRCUMSTANCES AND IS PROVIDED FOR INFORMATIONAL PURPOSES ONLY. SPECIFIC SITE CONDITIONS AND SCHOOL/COMMUNITY REQUIREMENTS MUST BE TAKEN INTO CONSIDERATION. COPYRIGHT RETAINED JOINTLY BY THE OAKLAND UNIFIED SCHOOL DISTRICT AND TRUST FOR PUBLIC LAND. THIS DETAIL IS NOT TO BE REPRODUCED WITHOUT PERMISSION.

<p>OAKLAND UNIFIED SCHOOL DISTRICT Community Schools Through Students</p>	<p>BAY TREE DESIGN</p>	<p>OUSD LIVING SCHOOLYARD STANDARD DETAILS</p>	DATE: OCTOBER 2022	NOT TO SCALE	DETAIL #
			<h1>FLOW SENSOR</h1>		<h2>2900.10</h2>
<p>TRUST FOR PUBLIC LAND™</p>	<p>BROOKWATER</p>				

**INTENT & BENEFIT:**

A REMOTE CONTROL VALVE IS USED TO TURN THE IRRIGATION ZONE ON AND OFF. THE VALVE IS CONTROLLED BY THE IRRIGATION CONTROLLER. A BALL VALVE IS INSTALLED UPSTREAM OF THE VALVE TO ALLOW FOR EASY REPAIRS.



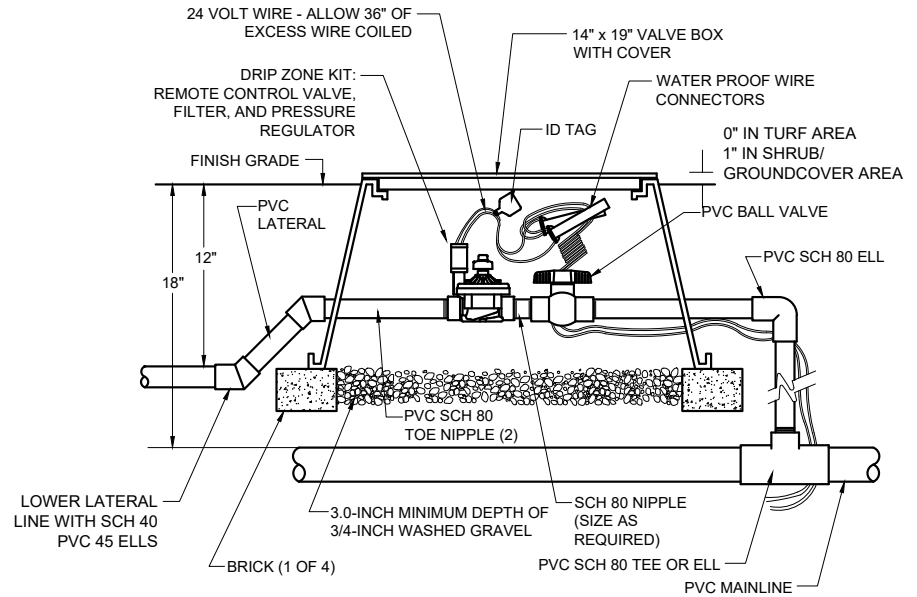

**NOTES:**

1. WIRE CONNECTORS SHALL BE 3M DBY WATERPROOF CONNECTORS OR EQUAL.
2. CONTROL WIRE SHALL BE #14 GAUGE AND COMMON WIRE SHALL BE #12 GAUGE APPROVED FOR DIRECT BURIAL.
3. ID TAGS SHALL DENOTE THE CONTROLLER LETTER AND STATION NUMBER. THE TAGS SHALL BE WATERPROOF.
4. LIMIT OF ONE VALVE PER VALVE BOX.
5. THOROUGHLY FLUSH THE MAINLINE PRIOR TO INSTALLING THE VALVES.



NOT FOR CONSTRUCTION

© THIS DETAIL MAY NOT BE APPLICABLE IN ALL CIRCUMSTANCES AND IS PROVIDED FOR INFORMATIONAL PURPOSES ONLY. SPECIFIC SITE CONDITIONS AND SCHOOL/COMMUNITY REQUIREMENTS MUST BE TAKEN INTO CONSIDERATION. COPYRIGHT RETAINED JOINTLY BY THE OAKLAND UNIFIED SCHOOL DISTRICT AND TRUST FOR PUBLIC LAND. THIS DETAIL IS NOT TO BE REPRODUCED WITHOUT PERMISSION.

 	 	OUSD LIVING SCHOOLYARD STANDARD DETAILS	DATE: OCTOBER 2022	NOT TO SCALE	DETAIL #
			<h2>REMOTE CONTROL VALVE</h2>		

**INTENT & BENEFIT:**

A DRIP ZONE KIT CONSISTS OF A REMOTE CONTROL VALVE, WYE FILTER, AND PRESET PRESSURE REGULATOR. A BALL VALVE IS INSTALLED UPSTREAM OF THE VALVE TO ALLOW FOR EASY REPAIRS. THIS VALVE IS USED FOR DRIP ZONES ONLY.

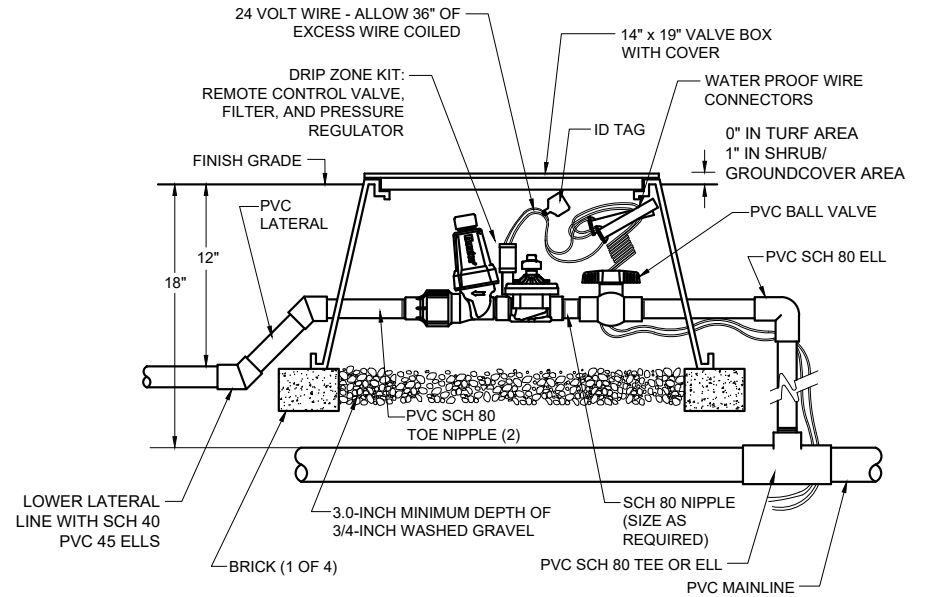

**NOTES:**

1. WIRE CONNECTORS SHALL BE 3M DBY WATERPROOF CONNECTORS OR EQUAL.
2. CONTROL WIRE SHALL BE #14 GAUGE AND COMMON WIRE SHALL BE #12 GAUGE APPROVED FOR DIRECT BURIAL.
3. ID TAGS SHALL DENOTE THE CONTROLLER LETTER AND STATION NUMBER. THE TAGS SHALL BE WATERPROOF.
4. LIMIT OF ONE VALVE PER VALVE BOX.
5. THOROUGHLY FLUSH THE MAINLINE PRIOR TO INSTALLING THE VALVES.



NOT FOR CONSTRUCTION

© THIS DETAIL MAY NOT BE APPLICABLE IN ALL CIRCUMSTANCES AND IS PROVIDED FOR INFORMATIONAL PURPOSES ONLY. SPECIFIC SITE CONDITIONS AND SCHOOL/COMMUNITY REQUIREMENTS MUST BE TAKEN INTO CONSIDERATION. COPYRIGHT RETAINED JOINTLY BY THE OAKLAND UNIFIED SCHOOL DISTRICT AND TRUST FOR PUBLIC LAND. THIS DETAIL IS NOT TO BE REPRODUCED WITHOUT PERMISSION.

		OUSD LIVING SCHOOLYARD STANDARD DETAILS	DATE: OCTOBER 2022	NOT TO SCALE	DETAIL #
			<h2 style="margin: 0;">DRIP ZONE KIT</h2>		2900.12



**INTENT & BENEFIT:**

VALVE BOXES ARE USED TO PROTECT THE VALVE ASSEMBLIES AND FOR EASY ACCESS TO VALVE REPAIR.

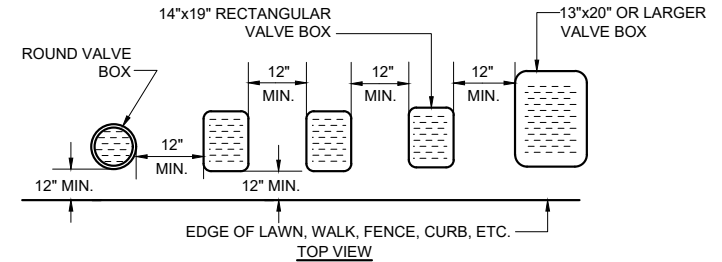

**NOTES:**

1. CENTER BOX OVER VALVE TO FACILITATE SERVICING VALVE.
2. SET BOXES 1" ABOVE FINISH GRADE OR MULCH COVER IN GROUND COVER/SHRUB AREA AND FLUSH WITH FINISH GRADE IN TURF AREA.
3. SET VALVE BOX ASSEMBLY IN GROUND COVER/SHRUB AREA WHERE POSSIBLE. INSTALL IN LAWN AREA ONLY IF GROUND COVER/SHRUB AREA DOES NOT EXIST ADJACENT TO LAWN.
4. SET BOXES PARALLEL TO EACH OTHER AND PERPENDICULAR TO EDGE.
5. AVOID HEAVILY COMPACTING SOIL AROUND VALVE BOX EDGES TO PREVENT COLLAPSE AND DEFORMATION OF VALVE BOX SIDES.
6. VALVE BOXES SHALL HAVE BOLT DOWN LIDS WITH BOLTS INSTALLED.
7. VALVE BOXES SHALL BE BY NDS PRO SERIES, CARSON, OR EQUAL.



NOT FOR CONSTRUCTION

© THIS DETAIL MAY NOT BE APPLICABLE IN ALL CIRCUMSTANCES AND IS PROVIDED FOR INFORMATIONAL PURPOSES ONLY. SPECIFIC SITE CONDITIONS AND SCHOOL/COMMUNITY REQUIREMENTS MUST BE TAKEN INTO CONSIDERATION. COPYRIGHT RETAINED JOINTLY BY THE OAKLAND UNIFIED SCHOOL DISTRICT AND TRUST FOR PUBLIC LAND. THIS DETAIL IS NOT TO BE REPRODUCED WITHOUT PERMISSION.

 <p>OAKLAND UNIFIED SCHOOL DISTRICT Community Schools. Strong Students.</p>	<p><b>BAY TREE DESIGN</b></p>	<p>OUSD LIVING SCHOOLYARD STANDARD DETAILS</p>	<p>DATE: OCTOBER 2022</p>	<p>NOT TO SCALE</p>	<p>DETAIL #</p>
 <p>TRUST FOR PUBLIC LAND™</p>	 <p>BROOKWATER</p>		<p><b>VALVE BOX INSTALLATION</b></p>	<p><b>2900.13</b></p>	

**INTENT & BENEFIT:**

THRUST BLOCKS ARE USED FOR LARGE PIPE SIZES OF 2 1/2" OR LARGER. A THRUST BLOCK IS A CONCRETE PIPE RESTRAINT THAT PREVENTS THE MAINLINE FROM MOVING BY TRANSFERRING PIPE LOADS (MAINLY DUE TO PRESSURE THRUST) TO A WIDER LOAD-BEARING SURFACE.

**NOTES:**

1. PROVIDE THRUST BLOCKS AT ALL CHANGES IN SIZE OR DIRECTION. BENDS, REDUCERS, PLUGS, AND THE OPPOSITE SIDE OF TEE BRANCHES ALL REQUIRE THRUST BLOCKS.
2. THE SIZE OF THE THRUST BLOCK IS DETERMINED BY THE WORKING PRESSURE, THE SIZE AND TYPE OF FITTING AND THE SOIL CONDITIONS AT THE JOB SITE. TO CALCULATE THE AREA OF CONTACT WITH THE SOIL, FOLLOW THESE STEPS:

CALCULATE THE TOTAL THRUST BY SELECTING THRUST/100 BY SIZE AND TYPE OF FITTING FROM TABLE 1 AND MULTIPLYING THRUST/100 BY SYSTEM PRESSURE DIVIDED BY 100. DIVIDE THE TOTAL THRUST BY THE BEARING CAPACITY OF THE SOIL IN EXCAVATION (FROM TABLE 2) TO DETERMINE THE AREA (IN SQUARE FEET) OF THRUST BLOCK REQUIRED TO BE IN CONTACT WITH THE UNDISTURBED SOIL.

**TABLE 1 THRUST/100 TABLE (POUNDS PER 100 PSI)**

SIZE INCHES	TEES PLUGS	90 BENDS	45 BENDS	22 BENDS
2 1/2	531	751	379	207
3	788	1114	562	207
4	1302	1841	928	307

**TABLE 2 SOIL BEARING CAPACITY**

SOIL TYPE	SAFE BEARING LOAD LBS PER SQ FT
SOFTCLAY	1,000
SAND	2,000
SAND AND GRAVEL	3,000
CEMENTED W/ CLAY	4,000
HARD PAN	10,000

THE ENGINEER IS RESPONSIBLE FOR DETERMINING SAFE BEARING LOADS. WHEN DOUBT EXISTS, SOIL BEARING TESTS SHOULD BE SPECIFIED.

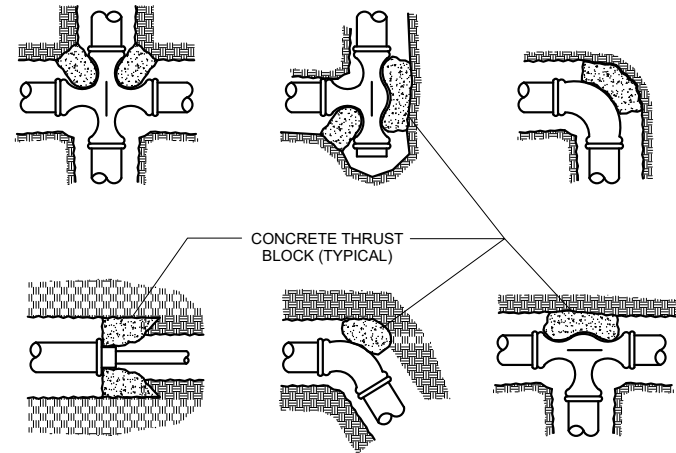

INSTALL MAIN LINE AS PER MANUFACTURERS INSTALLATION GUIDE. SIZE OF CONCRETE THRUST BLOCKS SHALL BE PER MANUFACTURERS INSTALLATION GUIDE.

NOT FOR CONSTRUCTION

© THIS DETAIL MAY NOT BE APPLICABLE IN ALL CIRCUMSTANCES AND IS PROVIDED FOR INFORMATIONAL PURPOSES ONLY. SPECIFIC SITE CONDITIONS AND SCHOOL/COMMUNITY REQUIREMENTS MUST BE TAKEN INTO CONSIDERATION. COPYRIGHT RETAINED JOINTLY BY THE OAKLAND UNIFIED SCHOOL DISTRICT AND TRUST FOR PUBLIC LAND. THIS DETAIL IS NOT TO BE REPRODUCED WITHOUT PERMISSION.

<p>OAKLAND UNIFIED SCHOOL DISTRICT Community Learning Through Standards</p>	<p>BAY TREE DESIGN</p>	<p>OUSD LIVING SCHOOLYARD STANDARD DETAILS</p>	DATE: OCTOBER 2022	NOT TO SCALE	DETAIL #
			<h1>THRUST BLOCKS</h1>		<h1>2900.14</h1>
<p>TRUST FOR PUBLIC LAND™</p>	<p>BROOKWATER</p>				

**INTENT & BENEFIT:**

THIS DETAIL SHOWS THE TYPICAL IRRIGATION MAINLINE, LATERAL LINE, WIRE, AND SLEEVING TRENCHING.

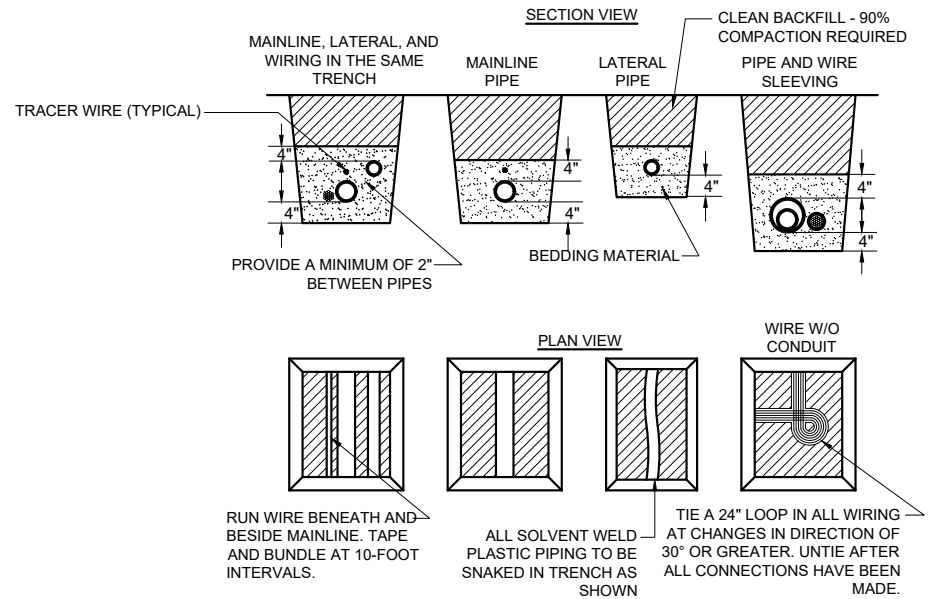

**NOTES:**

1. SLEEVE BELOW ALL HARDSCAPE ELEMENTS WITH SPECIFIED PVC PIPE TWICE THE DIAMETER OF THE PIPE OR WIRE BUNDLE WITHIN.
2. FOR PIPE AND WIRE BURIAL DEPTHS REFER TO IRRIGATION LEGEND AND SPECIFICATIONS.
3. INSTALL A COPPER-CLAD STEEL 14 AWG TRACER WIRE A MINIMUM OF 2" ABOVE THE ENTIRE MAINLINE EXCEPT INSIDE SLEEVES.



NOT FOR CONSTRUCTION

© THIS DETAIL MAY NOT BE APPLICABLE IN ALL CIRCUMSTANCES AND IS PROVIDED FOR INFORMATIONAL PURPOSES ONLY. SPECIFIC SITE CONDITIONS AND SCHOOL/COMMUNITY REQUIREMENTS MUST BE TAKEN INTO CONSIDERATION. COPYRIGHT RETAINED JOINTLY BY THE OAKLAND UNIFIED SCHOOL DISTRICT AND TRUST FOR PUBLIC LAND. THIS DETAIL IS NOT TO BE REPRODUCED WITHOUT PERMISSION.

 <p>OAKLAND UNIFIED SCHOOL DISTRICT Community Learning Through Students</p>	 <p>BAY TREE DESIGN</p>	<p>OUSD LIVING SCHOOLYARD STANDARD DETAILS</p>	DATE: OCTOBER 2022	NOT TO SCALE	DETAIL #
			<p><b>PIPE AND WIRE TRENCHING WITH TRACER WIRE</b></p>		<p><b>2900.15</b></p>

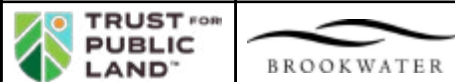

**INTENT & BENEFIT:**

THIS DETAIL SHOWS THE TYPICAL 3M DBY WIRE CONNECTOR INSTALLATION. THESE WIRE CONNECTORS ARE HIGH QUALITY WATER PROOF CONNECTORS. WHEN INSTALLED CORRECTLY, THEY PROVIDE EXCELLENT PROTECTION AGAINST WATER DAMAGE TO THE WIRES.

STEP 1: STRIP WIRES 1/2" FROM ENDS.

STEP 2: APPLY SCOTCHLOK Y SPRING CONNECTOR IN A CLOCKWISE DIRECTION.

STEP 3: INSERT SPLICE TO BOTTOM OF GEL-FILLED TUBE. CHECK TO MAKE SURE CONNECTOR HAS BEEN PUSHED PAST LOCKING FINGERS AND IS SEATED AT BOTTOM OF TUBE.

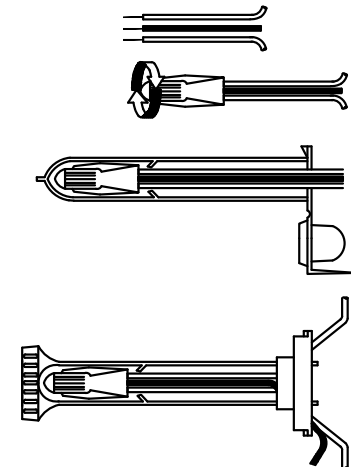

STEP 4: POSITION WIRES IN WIRE CHANNELS AND CLOSE INSULATOR TUBE COVER.



NOTE: MAXIMUM WIRE SIZES PER CONNECTOR ARE THREE # 14'S OR TWO #12'S.

NOT FOR CONSTRUCTION

© THIS DETAIL MAY NOT BE APPLICABLE IN ALL CIRCUMSTANCES AND IS PROVIDED FOR INFORMATIONAL PURPOSES ONLY. SPECIFIC SITE CONDITIONS AND SCHOOL/COMMUNITY REQUIREMENTS MUST BE TAKEN INTO CONSIDERATION. COPYRIGHT RETAINED JOINTLY BY THE OAKLAND UNIFIED SCHOOL DISTRICT AND TRUST FOR PUBLIC LAND. THIS DETAIL IS NOT TO BE REPRODUCED WITHOUT PERMISSION.

 <p>OAKLAND UNIFIED SCHOOL DISTRICT Community Learning Through Students</p>	<p><b>BAY TREE DESIGN</b></p>	<p>OUSD LIVING SCHOOLYARD STANDARD DETAILS</p>	<p>DATE: OCTOBER 2022</p>	<p>NOT TO SCALE</p>	<p>DETAIL #</p>
 <p>TRUST FOR PUBLIC LAND™</p>	 <p>BROOKWATER</p>		<p><b>WIRE CONNECTOR INSTALLATION</b></p>	<p><b>2900.16</b></p>	



**INTENT & BENEFIT:**

THIS DETAIL SHOWS THE TYPICAL 3M DBY WIRE CONNECTOR INSTALLATION. THESE WIRE CONNECTORS ARE HIGH QUALITY WATER PROOF CONNECTORS. WHEN INSTALLED CORRECTLY, THEY PROVIDE EXCELLENT PROTECTION AGAINST WATER DAMAGE TO THE WIRES.

STEP 1: STRIP WIRES 1/2" FROM ENDS.

STEP 2: APPLY SCOTCHLOK Y SPRING CONNECTOR IN A CLOCKWISE DIRECTION.

STEP 3: INSERT SPLICE TO BOTTOM OF GEL-FILLED TUBE. CHECK TO MAKE SURE CONNECTOR HAS BEEN PUSHED PAST LOCKING FINGERS AND IS SEATED AT BOTTOM OF TUBE.

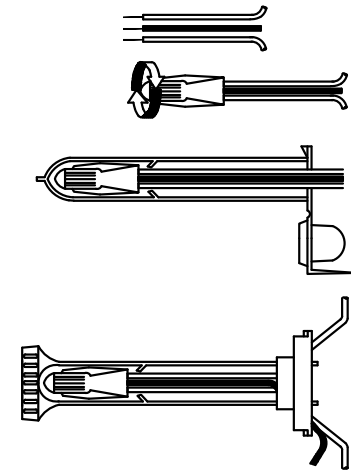

STEP 4: POSITION WIRES IN WIRE CHANNELS AND CLOSE INSULATOR TUBE COVER.



NOTE: MAXIMUM WIRE SIZES PER CONNECTOR ARE THREE # 14'S OR TWO #12'S.

NOT FOR CONSTRUCTION

© THIS DETAIL MAY NOT BE APPLICABLE IN ALL CIRCUMSTANCES AND IS PROVIDED FOR INFORMATIONAL PURPOSES ONLY. SPECIFIC SITE CONDITIONS AND SCHOOL/COMMUNITY REQUIREMENTS MUST BE TAKEN INTO CONSIDERATION. COPYRIGHT RETAINED JOINTLY BY THE OAKLAND UNIFIED SCHOOL DISTRICT AND TRUST FOR PUBLIC LAND. THIS DETAIL IS NOT TO BE REPRODUCED WITHOUT PERMISSION.

 <p>OAKLAND UNIFIED SCHOOL DISTRICT Community Learning Through Students</p>	<p>BAY TREE DESIGN</p>	<p>OUSD LIVING SCHOOLYARD STANDARD DETAILS</p>	<p>DATE: OCTOBER 2022</p>	<p>NOT TO SCALE</p>	<p>DETAIL #</p>
 <p>TRUST FOR PUBLIC LAND™</p>	 <p>BROOKWATER</p>		<p>WIRE CONNECTOR INSTALLATION</p>	<p>2900.16</p>	

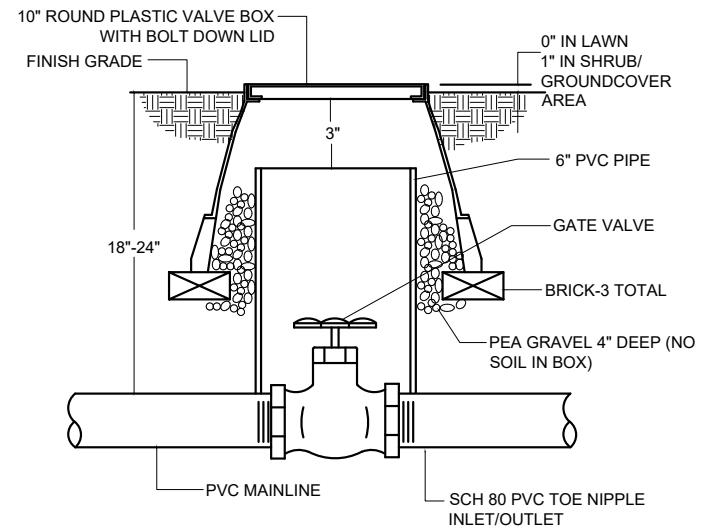

**INTENT & BENEFIT:**

GATE VALVES OR SHUT-OFF VALVES ARE USED TO ISOLATE SECTIONS OF MAINLINE FOR EASE OF MAINTENANCE. IF REPAIRS NEED TO BE MADE TO A SECTION OF THE SYSTEM, THE SHUT-OFF VALVE CAN BE CLOSED TO ALLOW REPAIR WITHOUT INTERRUPTING THE ENTIRE SYSTEM.



NOT FOR CONSTRUCTION

© THIS DETAIL MAY NOT BE APPLICABLE IN ALL CIRCUMSTANCES AND IS PROVIDED FOR INFORMATIONAL PURPOSES ONLY. SPECIFIC SITE CONDITIONS AND SCHOOL/COMMUNITY REQUIREMENTS MUST BE TAKEN INTO CONSIDERATION. COPYRIGHT RETAINED JOINTLY BY THE OAKLAND UNIFIED SCHOOL DISTRICT AND TRUST FOR PUBLIC LAND. THIS DETAIL IS NOT TO BE REPRODUCED WITHOUT PERMISSION.

 <p>OAKLAND UNIFIED SCHOOL DISTRICT Community Learning Through Students</p>	<p><b>BAY TREE DESIGN</b></p>	<p>OUSD LIVING SCHOOLYARD STANDARD DETAILS</p>	<p>DATE: OCTOBER 2022</p>	<p>NOT TO SCALE</p>	<p>DETAIL #</p>
 <p>TRUST FOR PUBLIC LAND™</p>	 <p>BROOKWATER</p>		<p style="text-align: center; font-size: 24pt;"><b>GATE VALVE</b></p>	<p style="text-align: center; font-size: 24pt;"><b>2900.17</b></p>	

**INTENT & BENEFIT:**

QUICK COUPLING VALVES ARE USED IN PLACE OF HOSE BIBS. QUICK COUPLING VALVES REQUIRE A SPECIAL KEY TO OPEN THE FLOW OF WATER. A HOSE SWIVEL IS PROVIDED FOR ATTACHING A HOSE. THEY ARE INSTALLED BELOW GROUND IN BOXES TO PROTECT THE VALVE AND KEEP THEM SAFE FROM VANDALISM.

**NOTES:**

1. CENTER VALVE IN BOX.
2. INSTALL QUICK COUPLING VALVES ON DOUBLE SWING JOINT ASSEMBLIES USING SCHEDULE 80 PVC RISERS AND FITTINGS.
3. THOROUGHLY FLUSH THE MAINLINE BEFORE INSTALLING THE VALVE.
4. INSTALL VALVE 12 INCHES FROM HARDSCAPE.

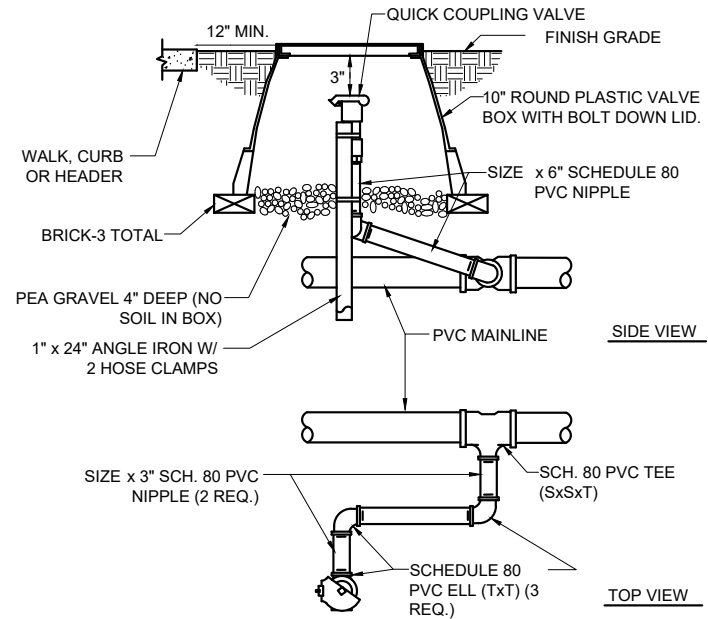

NOT FOR CONSTRUCTION

© THIS DETAIL MAY NOT BE APPLICABLE IN ALL CIRCUMSTANCES AND IS PROVIDED FOR INFORMATIONAL PURPOSES ONLY. SPECIFIC SITE CONDITIONS AND SCHOOL/COMMUNITY REQUIREMENTS MUST BE TAKEN INTO CONSIDERATION. COPYRIGHT RETAINED JOINTLY BY THE OAKLAND UNIFIED SCHOOL DISTRICT AND TRUST FOR PUBLIC LAND. THIS DETAIL IS NOT TO BE REPRODUCED WITHOUT PERMISSION.

<p>OAKLAND UNIFIED SCHOOL DISTRICT Community Learning Through Students</p>	<p><b>BAY TREE DESIGN</b></p>	<p>OUSD LIVING SCHOOLYARD STANDARD DETAILS</p>	<p>DATE: OCTOBER 2022</p>	<p>NOT TO SCALE</p>	<p>DETAIL #</p>
<p>TRUST FOR PUBLIC LAND™</p>	<p>BROOKWATER</p>		<p><b>QUICK COUPLING VALVE WITH ANGLE IRON SUPPORT</b></p>	<p><b>2900.18</b></p>	

**INTENT & BENEFIT:**

TREES ARE PROVIDED WITH SEPARATE IRRIGATION FROM OTHER SHRUBS AND GROUNDCOVERS. THIS IS TO ALLOW THE TREES TO BE IRRIGATED DURING SEVERE DROUGHT CONDITIONS. BUBBLERS PROVIDE IRRIGATION DIRECTLY TO THE ROOT BALL SAVING WATER WASTE DUE TO EVAPORATION.

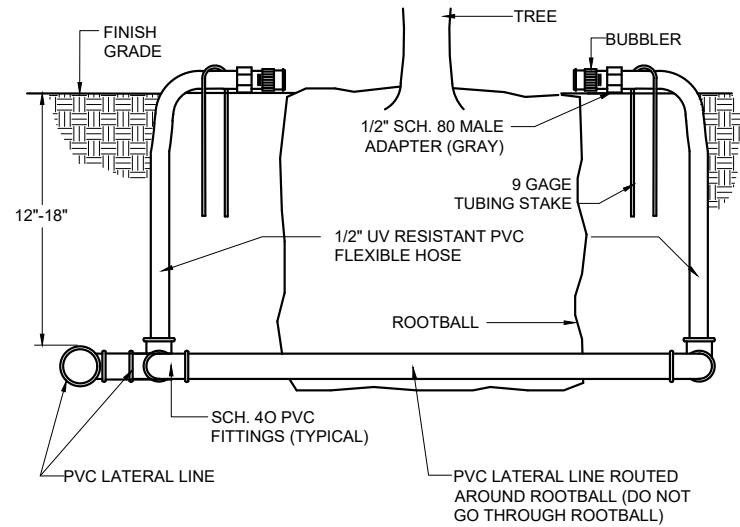

**NOTES:**

1. THOROUGHLY FLUSH THE LATERAL LINES BEFORE INSTALLING THE BUBBLERS.
2. INSTALL TWO BUBBLERS PER 15 GAL OR 24" BOX TREE, THREE BUBBLERS PER 36" BOX TREE, AND FOUR BUBBLERS PER 48" OR LARGER TREE.
3. INSTALL BUBBLER BETWEEN THE ROOT BALL AND NATIVE SOIL.
4. STAKE TUBING TO GROUND WITH U SHAPED STAKES. TUBING SHALL BE PERPENDICULAR TO GRADE.
5. USE UV RESISTANT PVC HOSE ONLY.



NOT FOR CONSTRUCTION

© THIS DETAIL MAY NOT BE APPLICABLE IN ALL CIRCUMSTANCES AND IS PROVIDED FOR INFORMATIONAL PURPOSES ONLY. SPECIFIC SITE CONDITIONS AND SCHOOL/COMMUNITY REQUIREMENTS MUST BE TAKEN INTO CONSIDERATION. COPYRIGHT RETAINED JOINTLY BY THE OAKLAND UNIFIED SCHOOL DISTRICT AND TRUST FOR PUBLIC LAND. THIS DETAIL IS NOT TO BE REPRODUCED WITHOUT PERMISSION.

 <p>OAKLAND UNIFIED SCHOOL DISTRICT Community Learning Through Students</p>	<p><b>BAY TREE DESIGN</b></p>	<p>OUSD LIVING SCHOOLYARD STANDARD DETAILS</p>	<p>DATE: OCTOBER 2022</p>	<p>NOT TO SCALE</p>	<p>DETAIL #</p>
 <p>TRUST FOR PUBLIC LAND™</p>	 <p>BROOKWATER</p>		<p><b>TREE BUBBLERS</b></p>	<p><b>2900.19</b></p>	

**INTENT & BENEFIT:**

INDIVIDUAL BUBBLERS TO SHRUBS PROVIDE IRRIGATION DIRECTLY TO THE ROOT BALL SAVING WATER WASTE DUE TO EVAPORATION.

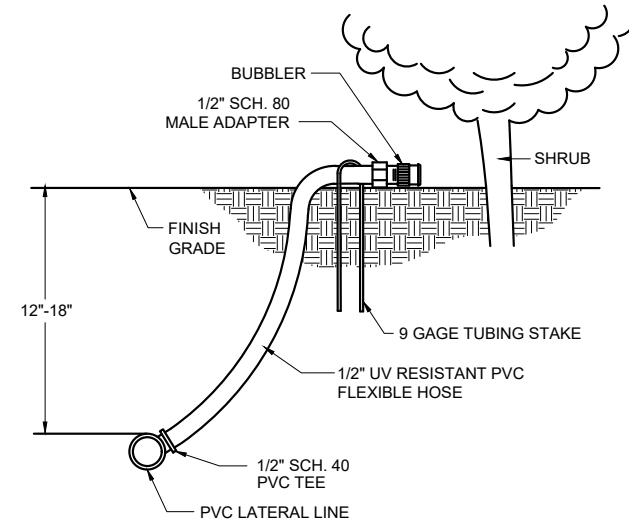

**NOTES:**

1. THOROUGHLY FLUSH THE LATERAL LINES BEFORE INSTALLING THE BUBBLERS.
2. INSTALL ONE BUBBLER PER SHRUB.
3. INSTALL BUBBLER BETWEEN THE ROOT BALL AND NATIVE SOIL. INSTALL ON UPHILL SIDE OF THE SHRUB.
4. STAKE TUBING TO GROUND WITH U SHAPED STAKES. TUBING SHALL BE PERPENDICULAR TO GRADE.
5. USE UV RESISTANT PVC HOSE ONLY.



NOT FOR CONSTRUCTION

© THIS DETAIL MAY NOT BE APPLICABLE IN ALL CIRCUMSTANCES AND IS PROVIDED FOR INFORMATIONAL PURPOSES ONLY. SPECIFIC SITE CONDITIONS AND SCHOOL/COMMUNITY REQUIREMENTS MUST BE TAKEN INTO CONSIDERATION. COPYRIGHT RETAINED JOINTLY BY THE OAKLAND UNIFIED SCHOOL DISTRICT AND TRUST FOR PUBLIC LAND. THIS DETAIL IS NOT TO BE REPRODUCED WITHOUT PERMISSION.

 <p>OAKLAND UNIFIED SCHOOL DISTRICT Community Schools. Strong Students.</p>	<p><b>BAY TREE DESIGN</b></p>	<p>OUSD LIVING SCHOOLYARD STANDARD DETAILS</p>	<p>DATE: OCTOBER 2022</p>	<p>NOT TO SCALE</p>	<p>DETAIL #</p>
 <p>TRUST FOR PUBLIC LAND™</p>	 <p>BROOKWATER</p>		<p><b>SHRUB BUBBLER</b></p>	<p><b>2900.20</b></p>	

**INTENT & BENEFIT:**

POP-UP SPRINKLERS WITH STANDARD OR ROTATING NOZZLES ARE TYPICALLY USED FOR TURF, HILLSIDES, AND BIORETENTION AREAS. POP-UP SPRINKLERS ARE ALSO USED FOR STREAM BUBBLER SYSTEMS IN DENSER SHRUB PLANTINGS.



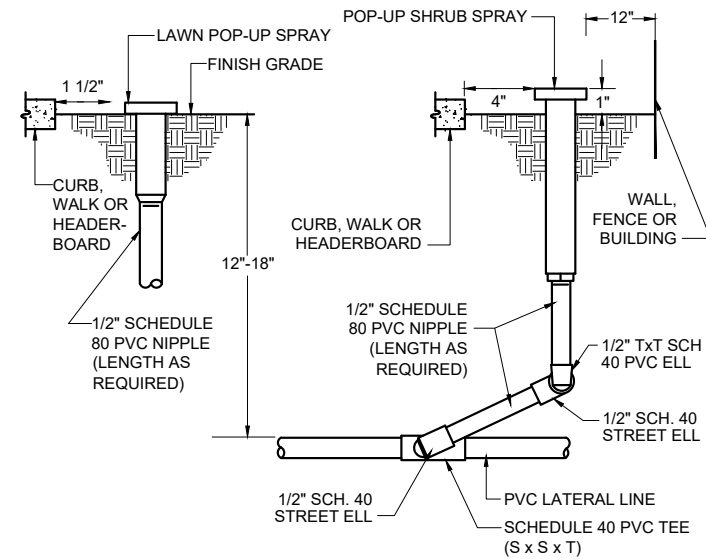

**NOTES:**

1. THOROUGHLY FLUSH THE LATERAL LINES BEFORE INSTALLING THE SPRINKLERS.
2. INSTALL SPRINKLERS ON SWING JOINTS. SWING JOINTS MAY BE PREFABRICATED BY LASCO, SPEARS, OR EQUAL.
3. SET SPRINKLER HEADS PERPENDICULAR TO GRADE EXCEPT ON HILLSIDES.
4. ADJUST SPRINKLER NOZZLES FOR PROPER DISTRIBUTION AND TRIM, PROVIDING COMPLETE COVERAGE WITH MINIMAL OVERSPRAY.



NOT FOR CONSTRUCTION

© THIS DETAIL MAY NOT BE APPLICABLE IN ALL CIRCUMSTANCES AND IS PROVIDED FOR INFORMATIONAL PURPOSES ONLY. SPECIFIC SITE CONDITIONS AND SCHOOL/COMMUNITY REQUIREMENTS MUST BE TAKEN INTO CONSIDERATION. COPYRIGHT RETAINED JOINTLY BY THE OAKLAND UNIFIED SCHOOL DISTRICT AND TRUST FOR PUBLIC LAND. THIS DETAIL IS NOT TO BE REPRODUCED WITHOUT PERMISSION.

 	 	OUSD LIVING SCHOOLYARD STANDARD DETAILS	DATE: OCTOBER 2022	NOT TO SCALE	DETAIL #
			<h1>POP-UP SPRINKLER</h1>		

**INTENT & BENEFIT:**

STREAM BUBBLER SYSTEMS ARE USED FOR DENSER SHRUB PLANTINGS WHERE BUBBLERS ARE NOT PRACTICAL.



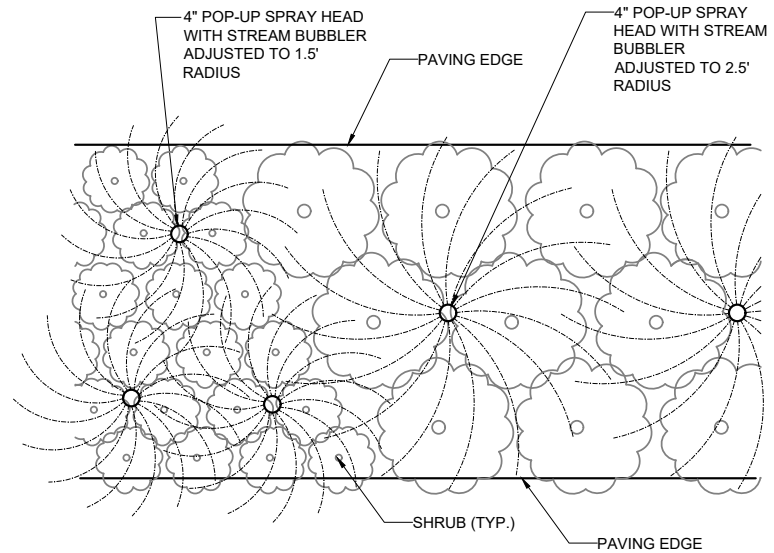

**NOTES:**

1. CONTRACTOR SHALL REDUCE THE RADIUS OF ALL STREAM BUBBLERS TO RADII SHOWN ABOVE BY CRANKING DOWN THE ADJUSTMENT SCREW ON TOP OF THE NOZZLE.
2. INSTALL POP-UP SPRINKLERS BETWEEN PLANTS AS SHOWN.



NOT FOR CONSTRUCTION

© THIS DETAIL MAY NOT BE APPLICABLE IN ALL CIRCUMSTANCES AND IS PROVIDED FOR INFORMATIONAL PURPOSES ONLY. SPECIFIC SITE CONDITIONS AND SCHOOL/COMMUNITY REQUIREMENTS MUST BE TAKEN INTO CONSIDERATION. COPYRIGHT RETAINED JOINTLY BY THE OAKLAND UNIFIED SCHOOL DISTRICT AND TRUST FOR PUBLIC LAND. THIS DETAIL IS NOT TO BE REPRODUCED WITHOUT PERMISSION.

 		OUSD LIVING SCHOOLYARD STANDARD DETAILS	DATE: OCTOBER 2022	NOT TO SCALE	DETAIL #
			<h2>TYPICAL STREAM BUBBLER LAYOUT</h2>		<h1>2900.22</h1>

**INTENT & BENEFIT:**

POP-UP ROTARY SPRINKLERS ARE USED FOR LARGE TURF PLAYFIELDS.

**NOTES:**

1. THOROUGHLY FLUSH THE LATERAL LINES BEFORE INSTALLING THE SPRINKLERS.
2. INSTALL SPRINKLERS ON SWING JOINTS. SWING JOINTS MAY BE PREFABRICATED BY LASCO, SPEARS, OR EQUAL.
3. SET SPRINKLER HEADS PERPENDICULAR TO GRADE EXCEPT ON HILLSIDES.
4. ADJUST SPRINKLER NOZZLES FOR PROPER DISTRIBUTION AND TRIM, PROVIDING COMPLETE COVERAGE WITH MINIMAL OVERSPRAY.

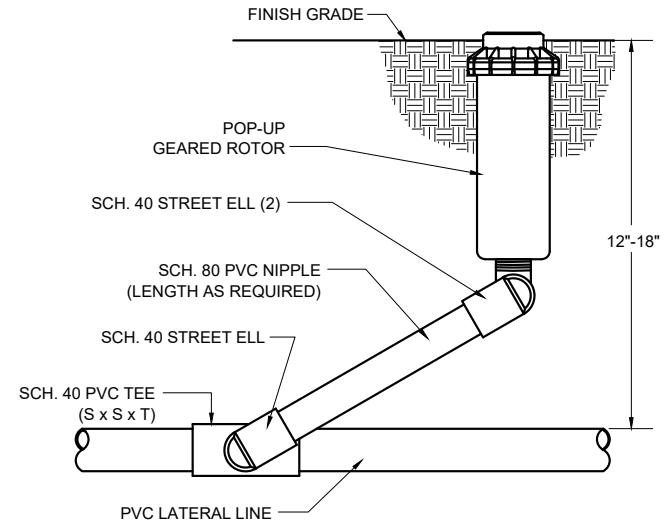

NOT FOR CONSTRUCTION



THIS DETAIL MAY NOT BE APPLICABLE IN ALL CIRCUMSTANCES AND IS PROVIDED FOR INFORMATIONAL PURPOSES ONLY. SPECIFIC SITE CONDITIONS AND SCHOOL/COMMUNITY REQUIREMENTS MUST BE TAKEN INTO CONSIDERATION. COPYRIGHT RETAINED JOINTLY BY THE OAKLAND UNIFIED SCHOOL DISTRICT AND TRUST FOR PUBLIC LAND. THIS DETAIL IS NOT TO BE REPRODUCED WITHOUT PERMISSION.



**BAY TREE DESIGN**

OUSD LIVING  
SCHOOLYARD  
STANDARD  
DETAILS

DATE: OCTOBER 2022

NOT TO SCALE

DETAIL #



**POP-UP TURF ROTOR**

**2900.23**



**INTENT & BENEFIT:**

12" POP-UP ROTARY SPRINKLERS ARE USED FOR HILLSIDE PLANTING OR TEMPORARY IRRIGATION.



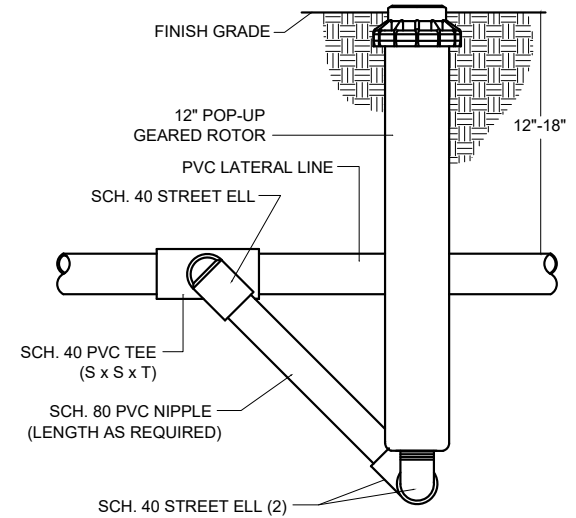

**NOTES:**

1. THOROUGHLY FLUSH THE LATERAL LINES BEFORE INSTALLING THE SPRINKLERS.
2. INSTALL SPRINKLERS ON SWING JOINTS. SWING JOINTS MAY BE PREFABRICATED BY LASCO, SPEARS, OR EQUAL.
3. SET SPRINKLER HEADS PERPENDICULAR TO GRADE EXCEPT ON HILLSIDES.
4. ADJUST SPRINKLER NOZZLES FOR PROPER DISTRIBUTION AND TRIM, PROVIDING COMPLETE COVERAGE WITH MINIMAL OVERSPRAY.



NOT FOR CONSTRUCTION

© THIS DETAIL MAY NOT BE APPLICABLE IN ALL CIRCUMSTANCES AND IS PROVIDED FOR INFORMATIONAL PURPOSES ONLY. SPECIFIC SITE CONDITIONS AND SCHOOL/COMMUNITY REQUIREMENTS MUST BE TAKEN INTO CONSIDERATION. COPYRIGHT RETAINED JOINTLY BY THE OAKLAND UNIFIED SCHOOL DISTRICT AND TRUST FOR PUBLIC LAND. THIS DETAIL IS NOT TO BE REPRODUCED WITHOUT PERMISSION.

 	 	OUSD LIVING SCHOOLYARD STANDARD DETAILS	DATE: OCTOBER 2022	NOT TO SCALE	DETAIL #
			<h2>12" POP-UP SHRUB ROTOR</h2>		

**INTENT & BENEFIT:**

HOSE BIBS ARE USED IN CIRCUMSTANCES WHERE THEY ARE PREFERRED OVER QUICK COUPLERS SUCH AS EDIBLE GARDENS. THEY ARE EASIER TO USE FOR CHILDREN.

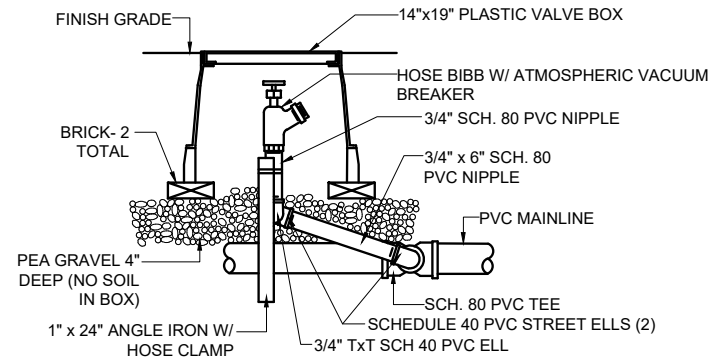

**NOTES:**

1. INSTALL HOSE BIB ON DOUBLE SWING JOINT ASSEMBLIES USING SCHEDULE 80 PVC RISERS AND FITTINGS.
2. THOROUGHLY FLUSH THE MAINLINE BEFORE INSTALLING THE HOSE BIB.
3. ATTACH A CHRISTY ENTERPRISES I.D. TAG ON HOSE BIB WHICH STATES: "WARNING - UNSAFE WATER - DO NOT DRINK", PART NO. 3040.
4. IF NEEDED, A SMALL HOSE MAY BE CONNECTED TO HOSE BIBB AND COILED IN THE VALVE BOX.
5. WHEEL HANDLE OF HOSE BIBB SHALL BE NO MORE THAN 3" BELOW BOX LID.



NOT FOR CONSTRUCTION

© THIS DETAIL MAY NOT BE APPLICABLE IN ALL CIRCUMSTANCES AND IS PROVIDED FOR INFORMATIONAL PURPOSES ONLY. SPECIFIC SITE CONDITIONS AND SCHOOL/COMMUNITY REQUIREMENTS MUST BE TAKEN INTO CONSIDERATION. COPYRIGHT RETAINED JOINTLY BY THE OAKLAND UNIFIED SCHOOL DISTRICT AND TRUST FOR PUBLIC LAND. THIS DETAIL IS NOT TO BE REPRODUCED WITHOUT PERMISSION.

 <p>OAKLAND UNIFIED SCHOOL DISTRICT Community Schools, Strong Students</p>	<p><b>BAY TREE DESIGN</b></p>	<p>OUSD LIVING SCHOOLYARD STANDARD DETAILS</p>	<p>DATE: OCTOBER 2022</p>	<p>NOT TO SCALE</p>	<p>DETAIL #</p>
 <p>TRUST FOR PUBLIC LAND™</p>	 <p>BROOKWATER</p>		<p><b>HOSE BIB IN VALVE BOX</b></p>	<p><b>2900.25</b></p>	

## APPENDIX B:

### Tree List

When developing a plant palette for a living schoolyard project, a school's greening committee or design professional can choose plants to consider interests and concerns from an adult's view—compliance with codes, low maintenance, durability, non-toxic, beauty—while also seeing the children's perspective and benefits. Plants provide children with: lessons about the natural world; props for creative and imaginary play; comfort and act as harbingers of change; a scale they can relate to; and a setting that fosters socializing and engagement.

The following lists in Appendices B: Tree List and C: Plant List are intended to provide any landscape professional who will be developing a planting plan, schoolyard landscaping retrofit or installing plants as part of the long-term “infrastructure” of a school site, with a plant list that includes all of the perspectives described above.

Tree and plant species have been selected based on the following criteria:

- species that give prominence to the regional character of the SF Bay Area,
- plants that enhance opportunities for teaching, learning and play,
- species that are climate appropriate for SF Bay Area—particularly Sunset Zone 17 with consideration given towards long-lived species and their suitability to a changing climate,
- climate resilient species,
- low maintenance plantings,
- and plants that are applicable to State and regional codes, rating systems, and best practices.

The trees and plant species in these lists are a starting point. Each school will want to add and adapt to this record. On each list, the plants are alphabetized by the botanical name. The tree list also includes the common name, evergreen/deciduous nature, general size categories, maximum expected height, maximum expected canopy, sun exposure requirement, Sunset Zone rating 17 suitability, Sunset Zone 24 rating suitability (the predicted zone for Oakland in 2099), relative water requirements, expected annual growth in inches, the potential for roots to damage infrastructure, and California native status.

Botanical Name	Common Name	Evergreen/ Deciduous	Size (S,M,L)	Max. Height (ft)	Max. Canopy (ft)	Sun Expo.	Zone 17	Zone 24	WUCOLS 2014	Avg. Growth Rate (in. / yr.)	Root Damage Potential	CA Native
Acacia stenophylla	Shoestring acacia	E	M	25	15	S	Y	Y	VL	36,0	U	
Acer buergerianum (Acer buergerianum)	Trident maple	D	M	20	20	PSh-S	Y	N	M	36,0	L	
Acer circinatum	Vine maple	D	M	20	15	Sh-PSh	Y	N	M	24,0	L	Y
Acer macrophyllum	Bigleaf maple	D	L	55	40	Sh-S	Y	Y	M	36,0		Y
Acer nigrum	Black maple	D	L	45	30	Sh-S	Y	N	-	24,0	M	
Acer palmatum	Japanese maple	D	M	20	20	Sh-PSh	Y	Y	M	18,0	L	
Acer rubrum cvs. (e.g. 'Brandywine, 'October Glory', 'Red Sunset')	Red maple	D	L	50	30	PSh-S	Y	N	M	36,0	M	
Aesculus californica	California buckeye	D	M	20	25	PSh-S	Y	Y	VL	24,0	L	Y
Afroparpus gracilior (Podocarpus gracilior)	Fern pine	E	M	30	15	PSh-S	Y	Y	M	18,0	L	
Agonis flexuosa	Peppermint tree	E	M	25	25	PSh-S	Y	Y	L	30,0	M	
Agonis flexuosa 'Jervis Bay After Dark'	After Dark peppermint tree								L	U	M	
Albizia julibrissin	Silk tree	PD	M	25	15	PSh-S	Y	N	L	36,0	M	
Allocasuarina verticillata (Casuarina stricta)	Drooping she-oak, coast beefwood	E	M	25	25	PSh-S	Y	Y	L	30,0	M	
Alnus rhombifolia	White alder	D	L	70	55	PSh-S	Y	N	H	81,5	H	Y
Arbutus unedo	Strawberry tree	E	M	25	25	Sh-S	Y	Y	L	18,0	L	
Arbutus x 'Marina'	Marina strawberry tree, hybrid madrone	E	L	40	30	S	Y	Y	L	18,0	L	
Arctostaphylos manzanita 'Dr. Hurd'	Dr. Hurd manzanita tree	E	S	15	15	PSh-S	Y	Y	VL	18,0	L	Y
Arctostaphylos refugionensis	Refugio manzanita								L	U		Y
Brachychiton acerifolius	Australian flame tree	PD	L	45	30	S	Y	Y	L	24,0		
Callistemon citrinus	Lemon bottlebrush	E	M	20	20	PSh-S	Y	Y	L	36,0	L	
Callistemon salignus	White bottlebrush	E	M	20	10	PSh-S	Y	Y	L	36,0	L	
Callistemon viminalis	Weeping bottlebrush	E	S	15	15	PSh-S	Y	Y	L	36,0	L	
Calocedrus decurrens (Libocedrus decurrens)	Incense cedar	E	L	70	10	PSh-S	Y	Y	M	18,0	M	Y

Botanical Name	Common Name	Evergreen/ Deciduous	Size (S,M,L)	Max. Height (ft)	Max. Canopy (ft)	Sun Expo.	Zone 17	Zone 24	WUCOLS 2014	Avg. Growth Rate (in. / yr.)	Root Damage Potential	CA Native
Casuarina cunninghamiana	River she-oak	E	L	55	25	PSh-S	Y	Y	L	30,0	L	
Casuarina stricta, see: Allocauarina verticillata												
Catalpa bignonioides	Common catalpa	D	M	30	30	Sh-S	Y	Y	M	30,0	M	
Catalpa speciosa	Western catalpa	D	L	45	30	Sh-S	Y	Y	L	30,0	M	
Ceanothus x 'Ray Hartman'	Ray Hartman ceanothus	E	S	15	15	PSh-S	Y	Y	L	30,0	L	Y
Cedrus atlantica	Atlas cedar	E	L	50	40	PSh-S	Y	Y	M	18,0	M	
Cedrus atlantica 'Glauca'	Blue atlas cedar	E	L	45	30	PSh-S	Y	N	M	18,0	M	
Cedrus deodara	Deodar cedar	E	L	45	25	PSh-S	Y	Y	L	36,0	M	
Cedrus libani	Cedar of Lebanon	E	L	75	75	PSh-S	Y	Y	L	12,0	L	
Celtis occidentalis	Common hackberry	D	L	60	40	Sh-S	Y	Y	L	30,0	M	
Celtis reticulata (Celtis laevigata var. reticulata)	Western hackberry, net-leaf hackberry	D	M	25	25	PSh-S	N	N	L	24,0	L	Y
Cercis canadensis	Eastern redbud	D	M	25	25	PSh-S	Y	Y	M	36,0	L	
Cercis occidentalis	Western redbud	D	S	15	15	PSh-S	Y	Y	VL	30,0	L	Y
Cercocarpus betuloides	Mountain mahogany	E	S	15	15	PSh-S	Y	Y	VL	24,0	L	Y
Chionanthus retusus	Chinese fringe tree	D	S	15	10	PSh-S	Y	Y	M	24,0	L	
Cinnamomum camphora	Camphor tree	E	L	50	45	PSh-S	Y	Y	M	24,0	H	
Cornus capitata	Evergreen dogwood	PD	M	30	30	Sh-PSh	Y	N	M	24,0	L	
Cornus nuttallii x florida 'Eddie's White Wonder'	Eddie's white wonder dogwood	D	M	30	25	Sh-S	Y	N	M	24,0	L	
Corylus colurna	Turkish hazel	D	L	55	25	PSh-S	Y	N	L	18,0	M	
Cupressus arizonica (C. a. arizonica), see: Hesperocyparis arizonica												
Cupressus arizonica glabra, see: Hesperocyparis glabra												
Cupressus forbesii, see: Hesperocyparis forbesii												
Cupressus sempervirens	Italian cypress	E	L	55	15	PSh-S	Y	Y	L	36,0	M	
Dodonaea viscosa	Hopseed bush	E	S	10	10	PSh-S	Y	Y	L	30,0	L	
Eriobotrya deflexa	Bronze loquat	E	M	20	20	PSh-S	Y	Y	M	36,0	L	

Botanical Name	Common Name	Evergreen/ Deciduous	Size (S,M,L)	Max. Height (ft)	Max. Canopy (ft)	Sun Expo.	Zone 17	Zone 24	WUCOLS 2014	Avg. Growth Rate (in. / yr.)	Root Damage Potential	CA Native
<i>Eucalyptus microtheca</i>	Coolibah	E	L	40	20	PSh-S	Y	Y	L	36,0	M	
<i>Eucalyptus nicholii</i>	Nichol's willow-leafed peppermint	E	L	40	30	PSh-S	Y	Y	L	81,5	M	
<i>Eucalyptus robusta</i>	Swamp mahogany	E	L	55	55	PSh-S	Y	Y	L	81,5	M	
<i>Eucalyptus sideroxylon</i>	Red ironbark	E	L	70	45	PSh-S	Y	Y	L	81,5	H	
<i>Eugenia myrtifolia</i> , see: <i>Syzygium borbonicum</i>										U		
<i>Fraxinus dipetala</i>	Foothill ash	D	M	20	15	PSh-S	Y	Y	L	24,0	L	Y
<i>Fraxinus oxycarpa</i> (F. <i>angustifolia</i> ) 'Raywood'	Raywood ash	D	L	40	25	PSh-S	Y	Y	M	24,0	M	
<i>Garrya elliptica</i>	Coast silktassel	E	S	10	10	PSh-S	Y	N	L	24,0	L	Y
<i>Geijera parviflora</i>	Australian willow	E	M	25	15	PSh-S	Y	Y	M	30,0	L	
<i>Ginkgo biloba</i> cvs. (e.g. 'Saratoga', 'Fairmont')	Ginkgo	D	L	50	20	PSh-S	Y	Y	M	18,0	M	
<i>Gleditsia triacanthos inermis</i>	Thornless honey locust	D	L	45	30	PSh-S	N	N	L	81,5	M	
<i>Gymnocladus dioica</i> 'Espresso'	Espresso Kentucky coffee tree	D	L	75	40	S	N	N	L	30,0	M	
<i>Harpephyllum caffrum</i>	South African wild plum, kaffir plum	E	L	40	40	PSh-S	N	Y	M	36,0	H	
<i>Hesperocyparis arizonica</i> ( <i>Cupressus arizonica</i> / <i>C. a. arizonica</i> )	Arizona or Cuyamaca cypress	E	M	30	15	S	Y	Y	VL	24,0	L	Y
<i>Hesperocyparis forbesii</i> ( <i>Cupressus forbesii</i> )	Tecate cypress	E	M	20	15	S	N	N	L	81,5	M	Y
<i>Heteromeles arbutifolia</i>	Toyon	E	M	20	10	PSh-S	Y	Y	L	18,0	L	Y
<i>Hymenosporum flavum</i>	Sweetshade	E	M	25	15	PSh-S	Y	N	M	18,0	L	
<i>Jacaranda mimosifolia</i>	Jacaranda	PD	L	40	25	S	Y	Y	M	36,0	U	
<i>Juglans hindsii</i>	California black walnut	D	L	45	45	PSh-S	Y	N	M	24,0	M	Y
<i>Juniperus chinensis</i> 'Torulosa'	Hollywood juniper	E	L	45	20	PSh-S	Y	Y	L	13,0	L	
<i>Juniperus chinensis</i> cvs. (e.g. 'Columnaris', 'Spartan', 'Wintergreen')	Chinese juniper (columnar tree forms)	E	L	45	20	PSh-S	Y	Y	L	18,0	L	

Botanical Name	Common Name	Evergreen/ Deciduous	Size (S,M,L)	Max. Height (ft)	Max. Canopy (ft)	Sun Expo.	Zone 17	Zone 24	WUCOLS 2014	Avg. Growth Rate (in. / yr.)	Root Damage Potential	CA Native
Juniperus scopulorum and cvs. (e.g. 'Admiral', 'Blue Haven', 'Blue Moon', 'Cologreen', 'Gracilis', 'Platinum', 'Spearmint', 'Sutherland' and 'Welchii')	Rocky Mountain juniper	E	S	15	10	PSh-S	Y	Y	L	24,0	L	
Koelreuteria bipinnata	Chinese flame tree	D	M	30	25	PSh-S	Y	Y	M	18,0	L	
Koelreuteria paniculata	Goldenrain tree	D	M	25	30	PSh-S	Y	Y	M	18,0	L	
Lagerstroemia 'Biloxi'	Hybrid crape myrtle	D	M	20	20	S	N	N	U	24,0	L	
Lagerstroemia 'Muskogee'	Hybrid crape myrtle	D	M	20	20	S	N	N	U	18,0	L	
Lagerstroemia 'Natchez'	Hybrid crape myrtle	D	M	20	20	PSh-S	N	N	U	18,0	L	
Lagerstroemia 'Tonto'	Hybrid crape myrtle								U	U		
Lagerstroemia 'Tuscarora'	Hybrid crape myrtle	D	M	20	15	PSh-S	N	N	U	24,0	L	
Lagerstroemia 'Tuskegee'	Hybrid crape myrtle								U	U		
Laurus nobilis and cvs (e.g. 'Saratoga')	Sweet bay, Grecian laurel	E	M	30	25	PSh-S	Y	Y	L	18,0	L	
Leptospermum laevigatum	Australian tea tree	E	M	25	25	PSh-S	Y	Y	L	24,0	L	
Libocedrus decurrens, see: Calocedrus decurrens												
Lophostemon confertus (Tristania conferta)	Brisbane box	E	L	40	25	PSh-S	Y	Y	M	30,0	M	
Lyonothamnus floribundus and ssp. asplenifolius	Catalina ironwood	E	M	30	15	PSh-S	Y	Y	L	24,0	M	Y
Magnolia grandiflora and cvs. (e.g. 'D.D. Blanchard', 'Little Gem', 'Majestic Beauty', 'Samuel Sommer', 'St. Mary')	Southern magnolia	E	Var.	Var.	Var.	Var.	Var.	Var.	M	Var.	Var.	
Magnolia grandiflora 'D.D. Blanchard'		E							U	U	U	
Magnolia grandiflora 'Little Gem'	Dwarf Southern Magnolia	E	S	15	10	PSh-S	Y	Y	U	12,0	L	
Magnolia grandiflora 'Majestic Beauty'	Southern magnolia	E	L	40	20	PSh-S	Y	Y	U	24,0	L	
Magnolia grandiflora 'Samuel Sommer'	Bull Bay	E	M	30	25	PSh-S	Y	Y	U	24,0	M	

Botanical Name	Common Name	Evergreen/ Deciduous	Size (S,M,L)	Max. Height (ft)	Max. Canopy (ft)	Sun Expo.	Zone 17	Zone 24	WUCOLS 2014	Avg. Growth Rate (in. / yr.)	Root Damage Potential	CA Native
Magnolia grandiflora 'St. Mary'		E	M	20	15	PSh-S	Y	Y	U	24,0	L	
Magnolia soulangeana 'Alba'	Saucer magnolia	D	M	20	20	PSh-S	Y	Y	U	24,0	L	
Magnolia soulangeana 'Alexandrina'	Saucer magnolia	D	M	20	20	PSh-S	Y	Y	U	24,0	L	
Magnolia soulangeana 'Lennei'	Saucer magnolia	D	M	20	20	PSh-S	Y	Y	U	30,0	L	
Magnolia stellata	Star magnolia	D	S	10	10	PSh-S	Y	Y	M	12,0	L	
Maytenus boaria	Mayten tree	E	L	40	25	PSh-S	Y	Y	M	24,0	M	
Melaleuca linariifolia	Flaxleaf paperbark	E	M	25	20	PSh-S	Y	Y	L	36,0	L	
Melaleuca nesophila	Pink melaleuca	E	M	25	25	PSh-S	Y	Y	L	36,0	L	
Melaleuca quinquenervia, see: M. viridiflora var. rubriflora												
Melaleuca viridiflora var. rubriflora (Melaleuca quinquenervia)	Cajeput tree	E	M	30	20	PSh-S	Y	Y	L	24,0	L	
Metasequoia glyptostroboides	Dawn Redwood	D	L	70	15	PSh-S	Y	Y	H	81,5	M	
Metrosideros excelsa (M. tomentosa)	New Zealand Christmas tree	E	M	25	25	PSh-S	Y	Y	L	24,0	M	
Morella californica (Myrica californica)	Pacific wax myrtle	E	M	25	25	PSh-S	Y	Y	M	24,0	L	Y
Morus alba 'Chaparral'	Chaparral fruitless mulberry	D	L	40	40	PSh-S	Y	Y	M	75,5	L	
Morus alba 'Fruitless'	Fruitless mulberry	D	M	25	35	PSh-S	N	Y	M	81,5	H	
Myrica californica, see: Morella californica												
Nyssa sylvatica	Tupelo	D	L	40	25	PSh-S	Y	N	M	18,0	L	
Olea europaea ('Swan Hill', 'Wilsoni', and other so-called fruitless cvs. only)	Fruitless olive	E	M	25	25	PSh-S	Y	Y	VL	24,0	M	
Oxydendrum arboreum	Sourwood, sorrel tree	D	L	45	25	PSh-S	Y	N	M	12,0	M	
Parkinsonia x 'Desert Museum'	Desert Museum Jerusalem thorn, Mexican palo verde	D	S	15	20	S	N	N	U	30,0	L	



Botanical Name	Common Name	Evergreen/ Deciduous	Size (S,M,L)	Max. Height (ft)	Max. Canopy (ft)	Sun Expo.	Zone 17	Zone 24	WUCOLS 2014	Avg. Growth Rate (in. / yr.)	Root Damage Potential	CA Native
<i>Parrotia persica</i>	Persian ironwood, Persian witch hazel	D	M	25	25	PSh-S	Y	N	M	18,0	L	
<i>Photinia x fraseri</i>	Fraser's photinia	E	S	15	10	PSh-S	Y	Y	M	30,0	L	
<i>Pinus canariensis</i>	Canary Island pine	E	L	60	25	PSh-S	Y	Y	L	36,0	M	
<i>Pinus coulteri</i>	Coulter pine	E	L	60	30	PSh-S	Y	N	L	30,0	M	Y
<i>Pinus edulis</i>	Pinyon pine, Colorado pinyon	E	M	25	20	PSh-S	Y	N	L	12,0	L	Y
<i>Pinus eldarica</i> (P. brutia eldarica)	Afghan pine	E	L	60	20	PSh-S	Y	Y	L	36,0	M	
<i>Pinus halepensis</i>	Aleppo pine	E	L	45	30	PSh-S	Y	Y	L	30,0	M	
<i>Pinus monophylla</i>	Single leaf pinyon pine	E	M	25	15	PSh-S	Y	N	L	12,0	L	
<i>Pinus montezumae</i>	Montezuma pine	E	L	75	20	PSh-S	Y	Y	L	30,0	M	
<i>Pinus pinea</i>	Italian stone pine	E	L	60	45	PSh-S	Y	Y	VL	30,0	M	
<i>Pinus thunbergiana</i>	Japanese black pine	E	M	25	25	PSh-S	Y	N	M	30,0	M	
<i>Pinus torreyana</i>	Torrey pine	E	L	40	20	PSh-S	Y	Y	L	36,0	M	Y
<i>Pistacia chinensis</i>	Chinese pistache	D	M	25	25	PSh-S	Y	N	L	24,0	L	
<i>Pittosporum angustifolium</i> (P. phillyraeoides)	Weeping pittosporum	E	M	20	10	PSh-S	Y	Y	M	12,0	L	
<i>Pittosporum eugenioides</i>	Tarata, lemonwood	E	M	30	10	PSh-S	Y	N	M	24,0	L	
<i>Platanus x acerifolia</i> (P. x hispanica) cvs. (e.g. 'Bloodgood', 'Columbia', 'Yarwood')	London plane tree	D	L	65	55	PSh-S	Y	Y	M	36,0	M	
<i>Podocarpus gracilior</i> , see: <i>Afrocarpus gracilior</i>												
<i>Podocarpus henkelii</i>	Long-leafed yellow- wood	E	M	25		PSh-S	Y	Y	M	24,0	L	
<i>Podocarpus macrophyllus</i>	Yew pine	E	L	40	15	PSh-S	Y	Y	M	24,0	L	
<i>Prunus caroliniana</i>	Carolina laurel cherry	E	M	25	20	PSh-S	Y	Y	L	36,0	L	
<i>Prunus cerasifera</i> cvs. (e.g. 'Kräuter Vesuvius', 'Newport', 'Purple Pony')	Purple-leaf plum	D	M	20	15	S	Y	N	L	30,0	L	
<i>Prunus ilicifolia</i> ssp. <i>lyonii</i>	Catalina cherry	E	M	25	25	PSh-S	Y	Y	L	24,0	L	Y

Botanical Name	Common Name	Evergreen/ Deciduous	Size (S,M,L)	Max. Height (ft)	Max. Canopy (ft)	Sun Expo.	Zone 17	Zone 24	WUCOLS 2014	Avg. Growth Rate (in. / yr.)	Root Damage Potential	CA Native
<i>Pseudotsuga menziesii</i>	Douglas fir	E	L	120	25	PSh-S	Y	N	L	24,0	M	Y
<i>Pyrus calleryana</i> 'Aristocrat' or 'Chanticleer'	Ornamental pear	D	L	40	40	S	Y	N	M	24,0	M	
<i>Quercus agrifolia</i>	Coast live oak	E	L	55	55	PSh-S	Y	Y	VL	24,0	U	Y
<i>Quercus chrysolepis</i>	Canyon live oak	E	L	55	25	PSh-S	Y	Y	VL	24,0	M	Y
<i>Quercus douglasii</i>	Blue oak	D	L	50	40	PSh-S	Y	Y	VL	12,0	L	Y
<i>Quercus durata</i>	Leather oak	E	S	10	10	PSh-S	Y	Y	VL	24,0	L	Y
<i>Quercus engelmannii</i>	Engelmann oak	D	L	50	90	PSh-S	Y	N	L	18,0	M	Y
<i>Quercus ilex</i>	Holly oak	E	L	45	45	PSh-S	Y	Y	L	24,0	L	
<i>Quercus lobata</i>	Valley oak	D	L	55	40	PSh-S	N	Y	L	30,0	M	Y
<i>Quercus rubra</i>	Red oak	D	L	60	55	PSh-S	Y	Y	M	30,0	M	
<i>Quercus shumardii</i>	Shumard red oak	D	L	55	30	PSh-S	Y	N	M	30,0	M	
<i>Quercus suber</i>	Cork oak	E	L	55	55	PSh-S	N	Y	L	30,0	M	
<i>Quercus tomentella</i>	Island oak	E	L	40	30	PSh-S	Y	Y	L	24,0	U	Y
<i>Quillaja saponaria</i>	Soapbark tree	E	M	35	20	S	Y	Y	L	12,0	L	
<i>Rhaphiolepis</i> 'Majestic Beauty'	Majestic Beauty rhaphiolepis	E	M	20	10	PSh-S	Y	Y	L	24,0	L	
<i>Rhus lancea</i> , see: <i>Searsia lancea</i>												
<i>Robinia x ambigua</i> 'Purple Robe'	Purple Robe locust	D	M	30	25	PSh-S	Y	Y	L	30,0	H	
<i>Sambucus mexicana</i>	Elderberry	D	S	10	10	S	Y	N	L	75,5	L	Y
<i>Searsia lancea</i> ( <i>Rhus lancea</i> )	African sumac	E	M	25	25	PSh-S	Y	Y	L	24,0	L	
<i>Sequoia sempervirens</i>	Coast redwood	E	L	75	25	PSh-S	Y	Y	H	81,5	L	Y
<i>Sophora japonica</i> , see: <i>Styphnolobium japonicum</i>												
<i>Stenocarpus sinuatus</i>	Firewheel tree	E	M	25	10	PSh-S	Y	Y	U	12,0	L	
<i>Styphnolobium japonicum</i> ( <i>Sophora japonica</i> )	Japanese pagoda tree	D	L	55	55	PSh-S	Y	Y	L	18,0	L	
<i>Syzygium australe</i> ( <i>S.</i> <i>paniculatum</i> , <i>Eugenia</i> <i>myrtifolia</i> )	Brush cherry, Australian brush cherry	E	M	30	15	Sh-S	Y	Y	M	12,0	M	

Botanical Name	Common Name	Evergreen/ Deciduous	Size (S,M,L)	Max. Height (ft)	Max. Canopy (ft)	Sun Expo.	Zone 17	Zone 24	WUCOLS 2014	Avg. Growth Rate (in. / yr.)	Root Damage Potential	CA Native
Syzygium paniculatum, see: Syzygium borbonicum												
Taxus spp.	Yew	E	L	40	20	Sh-S	Y	Y	L-M	12,0	M	
Tilia americana	American linden	D	L	50	20	S	Y	N	M	24,0	M	
Tilia cordata	Little-leaf linden	D	L	40	25	PSh-S	Y	N	M	18,0	M	
Tilia tomentosa	Silver linden	D	L	40	25	PSh-S	Y	N	L	18,0	M	
Tristania (Tristaniaopsis) laurina	Water gum	E	M	25	25	PSh-S	Y	Y	M	12,0	L	
Tristania conferta, see: Lophostemon confertus												
Ulmus parvifolia 'Drake', 'Athena'	Chinese elm	PD	M	35	40	PSh-S	Y	Y	U	81,5	M	
Umbellularia californica	California bay laurel	E	L	55	55	Sh-S	Y	Y	M	18,0	M	Y
Vitex agnus-castus	Chaste tree	D	S	10	15	PSh-S	Y	Y	L	24,0	L	
x Chitalpa tashkentensis	Chitalpa	D	M	25	25	PSh-S	Y	Y	L	36,0	L	Y
x Cupressocyparis leylandii	Leyland cypress	E	L	40	20	PSh-S	Y	Y	M	81,5	M	
Zelkova serrata	Sawleaf zelkova	D	L	50	50	PSh-S	Y	N	M	30,0	M	

**KEY:**

Evergreen/ Deciduous: E-Evergreen, D-Deciduous, PD-Partly Deciduous

Max. Height and Canopy: These sizes are adjusted to reflect the conditions of a typical schoolyard.

Sun Exposure: S-Full Sun, PSh-Part Shade, Sh-Shade, Var.-varies by species

Zone 17: trees designated with a 'Y' are suited to Sunset Climate Zone 17, the zone applicable to most of Oakland.

Zone 24: trees designated with a 'Y' are suited to Sunset Climate Zone 24, the zone anticipated to be applied to Oakland in the year 2099.

WUCOLS 2104: the Water Use Classification of Landscape Species applicable to Oakland. VL-Very Low, L-Low, M-Moderate, H-High, U-Unknown

Average Growth Rate (inches per year): These rates are adjusted to reflect the conditions of a typical schoolyard.

Root Damage Potential: Likelihood of a given tree to cause damage to surrounding infrastructure by its root system. L-low, M-Medium, H-High, U-Unknown

CA Native: Y-this plant is a California Native

Sources: Plants for Living Schoolyards SF Bay Area 2017; Los Angeles Unified School District approved plant list 2012; Sunset Western Garden Book; and SelectTree Database.

## APPENDIX C:

### Plant List

When developing a plant palette for a living schoolyard project, a school's greening committee or design professional can choose plants to consider interests and concerns from an adult's view—compliance with codes, low maintenance, durability, non-toxic, beauty—while also seeing the children's perspective and benefits. Plants provide children with: lessons about the natural world; props for creative and imaginary play; comfort and act as harbingers of change; a scale they can relate to; and a setting that fosters socializing and engagement.

The following lists in Appendices B: Tree List and C: Plant List are intended to provide any landscape professional who will be developing a planting plan, schoolyard landscaping retrofit or installing plants as part of the long-term “infrastructure” of a school site, with a plant list that includes all of the perspectives described above.

Tree and plant species have been selected based on the following criteria:

- species that give prominence to the regional character of the SF Bay Area,
- plants that enhance opportunities for teaching, learning and play,
- species that are climate appropriate for SF Bay Area—particularly Sunset Zone 17 with consideration given towards long-lived species and their suitability to a changing climate,
- climate resilient species,
- low maintenance plantings,
- and plants that are applicable to State and regional codes, rating systems, and best practices.

The trees and plant species in these lists are a starting point. Each school will want to add and adapt to this record. On each list, the plants are alphabetized by the botanical name. The tree list also includes the common name, evergreen/deciduous nature, general size categories, maximum expected height, maximum expected canopy, sun exposure requirement, Sunset Zone rating 17 suitability, Sunset Zone 24 rating suitability (the predicted zone for Oakland in 2099), relative water requirements, expected annual growth in inches, the potential for roots to damage infrastructure, and California native status.

Botanical Name	Common Name	CA Native	WUCOLS 2014	Invasive
<i>Abelia x grandiflora</i>	Glossy abelia		M	N
<i>Acca sellowiana</i> ( <i>Feijoa sellowiana</i> )	Pineapple guava		M	N
<i>Agonis flexuosa</i> 'Nana'	Dwarf peppermint tree		L	N
<i>Alyogyne huegelii</i> ( <i>Hibiscus huegelii</i> )	Blue hibiscus		L	N
<i>Amorpha californica</i>	False indigo	Y	L	N
<i>Arbutus unedo</i> 'Compacta'	Dwarf strawberry tree		L	N
<i>Arctostaphylos</i> spp. and cvs. (e.g. <i>A. manzanita</i> 'Dr. Hurd', <i>A. densiflora</i> 'Howard McMinn', <i>A. x 'Pacific Mist'</i> , <i>A. x. 'Sunset'</i> )	Manzanita (shrubs)	Y	VL - L	N
<i>Arctostaphylos</i> spp. and cvs. (e.g. <i>A. x 'Emerald Carpet'</i> , <i>A. uva-ursi</i> 'Anchor Bay')	Manzanita (groundcovers)	Y	M	N
<i>Artemisia californica</i> cvs. (e.g. 'Montara')	California sagebrush (groundcovers)	Y	L	N
<i>Artemisia x 'Powis Castle'</i>	Powis Castle hybrid sagebrush or wormwood		L	N
<i>Artemisia pycnocephala</i> and cvs. (e.g. 'David's Choice')	Sandhill sagebrush groundcovers	Y	L	N
<i>Artemisia tridentata</i>	Great Basin sagebrush, big sagebrush	Y	VL	N
<i>Asclepias californica</i>	California milkweed	Y	L	N
<i>Asclepias cordifolia</i>	Purple milkweed	Y	L	N
<i>Asclepias speciosa</i>	Showy milkweed	Y	L	N
<i>Aucuba japonica</i>	Japanese aucuba		M	N
<i>Baccharis pilularis</i> cvs. (e.g. 'Pigeon Point', 'Poza Surf')	Coyote brush (groundcovers)	Y	L	N
<i>Baccharis salicifolia</i> ( <i>B. glutinosa</i> , <i>B. viminea</i> )	Mulefat	Y	L	N
<i>Berberis</i> ( <i>Mahonia</i> ) <i>aquifolium</i>	Oregon grape	Y	M	N
<i>Berberis</i> ( <i>Mahonia</i> ) <i>aquifolium</i> 'Compacta'	Compact Oregon grape	Y	M	N
<i>Berberis</i> ( <i>Mahonia</i> ) <i>x 'Golden Abundance'</i>	Golden Abundance Oregon grape	Y	M	N
<i>Berberis</i> ( <i>Mahonia</i> ) <i>nervosa</i>	Longleaf barberry	Y	M	N
<i>Berberis</i> ( <i>Mahonia</i> ) <i>nevinii</i>	Nevin's barberry	Y	L	N
<i>Berberis</i> ( <i>Mahonia</i> ) <i>pinnata</i>	California barberry	Y	L	N
<i>Berberis</i> ( <i>Mahonia</i> ) <i>repens</i>	Creeping barberry	Y	L	N
<i>Buddleja</i> ( <i>Buddleia</i> ) <i> davidii</i>	Butterfly bush		M	Watch
<i>Buxus microphylla japonica</i>	Japanese boxwood		M	N
<i>Buxus sempervirens</i>	Common boxwood		M	N

Botanical Name	Common Name	CA Native	WUCOLS 2014	Invasive
Callistemon spp. and cvs. (e.g. 'Captain Cook', 'Little John')	Bottlebrush (shrubs)		L	N
Calothamnus quadrifidus	Common netbush, one-sided bottlebrush		L	N
Calycanthus occidentalis	Western spice bush	Y	M	N
Camellia japonica	Japanese camellia		M	N
Camellia sasanqua	Sun camellia		M	N
Carpenteria californica	Bush anemone	Y	M	N
Caryopteris x clandonensis and cvs. (e.g. 'Azure', 'Longwood', 'Worcester Gold')	Blue mist, bluebeard		M	N
Caryopteris incana	Common bluebeard		L	N
Ceanothus spp. and cvs. (e.g. 'Concha', 'Dark Star', 'Julia Phelps', 'Ray Hartman', and 'Skylark')	California wild lilac (shrubs)	Y	L	N
Ceanothus griseus horizontalis cvs. (e.g. 'Yankee Point')	California wild lilac (groundcovers) (e.g. Yankee Point Carmel creeper)		L	N
Cercis occidentalis	Western redbud	Y	VL	N
Cercocarpus betuloides	Mountain mahogany	Y	VL	N
Choisya ternata	Mexican orange blossom		M	N
Cistus spp. and cvs. (e.g. Cistus x pulverulentus 'Sunset', Cistus salviifolius)	Rockrose (groundcovers)		L	N
Cistus spp. and cvs. (e.g. Cistus ladanifer 'Blanche', Cistus x 'Victor Reiter')	Rockrose (shrubs)		L	N
Convolvulus cneorum	Bush morning glory		L	N
Coprosma repens	Mirror plant		M	N
Cordia parvifolia	Little-leaf cordia		U	N
Correa 'Dusky Bells' and other cvs.	Australian fuchsia		L	N
Cornus sericea	Dogwood	Y	H	N
Corylus cornuta californica	California hazelnut	Y	L	N
Cotinus coggygria and cvs.	Smoke tree		L	N
Cotoneaster damerri	Bearberry cotoneaster		L	N
Cotoneaster buxifolius (C. glaucophyllus)	Brightbead cotoneaster		L	N
Cotoneaster horizontalis	Rock cotoneaster		L	N
Cotoneaster salicifolius cvs. (e.g. 'Emerald Carpet', 'Repens')	Willowleaf cotoneaster (groundcovers)		L	N
Cuphea x 'David Verity'	Large firecracker plant		M	N

Botanical Name	Common Name	CA Native	WUCOLS 2014	Invasive
<i>Cuphea hyssopifolia</i>	False heather		M	N
<i>Cuphea micropetala</i>	Candy corn plant		M	N
<i>Diplacus</i> spp. - see <i>Mimulus</i> spp.				
<i>Dodonaea viscosa</i>	Hopseed bush		L	N
<i>Echium candicans</i> ( <i>E. fastuosum</i> )	Pride of Madeira		L	Limited
<i>Eriogonum arborescens</i>	Santa Cruz Island buckwheat	Y	VL	N
<i>Eriogonum fasciculatum</i>	California buckwheat	Y	L	N
<i>Eriogonum giganteum</i>	St. Catherine's lace		L	N
<i>Eriogonum grande</i> var. <i>rubescens</i>	Red buckwheat	Y	L	N
<i>Eriogonum umbellatum</i>	Sulfur buckwheat	Y	L	N
<i>Escallonia</i> spp. (e.g. <i>E. exoniensis</i> 'Frades')	Escallonia		M	N
<i>Eugenia myrtifolia</i> - see <i>Syzygium borbonicum</i>				
<i>Euryops pectinatus</i>	Gray-leaved euryops		L	N
<i>Fatsia japonica</i>	Japanese aralia		M	N
<i>Feijoa sellowiana</i> - see <i>Acca sellowiana</i>				
<i>Felicia amelloides</i>	Blue marguerite		M	N
<i>Frangula californica</i> ( <i>Rhamnus californica</i> )	Coffeeberry	Y	L	N
<i>Fremontodendron</i> spp.	Flannel bush	Y	VL	N
<i>Fuchsia hybrida</i>	Fuchsia		M	N
<i>Gaultheria shallon</i>	Salal	Y	M	N
<i>Garrya elliptica</i>	Coast silktassel	Y	L	N
<i>Globularia x indubia</i>	Globe daisy		M	N
<i>Grevillea</i> spp. (e.g. <i>G. x 'Canberra'</i> ('Canberra Gem'), <i>G. juniperina</i> , <i>G. lavandulacea</i> , <i>G. x 'Mason's Hybrid'</i> , <i>G. victoriae</i> )	<i>Grevillea</i> (e.g. Canberra Gem <i>grevillea</i> , juniper <i>grevillea</i> , lavender <i>grevillea</i> , Mason's hybrid <i>grevillea</i> , and royal <i>grevillea</i> )		L	N
<i>Grewia occidentalis</i>	Lavender starflower		M	N
<i>Hakea laurina</i>	Pincushion hakea		L	N
<i>Hakea suaveolens</i>	Sweet-scented hakea		L	N
<i>Heteromeles arbutifolia</i>	Toyon	Y	L	N
<i>Hibiscus huegelii</i> - see <i>Alyogyne huegelii</i>				

Botanical Name	Common Name	CA Native	WUCOLS 2014	Invasive
Hibiscus syriacus	Rose of Sharon		L	N
Hydrangea spp.	Hydrangea		M	N
Hydrangea quercifolia	Oakleaf hydrangea		M	N
Jasminum humile	Italian jasmine		L	N
Jasminum mesnyi	Primrose jasmine		L	N
Juniperus chinensis 'San Jose' and other cvs. (see Notes)	San Jose juniper		L	N
Juniperus procumbens 'Nana' and other cvs. (see Notes)	Japanese garden juniper		L	N
Juniperus sabina	Savin juniper		L	N
Lagerstroemia indica cvs. (e.g. 'Petite Orchid')	Crape myrtle (shrubs)		L	N
Lagerstroemia hybrids (shorter Indian series) (e.g. 'Acoma', 'Comanche', 'Hopi', 'Lipan', 'Pecos', 'Sioux', 'Yuma', 'Zuni')	Crape myrtle (shorter varieties)		L	N
Lavandula spp.	Lavender		L	N
Lavatera assurgentiflora	Tree mallow	Y	L	N
Leonotis leonurus (L. menthifolia)	Lion's tail		L	N
Leptospermum scoparium cvs.	New Zealand tea tree (shrubs)		L	N
Leucophyllum frutescens	Texas ranger		L	N
Leucophyllum laevigatum	Chihuahuan sage		L	N
Leucophyllum langmaniae 'Lynn's Legacy'	Lynn's Legacy leucophyllum			N
Leucospermum reflexum	Skyrocket pincushion		L	N
Ligustrum japonicum	Japanese privet, wax-leaf privet		M	N
Ligustrum japonicum 'Texanum' (L. texanum)	Compact wax-leaf privet		M	N
Loropetalum chinense	Fringe flower		L	N
Lupinus albifrons	Silver bush lupine	Y	VL	N
Mahonia spp. - see Berberis spp.				
Malacothamnus spp.	Bush mallow		VL - L	N
Melaleuca nesophila	Pink melaleuca		L	N
Mimulus (Diplacus) aurantiacus	Sticky monkeyflower	Y	VL	N
Mimulus (Diplacus) hybrids	Monkeyflower		L	N
Monardella villosa villosa	Coyote mint	Y	VL	N
Myrica (Morella) californica	Pacific wax myrtle	Y	M	N



Botanical Name	Common Name	CA Native	WUCOLS 2014	Invasive
<i>Myrsine africana</i>	African boxwood		L	N
<i>Myrtus communis</i>	Myrtle		L	N
<i>Myrtus communis</i> 'Compacta'	Dwarf myrtle		L	N
<i>Nandina domestica</i>	Heavenly bamboo		L	N
<i>Oemleria cerasiformis</i> ( <i>Osmaronia cerasiformis</i> )	Oso berry	Y	M	N
<i>Osmanthus fragrans</i>	Sweet olive		M	N
<i>Pelargonium x hortorum</i>	Common geranium		L	N
<i>Pelargonium peltatum</i>	Ivy geranium		L	N
<i>Perovskia</i> spp.	Russian sage		L	N
<i>Photinia fraseri</i>	Fraser's photinia		M	N
<i>Physocarpus capitatus</i>	Ninebark	Y	L	N
<i>Pittosporum eugenoides</i>	Tarata, lemonwood		M	N
<i>Pittosporum tobira</i>	Japanese pittosporum		L	N
<i>Plumbago auriculata</i>	Blue plumbago		L	N
<i>Prunus ilicifolia</i> ssp. <i>ilicifolia</i>	Hollyleaf cherry	Y	L	N
<i>Psidium cattleianum</i>	Strawberry guava		M	N
<i>Punica granatum</i> 'Nana'	Pomegranate		L	N
<i>Quercus durata</i>	Leather oak	Y	VL	N
<i>Rhamnus californica</i> - see <i>Frangula californica</i>				
<i>Rhamnus crocea</i>	Redberry	Y	L	N
<i>Rhaphiolepis indica</i>	India hawthorn		L	N
<i>Rhaphiolepis</i> x 'Majestic Beauty'	Majestic Beauty rhaphiolepis		L	N
<i>Rhaphiolepis umbellata</i>	Yedda hawthorn		L	N
<i>Rhus integrifolia</i>	Lemonadeberry	Y	L	N
<i>Rhus ovata</i>	Sugarbush	Y	L	N
<i>Ribes aureum</i>	Golden currant	Y	U	N
<i>Ribes malvaceum</i>	Chaparral currant	Y	VL	N
<i>Ribes sanguineum</i>	Red-flowering currant, pink-flowering currant	Y	L	N
<i>Ribes viburnifolium</i>	Catalina perfume, evergreen currant	Y	L	N

Botanical Name	Common Name	CA Native	WUCOLS 2014	Invasive
<i>Rosa floribunda</i> 'Iceberg'	White shrub rose	Y	M	N
<i>Rosa</i> hybrids	Rose		M	N
<i>Rosa</i> x <i>odorata</i> ( <i>Rosa</i> x <i>chinensis</i> ) 'Mutabilis'	Butterfly rose		M	N
<i>Rosa rugosa</i>	Rugosa rose		L	N
<i>Rosmarinus officinalis</i> cvs. (e.g. 'Huntington Carpet', 'Collingwood Ingram', and 'Prostratus')	Rosemary (groundcovers)		L	N
<i>Rosmarinus officinalis</i> cvs. (e.g. 'Blue Spires', 'Boule', 'Golden Rain')	Rosemary (shrubs)		L	N
<i>Salvia brandegei</i>	Santa Rosa Island sage, Brandegee's sage	Y	L	N
<i>Salvia chamaedryoides</i>	Germander sage		L	N
<i>Salvia clevelandii</i> 'Allen Chickering'	Allen Chickering Cleveland sage	Y	L	N
<i>Salvia clevelandii</i> 'Winifred Gilman'	Winifred Gilman Cleveland sage	Y	L	N
<i>Salvia greggii</i>	Autumn sage		L	N
<i>Salvia leucantha</i>	Mexican sage		L	N
<i>Salvia leucantha</i> 'Santa Barbara'	Santa Barbara Mexican sage		L	N
<i>Salvia leucophylla</i> cvs. (e.g. 'Amethyst Bluff', 'Point Sal Spreader')	Purple sage	Y	L	N
<i>Salvia mellifera</i>	Black sage	Y	L	N
<i>Salvia microphylla</i>	Cherry sage		L	N
<i>Salvia munzii</i>	Munz sage, San Diego sage	Y	L	N
<i>Salvia</i> x cvs. (e.g. <i>Salvia</i> x 'Aromas', <i>Salvia</i> x 'Pozo Blue')	Hybrid sage (various)		VL - M	N
<i>Sambucus mexicana</i>	Elderberry	Y	L	N
<i>Senecio mandraliscae</i>	(no common name)		L	N
<i>Sollya heterophylla</i>	Australian bluebell creeper		L	N
<i>Syzygium borbonicum</i> ( <i>S. paniculatum</i> , <i>Eugenia myrtifolia</i> )	Brush cherry, Australian brush cherry		M	N
<i>Syzygium paniculatum</i> - see <i>Syzygium borbonicum</i>				
<i>Taxus</i> spp.	Yew		M	N
<i>Ternstroemia japonica</i> ( <i>T. gymnanthera</i> )	Ternstroemia		M	N
<i>Teucrium cossonii</i>	Majorcan teucrium		VL	N
<i>Teucrium fruticans</i>	Bush germander		L	N
<i>Teucrium x lucidrys</i> ( <i>T. chamaedrys</i> )	Wall germander		U	N

Botanical Name	Common Name	CA Native	WUCOLS 2014	Invasive
Teucrium marum	Cat thyme		L	N
Tibouchina urvilleana	Princess flower		M	N
Trichostema lanatum	Woolly blue curls	Y	VL	N
Vaccinium ovatum	Huckleberry		M	N
Viburnum suspensum	Leatherleaf viburnum		M	N
Viburnum tinus	Laurustinus		M	N
Vitex agnus-castus	Chaste tree		L	N
Weigela florida	(no common name)		M	N
Westringia fruticosa	Coast rosemary		L	N
Xylosma congestum	Shiny xylosma		L	N

**KEY:**

*CA Native: Y-this plant is a California Native*

*WUCOLS 2104: the Water Use Classification of Landscape Species applicable to Oakland. VL-Very Low, L-Low, M-Moderate, H-High, U-Unknown*

*Invasive: Per the California Invasive Plant Council. N-not invasive, “watch”— risk for becoming invasive in the future, “limited”—can be invasive under certain conditions*

*Sources: Plants for Living Schoolyards SF Bay Area 2017; Los Angeles Unified School District approved plant list 2012; and Sunset Western Garden Book.*

## APPENDIX D

### Maintenance & Stewardship Resources

#### Key OUSD Stewardship Links

[OUSD School Gardens Toolkit](#)

[OUSD Vegetation Policy](#)

[OUSD Maintenance Plan](#)

[OUSD Maintenance Contract](#)

#### Resource Links

Life Lab: [School Garden Resources](#)

Life Lab: [Maintaining Your Garden](#)

Life Lab: [Running Effective Garden Workdays](#)

[School Garden Support Organization Network](#)

### Stewardship Challenges and Solutions

Despite our efforts to build relationships and support for living school grounds within a community, challenges will arise. Many common challenges are listed below. We offer some guidance on how to problem solve within your community in response.

#### a. Irrigation Issues

If an irrigation issue arises, depending on where and how an irrigation system was installed, OUSD Plumbing may need to be consulted. Submit a work order through your school's front office staff with a description of the problem and accompanying photo. If further consultation is needed to determine which department is needed, seek assistance from the OUSD Education and Community Programming Team at The Center.

If the your irrigation system was installed as part of a newly built living schoolyard or garden and is designated as part of an area that the school is responsible for, the irrigation may need to be fixed through other means.

*If irrigation challenges arise, consider the following:*

- Irrigation timer settings should be checked and may need to be tweaked based on current weather and day length.
- Check the power source or fuse boxes for your irrigation system(s). If irrigation systems are on a power supply that was turned off for any reason, this will cause obvious problems.

- Any batteries in the system should be checked every few months.
- Search for a relevant YouTube for repair suggestions.
- Check any warranties that may exist for your system if it is relatively new and part of a larger living schoolyard project.
- See assistance from the OUSD Education and Community Programming Team at The Center through the School Garden Infrastructure and Repair Form in the [OUSD School Gardens Toolkit](#).
- Hire a local irrigation contractor to help.

*To prevent and prepare for irrigation challenges:*

- Timer settings should be checked monthly to adjust to seasonal changes.
- Every August and June, all irrigation lines should be tested in all green areas to make sure everything is running smoothly.
- Ensure that the irrigation control box is locked to lower the risk of disturbance.
- Timer settings should be based on school schedules, especially outdoor lessons in the space. Irrigation timed to come on in the early evening instead of early morning will result in drier spaces for teachers and children first thing in the morning.
- Irrigation training, performed by another knowledgeable staff member or irrigation specialist, should happen with more than one community member each year.

### **b. Changes to Design**

The use of a living schoolyard will shed light on whether the original design was well thought-out or whether community needs have shifted.

Over time, changes to the design of a schoolyard may be necessary. In this case, it is important to work as a community to assess needs and desires and to come up with a plan. The plan should be simple and achievable and include steps for making the change.

### **c. Communication Breakdown**

Over time and due to changes in community make-up, communication channels can break down. It's important to come back to yearly rituals such as the OUSD Maintenance Contract and the designation of a "Person of Record" at each school, as well as intentionally passing on relationships and history as communities change. Consider creating an oral (recorded) or written history of your project and sharing it with your school community as well as the OUSD Education and Community Programming Team at The Center.

### **d. Drains**

Storm drains can get clogged in large rain events or from debris brought in by the wind. Covering drains with effective filters can help prevent larger clogs in the system's piping. Keeping drain areas clear of debris and generally keeping living schoolyard areas tidy will help address issues over time. Drain clearing can be a student-led routine task and creates an opportunity for students to learn about watersheds, stormwater runoff, pollution, and their role in keeping their watershed healthy..

### **e. Lack of Funding**

Schools with high free and reduced lunch populations may actually receive larger amounts of state or local funding. School communities

should advocate for a portion of these funds to be allocated to yearly living schoolyard maintenance. Schools with low free and reduced lunch populations may have higher fundraising capacity within the family community, and communities should advocate for a yearly stewardship budget within this context as well. Schools that have neither state/local funding nor family-raised funding face a harder time raising funds for their living schoolyard. However, over time relationships with local businesses, small grants, and small amounts of school budget can collectively support yearly living schoolyard stewardship activities.

#### **f. Lack of Interest**

Every school needs a champion for their living schoolyard. This champion needs to have the energy to support activities that bring others in, such as organizing a garden or living schoolyard committee, organizing workdays and parties, making a volunteer schedule, etc. This champion needs to change every few years to avoid burnout, but having at least one consistent person to support and move along community-building activities is critical.

#### **g. Overwhelming Weeds**

It is important to remember that living schoolyards need to be safe for children (and other species) and only organic methods of weed control should be used. In order to prevent and address areas with overwhelming amounts of weeds, consider the following:

- Weeding frequently, especially during the rainy fall with student help, will keep weeds at bay.
- Weeding is an important stewardship task for students to experience. Tackle small areas of weeds each week, or engage

students in a large sheet mulching activity.

- Weeds can be an opportunity for a hands-on science lesson. Make sure teachers know where weeds can be pulled and studied.
- Pulling large patches of weeds is can a great task for a workday and results in deep satisfaction for all involved.
- Sheet mulching large areas with a minimum of two inches of material (start with cardboard, and then add woodchips, straw, compost, or soil) after weeding will keep future weeds in control.
- OUSD Gardeners should be consulted when weeds are causing pest or safety issues.

#### **h. Pests**

It is important to remember that living schoolyards need to be safe for children (and other species) and only organic methods of pest control should be used. Consider the following in addressing pests in the living schoolyard:

- Purchasing ladybugs is rarely effective, as these wild-collected ladybugs tend to leave after release. It is more effective to encourage ladybugs and lacewings to come and stay in your garden by allowing minor aphid or whitefly infestations that then become food sources for these insect predators.
- Use the discovery of ‘pests’ as a learning opportunity. For example, larvae, including caterpillars, turn into butterflies, moths, and beetles. Capture some pests to see this lifecycle through.
- Engage students in collecting snails and slugs, or other pests.
- Many “pests” are actually part of the food chain for birds or beetles and can be left alone to provide better habitat. The living schoolyard and garden is a learning space, first and foremost.
- Pest issues often resolve themselves on their own if the spaces

are being managed ecologically. For example, broccoli and kale are often eaten by cabbage moth caterpillars, and in an organic garden, wasps may naturally come and quickly eat the caterpillars.

- Consult the OUSD School Gardens Toolkit for more information on Integrated Pest Management (IPM) techniques.

### **i. Interpersonal Dynamics and Inclusion**

Like any workplace, there can be challenging interpersonal dynamics within school communities. Depending on how successfully a school has included all voices in decision making related to the living schoolyard, community members can feel included or excluded. Lingering feelings of exclusion can lead to challenging dynamics that can become barriers that last for years if left unattended. It is important to involve all voices in living schoolyard design and stewardship and to build trust and a sense of mutual understanding among stakeholders, as best you can.

### **j. Permanent School Closures**

Declining enrollment can cause schools to close and living schoolyard and garden projects to be abandoned. If a school closure happens, the community should plan for the garden's closure as well. Key steps might include:

- Irrigation shut off
- Plant harvesting and/or transfer
- Infrastructure transfer to other school sites
- Mulching
- Securing of site

Consult with the OUSD Education and Community Programming Team at The Center to determine whether items that are left behind at closed sites can be used at other schools or can be added to the resource library at The Center.

### **k. Rainwater Harvesting Systems**

Cisterns require maintenance every season to ensure proper and safe functioning. The responsible party for this maintenance must be identified before a cistern is installed.

- Keep gutters free of debris, especially leaves during the fall. Inspect and clear gutters (twice a year) and screens on a regular basis (quarterly) and after rain events. (Especially if you have trees near your system.)
- Connection Points: Check connection points for leaks on ongoing basis and fix as necessary (tank, pipes, valves, & downspout) Make sure pipes are not bent, broken, or disconnected.
- Annual Tank Flushing: Drain and wash out the rainwater cistern once a year before rainy season begins. Schedule this activity on a fall clean-up day in September or October. This activity should happen when the tank is nearly empty so that rainwater is not wasted. The goal is to get rid of silt build-up at the bottom of the tank. Drain the tank from the bottom and rinse inside of tank with a hose at the top of the tank to flush the tank.
- Ensure that excess water (overflow) does not puddle/pool and drains away from buildings into storm drain systems or pervious terrain (after rain events).
- Provide conspicuous signage indicating that water in the collection tanks is not potable.
- Use rainwater on a regular basis during the winter rainy season so that as much as possible is diverted from the rainwater catchment system. Go beyond the capacity of your tank size by moving more water through the system.

- Incorporate rainwater into ongoing garden activities so that the system is consistently in use and problems are more readily identified and mitigated.
- Include rainwater system maintenance in yearly PTA/school community workdays, such as fall and spring clean-ups. (Twice a year)
- Communicate site-specific system information related to the school's rainwater harvesting system to future users so that knowledge is passed down as experts move on.
- Report any maintenance concerns that cannot be addressed by the site to The Education and Community Programming Team at The Center. The school community needs to maintain its rainwater harvesting system whether or not the system is in use.
- Observation: When it rains, check out your system to see how it is functioning. Look for leaks, make sure first flush diverter is working correctly, make sure that rainwater is being diverted to the tank, watch overflow.

### **I. Temporary School Closures**

Plan in advance for your living schoolyard needs during spring and summer break. Check all irrigation to make sure it is working. Set timings based on anticipated weather. Organize volunteers to regularly stop by and check on things (once a week may be enough). Designate a contact person if irrigation breaks over the summer and emergency repairs are needed. To plan for summer, please consult the [OUSD School Gardens Toolkit](#) for planning materials.

### **m. Trash and Debris**

Inevitably there will be trash and litter to pick up on school sites. This is a great job for students to do as part of stewardship routines that are built into an outdoor lesson on pollution or environmental stewardship or other part of the school day. Student stewardship routines are critical to the long-term success and maintenance of a living schoolyard space. Community workdays are a great way to tackle larger trash or debris issues. Find a community member with a truck who can haul large amounts of debris to the local recycling center, creative reuse center, or landfill.

### **n. Vandalism**

Depending on where your school is located, you can encounter vandalism in the living schoolyard. It is important to have a durable locked storage area to secure valuable items. Removable water spigots should be made available in case water sources need to be secured. Any irrigation systems should be locked. A motion detector light can be installed in areas with consistent issues. Working with neighbors to set up a neighborhood watch can help schools stay informed as to campus activity while school is not in session. Replacement of damaged items due to vandalism should be included in the yearly stewardship budget.

### **o. Violence and Lack of Safety**

Most schools are now implementing lock-down training and drills due to the threat of violence. Any plan, training, and drill should include protocols for all outdoor spaces and anyone teaching or learning in these spaces. Any first aid or disaster kits that are made available to teachers inside the school should also be made available in the living schoolyard.



## APPENDIX E

### **Living Schoolyards: The Why**

For an excellent overview of the benefits of living schoolyards, please read [“The Power and Potential of Green Schoolyards”](#) by Green Schoolyards America.

## APPENDIX F

### Reference Index

<b>accessibility (ADA)</b>	<u>5</u> , <u>12</u> , <u>14</u> , <u>22</u> , <u>26-27</u> , <u>29-38</u> , <u>42</u> , <u>45</u> , <u>47-58</u> , <u>61-62</u> , <u>69</u> , <u>74</u> , <u>93-97</u> , <u>99</u> , <u>101-102</u> , <u>105</u>	<b>boulders</b>	<u>10</u> , <u>21</u> , <u>50-52</u> , <u>55-56</u> , <u>64</u> , <u>91</u> , <u>105-106</u>
<b>active play</b>	<u>18</u> , <u>28</u> , <u>34</u> , <u>38</u> , <u>57</u> , <u>63</u> , <u>66-70</u>	<b>child development</b>	<u>6-7</u> , <u>9-12</u> , <u>29-30</u> , <u>51</u> , <u>62-63</u>
<b>air temperatures / heat / urban heat island</b>	<u>15</u> , <u>30-31</u> , <u>34-35</u> , <u>38</u> , <u>49</u> , <u>51</u> , <u>66</u> , <u>95</u> , <u>99-100</u>	<b>CHPS SRI Values</b>	<u>31-35</u> , <u>38-39</u> , <u>42-43</u> , <u>50</u> , <u>94-96</u>
<b>Albedo</b>	<u>93</u> , <u>96</u>	<b>cistern</b>	<u>27-28</u> , <u>72</u> , <u>89-90</u> , <u>160</u>
<b>amphitheater seating</b>	<u>20</u> , <u>29</u>	<b>climate resilience</b>	<u>12</u> , <u>14</u> , <u>19</u> , <u>26</u> , <u>30</u> , <u>42</u> , <u>48</u> , <u>66</u> , <u>140</u>
<b>Asphalt concrete</b>	<u>25</u> , <u>27-28</u> , <u>30</u> , <u>33</u> , <u>34</u> , <u>38</u> , <u>92</u>	<b>climbing</b>	<u>29</u>
<b>ball play</b>	<u>18</u> , <u>28</u> , <u>38</u> , <u>60</u> , <u>63</u> , <u>67</u> , <u>110</u>	<b>community</b>	<u>12</u> , <u>15</u> , <u>20</u> , <u>49</u> , <u>72</u> , <u>76</u>
<b>Ball play fencing</b>	<u>60</u> , <u>110</u>	<b>concrete paving</b>	<u>27</u> , <u>31</u> , <u>33</u> , <u>92</u>
<b>Bike parking</b>	<u>48</u> , <u>53</u>	<b>borkeen / engineered cork surfacing</b>	<u>27</u> , <u>34</u> , <u>44-45</u>
<b>bioretention basin / bioretention planter</b>	<u>28</u> , <u>53</u> , <u>88</u> , <u>91</u>	<b>counters</b>	<u>48-49</u> , <u>101</u>
<b>bioswale</b>	<u>28</u> , <u>90</u>	<b>decomposed granite (DG)</b>	<u>26-27</u> , <u>33-36</u> , <u>95</u> , <u>97</u> , <u>99</u>
		<b>Division of State Architects (DSA)</b>	<u>74-78</u> , <u>101</u> , <u>48</u> , <u>50</u> , <u>53-54</u> , <u>64</u>

<b>drainage</b>	<a href="#">15</a> , <a href="#">28-29</a> , <a href="#">35-38</a> , <a href="#">47</a> , <a href="#">54</a> , <a href="#">66</a>
<b>dry creekbed</b>	<a href="#">27-28</a> , <a href="#">53-54</a> , <a href="#">91</a>
<b>eating</b>	<a href="#">49</a>
<b>electrical access</b>	<a href="#">48</a> , <a href="#">57</a> , <a href="#">67</a>
<b>embankment slide</b>	<a href="#">29</a>
<b>emergency access / emergency egress</b>	<a href="#">26</a> , <a href="#">54</a> , <a href="#">59</a> , <a href="#">63</a> , <a href="#">67</a> , <a href="#">102-104</a>
<b>engineered wood fiber (EWF)</b>	<a href="#">26-27</a> , <a href="#">33</a> , <a href="#">36-38</a> , <a href="#">42</a> , <a href="#">45</a> , <a href="#">47</a> , <a href="#">97-99</a>
<b>equity</b>	<a href="#">6-7</a> , <a href="#">12-13</a> , <a href="#">30</a> , <a href="#">66</a>
<b>establishment fencing</b>	<a href="#">60</a> , <a href="#">113</a>
<b>fencing</b>	<a href="#">28</a> , <a href="#">59-61</a> , <a href="#">67</a> , <a href="#">92</a> , <a href="#">88</a> , <a href="#">95</a> , <a href="#">97-100</a> , <a href="#">110-113</a>
<b>garden</b>	<a href="#">15</a> , <a href="#">21</a> , <a href="#">53-54</a> , <a href="#">57-59</a> , <a href="#">74</a> , <a href="#">80-84</a>
<b>garden separator fence</b>	<a href="#">111</a> , <a href="#">60-61</a> , <a href="#">111</a>
<b>gathering spaces</b>	<a href="#">7</a> , <a href="#">10</a> , <a href="#">15</a> , <a href="#">20-21</a> , <a href="#">35</a> , <a href="#">48-49</a> , <a href="#">55</a> , <a href="#">105</a>
<b>Gravelpave2</b>	<a href="#">26-27</a> , <a href="#">33-36</a> , <a href="#">35-36</a> , <a href="#">92</a> , <a href="#">94</a>
<b>hose bib</b>	<a href="#">41</a> , <a href="#">44</a> , <a href="#">57-58</a> , <a href="#">70-71</a> , <a href="#">89-90</a> , <a href="#">132</a> , <a href="#">139</a>

<b>integrated curriculum</b>	<a href="#">7</a> , <a href="#">9-10</a> , <a href="#">15-16</a> , <a href="#">19</a> , <a href="#">21</a> , <a href="#">27-28</a> , <a href="#">31</a> , <a href="#">34</a> , <a href="#">38</a> , <a href="#">48-51</a> , <a href="#">55</a> , <a href="#">69</a> , <a href="#">72</a> , <a href="#">105-106</a>
<b>invasive species</b>	<a href="#">66</a>
<b>irrigation</b>	<a href="#">27-28</a> , <a href="#">38-41</a> , <a href="#">44</a> , <a href="#">57</a> , <a href="#">65</a> , <a href="#">68</a> , <a href="#">70-71</a> , <a href="#">80-82</a> , <a href="#">84-85</a> , <a href="#">89</a> , <a href="#">103</a> , <a href="#">114-115</a> , <a href="#">118-139</a> , <a href="#">157-161</a>
<b>landscaping</b>	<a href="#">65</a>
<b>leaf drop</b>	<a href="#">66-69</a>
<b>lighting</b>	<a href="#">48</a> , <a href="#">53</a> , <a href="#">67</a>
<b>logs</b>	<a href="#">10</a> , <a href="#">50-51</a> , <a href="#">55</a> , <a href="#">59</a> , <a href="#">107</a>
<b>loose play parts</b>	<a href="#">56-57</a> , <a href="#">62-64</a>
<b>loose surfacing material</b>	<a href="#">27</a> , <a href="#">30</a> , <a href="#">35-38</a> , <a href="#">42</a> , <a href="#">47</a> , <a href="#">60</a> , <a href="#">94-101</a> , <a href="#">111</a>
<b>maintenance</b>	<a href="#">7</a> , <a href="#">16</a> , <a href="#">25-36</a> , <a href="#">38-69</a> , <a href="#">66-70</a> , <a href="#">75-78</a> , <a href="#">79-85</a> , <a href="#">88-91</a> , <a href="#">93-100</a> , <a href="#">102</a> , <a href="#">107</a> , <a href="#">114-117</a> , <a href="#">131</a> , <a href="#">140</a> , <a href="#">149</a> , <a href="#">157-161</a>
<b>mulch / wood chips</b>	<a href="#">25</a> , <a href="#">27</a> , <a href="#">33</a> , <a href="#">37-38</a> , <a href="#">68-69</a> , <a href="#">81</a> , <a href="#">88</a> , <a href="#">92</a> , <a href="#">97-98</a> , <a href="#">105-106</a> , <a href="#">111-112</a> , <a href="#">114-115</a> , <a href="#">117</a> , <a href="#">127</a> , <a href="#">159-160</a>
<b>MWELo</b>	<a href="#">23</a> , <a href="#">69-71</a> , <a href="#">117</a>
<b>native ecologies</b>	<a href="#">7</a> , <a href="#">12</a> , <a href="#">14</a> , <a href="#">19</a> , <a href="#">65</a> , <a href="#">70</a> , <a href="#">72</a> , <a href="#">114-115</a> , <a href="#">140-156</a>

nature exploration area	<a href="#">19</a> , <a href="#">21</a> , <a href="#">53</a> , <a href="#">69</a> , <a href="#">105-109</a>
nature exploration elements	<a href="#">48</a> , <a href="#">53</a> , <a href="#">105-109</a>
OSD Central Kitchen, Instructional Farm and Garden, and Education and Community Center “The Center”	<a href="#">16</a> , <a href="#">54</a> , <a href="#">75</a> , <a href="#">78</a> , <a href="#">83-84</a> , <a href="#">157-161</a>
OSD Custodial Staff	<a href="#">2</a> , <a href="#">53</a> , <a href="#">57</a> , <a href="#">64</a> , <a href="#">67</a> , <a href="#">84</a>
OSD Garden Council	<a href="#">2</a> , <a href="#">51</a> , <a href="#">74</a> , <a href="#">83-84</a> , <a href="#">92</a> , <a href="#">97</a>
OSD Garden Stewards / Environment-Food-Garden (EFG) Champions	<a href="#">84</a> , <a href="#">54</a>
OSD Gardeners	<a href="#">67</a> , <a href="#">83</a> , <a href="#">158</a>
OSD Maintenance Contract	<a href="#">75</a> , <a href="#">78</a> , <a href="#">80</a> , <a href="#">84</a> , <a href="#">157-158</a>
OSD Maintenance Plan	<a href="#">75</a> , <a href="#">78</a> , <a href="#">80</a> , <a href="#">84</a> , <a href="#">157</a>
OSD Materials Standards	<a href="#">24</a>
OSD School Gardens Toolkit	<a href="#">23</a> , <a href="#">54</a> , <a href="#">74</a> , <a href="#">80</a> , <a href="#">102-103</a> , <a href="#">157-161</a>
OSD Teachers	<a href="#">2</a> , <a href="#">9</a> , <a href="#">16</a> , <a href="#">18</a> , <a href="#">28-29</a> , <a href="#">48</a> , <a href="#">75-76</a> , <a href="#">80</a> , <a href="#">82</a> , <a href="#">84-85</a> , <a href="#">158-159</a> , <a href="#">161</a>
OSD Vegetation Policy	<a href="#">23</a> , <a href="#">69-70</a> , <a href="#">80</a> , <a href="#">92</a> , <a href="#">97</a> , <a href="#">103</a> , <a href="#">157</a>
outdoor art space	<a href="#">21</a>
outdoor kitchen	<a href="#">21</a>

outdoor learning	<a href="#">9</a> , <a href="#">15</a> , <a href="#">19</a> , <a href="#">21</a> , <a href="#">48</a> , <a href="#">50</a> , <a href="#">60</a> , <a href="#">94</a>
ParkTread	<a href="#">27</a> , <a href="#">33</a> , <a href="#">35</a> , <a href="#">91</a>
pathways / trails	<a href="#">22</a> , <a href="#">26</a> , <a href="#">29</a>
paving	<a href="#">22</a> , <a href="#">27</a> , <a href="#">30</a> , <a href="#">33</a>
permeable ground surface	<a href="#">14</a> , <a href="#">19</a> , <a href="#">26-47</a> , <a href="#">88</a> , <a href="#">92-100</a> , <a href="#">98-101</a>
permeable pavers / unit pavers	<a href="#">27-28</a> , <a href="#">33</a> , <a href="#">35</a> , <a href="#">93</a>
phytobuffering	<a href="#">66</a>
planters	<a href="#">48</a> , <a href="#">53</a>
play equipment	<a href="#">62-64</a> , <a href="#">67</a>
pollinator garden	<a href="#">53</a>
poured-in-place rubber (PIP rubber)	<a href="#">43</a> , <a href="#">45</a>
primary pathways	<a href="#">30</a>
pruning	<a href="#">67-70</a> , <a href="#">82-83</a> , <a href="#">92</a> , <a href="#">97</a> , <a href="#">114-115</a> , <a href="#">117</a>
rainwater	<a href="#">28</a> , <a href="#">89-90</a> , <a href="#">160-161</a> , <a href="#">160</a>
raised bed	<a href="#">60</a> , <a href="#">102-104</a>
resilient paving / safety surfacing	<a href="#">42</a>

<b>rootable soil</b>	<a href="#">67-70</a> , <a href="#">115</a>
<b>rubber tiles</b>	<a href="#">30</a> , <a href="#">43</a> , <a href="#">45</a>
<b>seating</b>	<a href="#">10</a> , <a href="#">15</a> , <a href="#">26</a> , <a href="#">29</a> , <a href="#">48</a> , <a href="#">50-56</a> , <a href="#">64</a> , <a href="#">105-109</a>
<b>secondary pathways</b>	<a href="#">30</a>
<b>shade</b>	<a href="#">7</a> , <a href="#">14</a> , <a href="#">19</a> , <a href="#">41-42</a> , <a href="#">44</a> , <a href="#">48</a> , <a href="#">50</a> , <a href="#">62</a> , <a href="#">65-69</a> , <a href="#">101</a> , <a href="#">114-115</a>
<b>signage</b>	<a href="#">28-29</a> , <a href="#">64</a> , <a href="#">72</a>
<b>sinks</b>	<a href="#">57</a>
<b>site furnishings</b>	<a href="#">48</a>
<b>site grading</b>	<a href="#">26</a>
<b>stewardship</b>	<a href="#">80-85</a>
<b>stock tanks</b>	<a href="#">54</a> , <a href="#">104</a>
<b>storage</b>	<a href="#">48</a> , <a href="#">56</a> , <a href="#">63-64</a>
<b>stormwater</b>	<a href="#">15</a> , <a href="#">27</a> , <a href="#">53</a> , <a href="#">60</a> , <a href="#">66</a> , <a href="#">88-91</a> , <a href="#">112</a>
<b>stormwater fence</b>	<a href="#">28</a> , <a href="#">60</a> , <a href="#">88</a> , <a href="#">112</a>
<b>stumps</b>	<a href="#">10</a> , <a href="#">50-51</a> , <a href="#">55</a> , <a href="#">108-109</a>
<b>supervision / sightlines</b>	<a href="#">29</a>
<b>surfacing</b>	<a href="#">22</a> , <a href="#">27</a> , <a href="#">30</a> , <a href="#">33</a>

<b>tables</b>	<a href="#">48-49</a> , <a href="#">101</a>
<b>topography</b>	<a href="#">31</a> , <a href="#">59</a>
<b>transfer systems</b>	<a href="#">26</a>
<b>tree &amp; plant protection</b>	<a href="#">66-70</a> , <a href="#">116</a>
<b>trees</b>	<a href="#">7</a> , <a href="#">10</a> , <a href="#">14</a> , <a href="#">19</a> , <a href="#">25</a> , <a href="#">41-42</a> , <a href="#">44</a> , <a href="#">48</a> , <a href="#">55</a> , <a href="#">60</a> , <a href="#">62-63</a> , <a href="#">65-69</a> , <a href="#">114-116</a> , <a href="#">133</a> , <a href="#">140-148</a>
<b>turf, artificial / artificial turf</b>	<a href="#">30</a> , <a href="#">39</a> , <a href="#">41</a> , <a href="#">44-45</a>
<b>turf, living / living turf</b>	<a href="#">38-39</a> , <a href="#">59-60</a>
<b>utilities, underground</b>	<a href="#">67</a> , <a href="#">88</a> , <a href="#">93</a> , <a href="#">96-97</a>
<b>vantage point</b>	<a href="#">29</a>
<b>vehicular access</b>	<a href="#">31-35</a> , <a href="#">38</a> , <a href="#">93-94</a> , <a href="#">96</a>
<b>waste stream bins / garbage cans</b>	<a href="#">48</a> , <a href="#">53</a>
<b>water access</b>	<a href="#">48</a> , <a href="#">57</a> , <a href="#">67</a>

## APPENDIX G

### Photo Credits

Pg.	No.	Description	Credit
1	1	<i>Hoover Elementary School, OUSD.</i>	Wanda Stewart, Common Vision
5	1	<i>Students working together at Hoover Elementary School, OUSD.</i>	Wanda Stewart, Common Vision
5	2	<i>Garden education board at Peralta Elementary School, OUSD.</i>	Sharon Danks, Green Schoolyards America
6	1	<i>Living ecosystems provide opportunities for educational engagement, Melrose Leadership Academy, OUSD.</i>	Kat Romo, OUSD
6	2	<i>Integrated art and living plants elevate schoolyards and signal to children that they are worthy, Sankofa United.</i>	FCSM
6	3	<i>Sensory plants at Sankofa United Elementary School, OUSD.</i>	Emma Greenberg-Bell, FoodCorps
9	1	<i>Outdoor classroom at The Center, OUSD.</i>	Kat Romo, OUSD
9	2	<i>Outdoor classroom at Hoover Elementary School, OUSD.</i>	Wanda Stewart, Common Vision
10	1	<i>Outdoor learning at Hoover Elementary School, OUSD.</i>	Wanda Stewart, Common Vision
12	1	<i>Student at Hoover Elementary School Garden, OUSD.</i>	Wanda Stewart, Common Vision
12	2	<i>Sensory plants at Markham Elementary School, OUSD.</i>	Citizen Film
12	3	<i>Safe place to look for friends.</i>	Lisa Howard, Bay Tree Design
14	1	<i>Forest planted over 50 years ago, Washington Elementary School, BUSD.</i>	Lisa Howard, Bay Tree Design
14	2	<i>Miyawaki forest planted in 2021, Martin Luther King Jr. Middle School, BUSD.</i>	Lisa Howard, Bay Tree Design
14	3	<i>Stormwater capture at Glenview Elementary School, OUSD.</i>	Kat Romo, OUSD
15	1	<i>JTA representing Warriors Community Foundation at Markham Elementary School, OUSD</i>	Amy Osborne

Pg.	No.	Description	Credit
15	2	<i>Community workday planting trees at Melrose Leadership Academy, OUSD.</i>	Trust for Public Land
15	3	<i>Gate designed by student &amp; built by local artist at Peralta Elementary School, OUSD.</i>	Lisa Howard, Bay Tree Design
16	1	<i>Caring for plants at Hoover Elementary School, OUSD.</i>	Wanda Stewart, Common Vision
18	1	<i>Redeveloped play yard at ICS-TCN Cesar Chavez, OUSD.</i>	Bothman
19	1	<i>Child with Swallowtail butterfly.</i>	Wanda Stewart, Common Vision
20	1	<i>Parents hang out at pick-up, Sequoia Elementary School, OUSD.</i>	Lisa Howard, Bay Tree Design
20	2	<i>Community gathers for event, Peralta Elementary School, OUSD.</i>	Sharon Danks, Green Schoolyards America
21	1	<i>Outdoor classroom at creek, John Muir, BUSD.</i>	Arran Schultz, Bay Tree Design
21	2	<i>Students in Hoover School Garden the day before lockdown – March 13, 2020.</i>	Wanda Stewart, Common Vision
21	3	<i>Outdoor classroom and garden, Lockwood STEAM Academy Elementary School, OUSD.</i>	Kat Romo, OUSD
22	1	<i>Path in Nature Exploration Area at Markham Elementary School, OUSD.</i>	Kat Romo, OUSD
25	1	<i>Students at Washington Elementary School, where 1/3 of the yard is asphalt, 1/3 wood mulch and 1/3 turf, BUSD.</i>	Lisa Howard, Bay Tree Design
27	1	<i>Demonstration cistern used to water garden at Marshall Elementary School, SFUSD.</i>	Bay Tree Design
27	2	<i>Dry Creek Bed in play area at Mercy Bush Park, Menlo Park.</i>	Lisa Howard, Bay Tree Design
27	3	<i>Play and paths designed for topography at Manzanita Rec Center, Oakland.</i>	Lisa Howard, Bay Tree Design
29	1	<i>Students preparing tiered planting beds at Bella Vista Elementary School, OUSD.</i>	Kat Romo, OUSD

Pg.	No.	Description	Credit
31	1	Solar calendar embedded in concrete near garden, Oxford Elementary School, BUSD.	Lisa Howard, Bay Tree Design
34	1	AC paving with painted colors at Markham Elementary School, OUSD.	Amy Osborne
34	2	Permeable pavers, La Entrada Middle School, Las Lomas Elementary School District.	Lauren Freels, Bay Tree Design
36	1	DG in Peralta Elementary School Kindergarten Yard, OUSD.	Lisa Howard, Bay Tree Design
36	2	Gravel/Pave in learning garden at Oxford Elementary School, BUSD.	Lisa Howard, Bay Tree Design
36	3	ParkTread at the Presidio, San Francisco.	Beth Brannigan, Bay Tree Design
37	1	Mini library and wood mulch, MetWest High School, OUSD.	Kat Romo, OUSD
37	2	Instruments, log bench & wood mulch at Markham Elementary School, OUSD.	Amy Osborne
41	1	AC paving and living turf at ICS-TCN Cesar Chavez Campus, OUSD.	Alison Petsod-Hixon
41	2	Living turf at ICS-TCN Cesar Chavez Campus, OUSD.	Trust for Public Land
41	3	Artificial turf at Markham Elementary School, OUSD.	Amy Osborne
42	1	Rubber tiles at Markham Elementary School, OUSD.	Amy Osborne
42	2	Mosaic Frog and poured-in-place rubber at Markham Elementary School, OUSD	Amy Osborne
47	1	Corkeen play surfacing with standing logs.	SPEC
47	2	Artificial turf at Sankofa United Elementary School, OUSD.	Lisa Howard, Bay Tree Design
47	3	Engineered wood fiber at ICS-TCN César Chávez Schools, OUSD.	Alison Petsod-Hixon
49	1	Tables and mosaic bench at ICS-TCN Cesar Chavez Campus, OUSD.	Trust for Public Land
49	2	Tables at Sankofa United Elementary School, OUSD.	Lisa Howard, Bay Tree Design
49	3	Counter at Wood Oven Prep area at The Center, OUSD.	Sarah Pipping, OUSD
51	1	Tree stumps at Markham Elementary School, OUSD.	Trust for Public Land

Pg.	No.	Description	Credit
51	2	Seating at Leonard R. Flynn Elementary School, SFUSD.	Lisa Howard, Bay Tree Design
51	3	Seating arranged to socialize., Mills College Children's School, Oakland.	Lisa Howard, Bay Tree Design
52	1	Tiled circular seating at Marshall Elementary School, SFUSD.	Lisa Howard, Bay Tree Design
52	2	Movable stump seating at The Center, OUSD.	Kat Romo, OUSD
54	1	DSA ADA approved planter at Oxford Elementary School, BUSD.	Lisa Howard, Bay Tree Design
54	2	Students at raised beds at The Center, OUSD.	Kat Romo, OUSD
54	3	Raised bed with seating at Sequoia Elementary School, OUSD.	Lisa Howard, Bay Tree Design
55	1	Students gathering on boulders at recess, Mills College Children's School, Oakland.	Lisa Howard, Bay Tree Design
55	2	Student hanging out on log at Markham Elementary School, OUSD	Trust for Public Land
55	3	Stump seating at Sankofa Elementary School, OUSD.	Lisa Howard, Bay Tree Design
56	1	Toolshed at MetWest High School, OUSD.	Kat Romo, OUSD
56	2	Tools organized in shed at MetWest High School, OUSD.	Kat Romo, OUSD
57	1	Outdoor sink at Montclair Elementary School, OUSD.	Kat Romo, OUSD
58	1	Fencing separating ball play areas from garden at Leonard R. Flynn Elementary School, SFUSD.	Lisa Howard, Bay Tree Design
59	1	Fencing demarcating stormwater area at Markham Elementary School, OUSD.	Lisa Howard, Bay Tree Design
59	2	Temporary plant protection fencing at ICS-TCN Cesar Chavez Campus, OUSD.	Kat Romo, OUSD
60	1	A range of play equipment and separator fencing at Oxford Elementary School, BUSD.	Lisa Howard, Bay Tree Design
60	2	Students creatively using hoop as "Shoe God" at Sequoia Elementary School, OUSD.	Lisa Howard, Bay Tree Design
61	1	Fences separate different play areas, ICS/TCN Cesar Chavez Campus, OUSD.	Trust for Public Land

Pg.	No.	Description	Credit
61	2	<i>Garden area protected from ball play and after-hours visits, Markham Elementary School, OUSD.</i>	Citizen Film
61	3	<i>Students till soil next to a garden separator fence, Melrose Leadership Academy, OUSD.</i>	Paige Green
62	1	<i>Loose gravel acts as play elements.</i>	Willa Caughey, Bay Tree Design
62	2	<i>Play opportunities within a living schoolyard at Sequoia Elementary School, OUSD.</i>	Lisa Howard, BTB
63	1	<i>Large loose parts foster collaboration and creative play.</i>	Lisa Howard, Bay Tree Design
64	1	<i>Harvesting in the garden on March 13, 2020. The last day before shutdown from the Pandemic, in the Hoover Elementary School garden.</i>	Wanda Stewart, Common Vision
65	1	<i>Plants provide scale, shade, and softness, Sankofa Elementary School, OUSD.</i>	Lisa Howard, Bay Tree Design
65	2	<i>Planting day at Brookfield Elementary School, OUSD.</i>	Kat Romo, OUSD
68	1	<i>Pollinator plants provide smells and visitors.</i>	Lauren Freels, Bay Tree Design
68	2	<i>Rainbow plants, Bridges Academy, OUSD.</i>	Kira Maritano, TPL
71	1	<i>Mosaic, Sequoia Elementary School, OUSD.</i>	Lisa Howard, Bay Tree Design
72	1	<i>Living schoolyard sign at Markham Elementary School, OUSD.</i>	Kat Romo, OUSD
72	2	<i>Handmade signs can set a welcoming tone.</i>	Kat Romo, OUSD
72	3	<i>Demonstration stormwater cistern sign at Skyline High School, OUSD.</i>	Kat Romo, OUSD
76	1	<i>Collaborative, hands-on design at Melrose Leadership Academy, OUSD.</i>	Trust for Public Land
76	2	<i>Ideas for the schoolyard at Markham Elementary, OUSD.</i>	Trust for Public Land
77	1	<i>Design workshop where students, teachers, family members, and community collaborate.</i>	Lisa Howard, Bay Tree Design
77	2	<i>Drawing from student workshop.</i>	Bay Tree Design